

EMERGENCY LED INVERTER INSTALLATION - WARNING

IMPORTANT SAFEGUARDS READ AND FOLLOW ALL SAFETY INSTRUCTIONS

When using electrical equipment, basic safety precautions should always be followed including the following:

- WARNING** – Read all product labels and instructions before installation.
- WARNING** – Turn off power before installation, inspection or removal.
- WARNING** – Installation and servicing should be done by qualified personnel only in accordance with the National Electrical Code and local regulations.
De-energize before opening.
- WARNING** – This unit provides more than one power supply connection point. To reduce the risk of electrical shock, disconnect both normal and emergency sources by turning off the A.C. branch circuit and by disconnecting the unit connector before servicing.
- WARNING** – Sealed unit. Battery not replaceable. Replace entire unit when necessary.
- WARNING** – This unit requires an unswitched power source of 120-277VAC, 50-60Hz.
- CAUTION** – DO NOT USE OUTDOORS
- CAUTION** – DO NOT MOUNT NEAR GAS OR ELECTRONIC HEATERS.
- CAUTION** – EQUIPMENT SHOULD BE MOUNTED IN LOCATIONS AND AT HEIGHTS WHERE IT WILL NOT BE SUBJECTED TO TAMPERING BY UNAUTHORIZED PERSONNEL
- CAUTION** – THE USE OF ACCESSORY EQUIPMENT NOT RECOMMENDED BY THE MANUFACTURER MAY CAUSE AN UNSAFE CONDITION.
- CAUTION** – DO NOT USE THIS EQUIPMENT FOR OTHER THAN ITS INTENDED USE
- CAUTION** – Use with grounded, UL Listed, damp location rated fixtures and case should be grounding.
- CAUTION** – The equipment is intended for ordinary locations and for permanent installation into one or more listed emergency luminaires.
- IMPORTANT** – Please charge the battery consistently for >24 hours for the first time usage so as to activate the whole battery cells of discharging/charging duration.
- IMPORTANT** – The products are produced with built-in batteries, which could be stocked for one year at most without being used. If clients keep them for more than one year, the batteries may be damaged. This is not covered in the warranty.
- IMPORTANT** – Device has to be checked and re-activated to keep emergency function after installation.

EMERGENCY LED INVERTER INSTALLATION GUIDE

Part 1 - Inverter installation:

1. Turn off power at the source.
2. Attach the emergency LED inverter to the fixture or ceiling, ensuring it doesn't interfere with existing hardware.
3. Ensure installation complies with local regulations.
4. If using switched power, ensure an unswitched line is available in the J-box or fixture wiring compartment.
5. If using unswitched constant power applications (emergency only), connect the incoming unswitched line to the unit's black wire and cap off the unit's black/white switched line.
6. Connect the flex conduit for line voltage to the J-box or fixture wiring compartment as per the wiring diagram. Pair the unit connector last to prevent electric shock.
7. Wire the test accessory plate according to the wiring diagram, ensuring correct connections for the indicator light and test switch.
8. Restore power at the source to complete the installation.

Refer to the Test Button & Indicator Light section below for testing and maintenance instructions.

Note: This emergency inverter is compatible only with GREEN CREATIVE or ILP products listed in the compatibility list.

Product Information:

Model No.	Input Voltage	Output Voltage (EM Mode)	Output Power (EM Mode)	Battery Pack	Duration (EM Mode)	Recharge Time
24EMINVERTER	100-277Vac 50/60Hz	120V AC	23.9W	LiFePO4 12.8V 4.5Ah	90 minutes	24 hours

- Suitable for LED products with a power range of 7W to 240W and 0-10V dimming capability. When dimming to 1V, ensure that the system power does not exceed 21W.
- LED products with powers between 7W and 24W that do not have the 0-10V dimming capability can also be used.
- For use in an operating environment ranging from 41°F / 5°C to 140°F / 60°C.
- Damp or wet location installation.

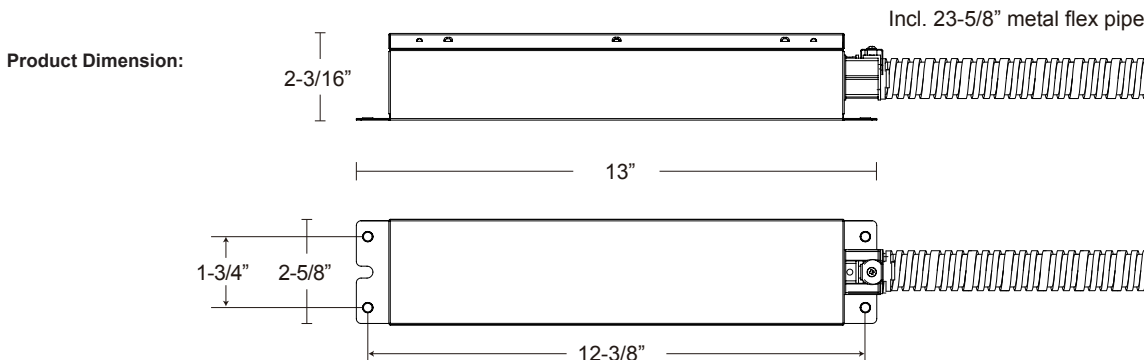

EMERGENCY LED INVERTER INSTALLATION GUIDE

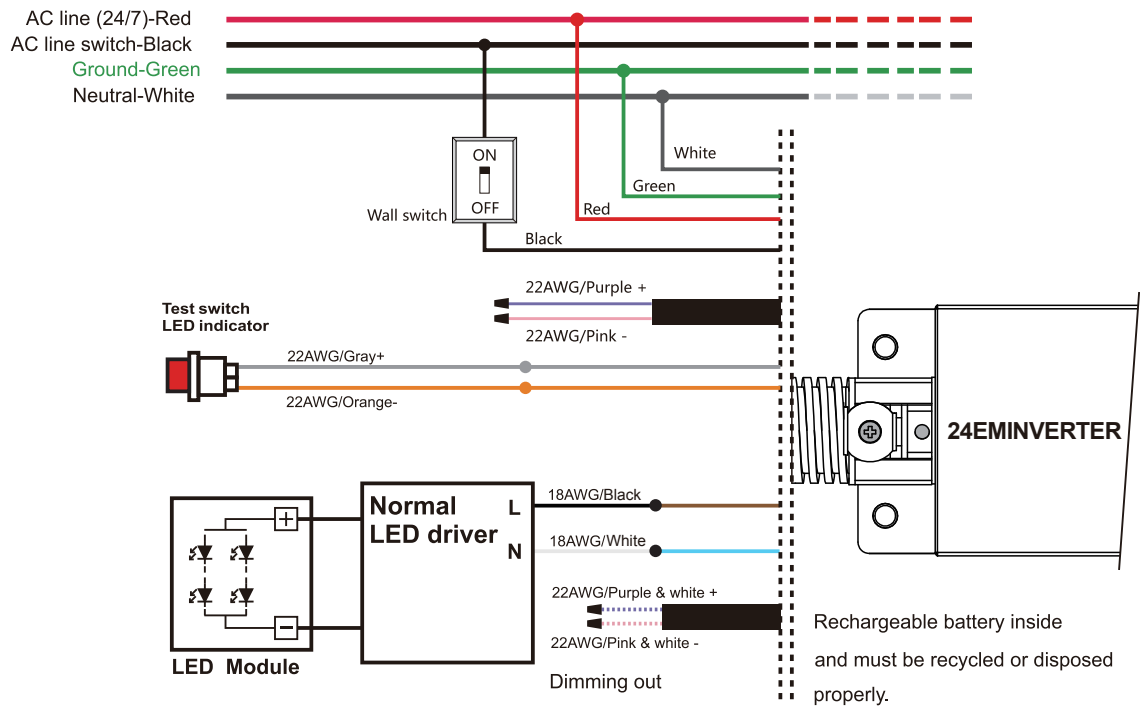

Cap off 0-10V wires for fixtures without dimming

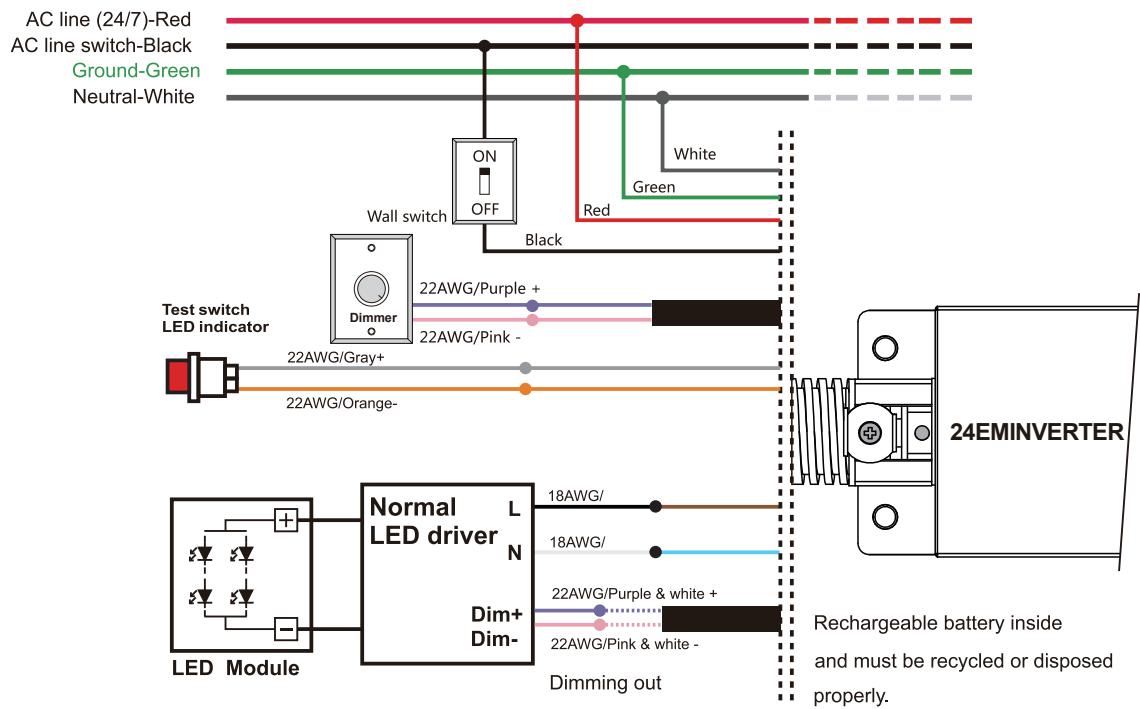

Fixtures with 0-10V dimming

TEST SWITCH & INDICATOR LIGHT

Part 2 - Accessories installation

Product Information:

SUPPLIED ACCESSORY		
Product	Model No.	Description
N.A.	EM Indicator	EM Inverter Indicator
OPTIONAL ACCESSORY ORDERING INFORMATION		
Product	Model No.	Description
37936	TAPETESTACC	EM Inverter Tape Indicator
37937	CEILTESTACC	EM Inverter Ceiling Mount Indicator
37938	WALLPLATE	EM Inverter Indicator Wall Mount Plate

Indicator Light:

Red On: Charging / Fully Charged

Off: Emergency Mode / Open Circuit / LED Load Exceeds Nominal Emergency Power

2-Second Slow Flashing: Requires Charging / Compatibility Test Standby Mode , if slow flashing after charged (in 24hrs) that means it's not compatible with fixtures

0.5-Second Fast Flashing: represents failure, not connected with power or load, need to check the wire

EM Inverter Indicator (Default Provided)

1. Pre-open a 1/2 " hole on the fixture housing and fix the test button on the fixture housing (Figure 1-1).
2. Wire the test button to EM inverter Indicator & Test button wires (Figure 1-2).



Figure 1-1

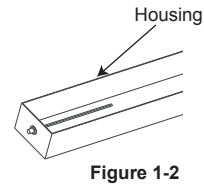

Figure 1-2

37938 WALLPLATE - EM Inverter Indicator Wall Mount Plate (Optional)

1. Assemble the indicator to the EM Inverter Indicator Wall Mount Plate (Figure 2-1).
2. Connect the indicator wire to the inverter within the junction box (provided by others).
3. Fix the plate on the junction box with 2 screws(Figure 2-2).

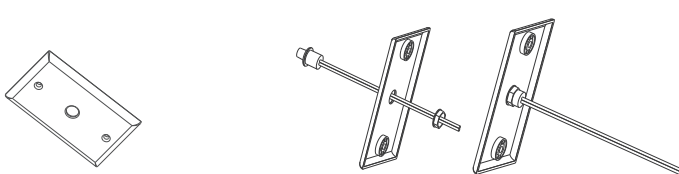

Figure 2-1

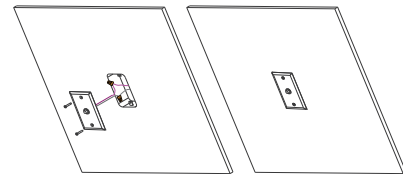

Figure 2-2

TEST SWITCH & INDICATOR LIGHT

37937 CEILTESTACC - EM Inverter Ceiling Mount Indicator (Optional)

1. Unplug the quick connector of the EM Inverter Ceiling Mount Indicator (Figure 3-1).
2. Cut a hole on the ceiling with 2 -2 3/8" diameter, wire the indicator cord to the inverter within the junction box (provided by others) and plug in the quick connector (Figure 3-2).
3. Pinch the 2 springs upward and push in the ceiling hole and release the springs (Figure 3-3).

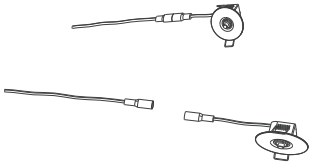

Figure 3-1

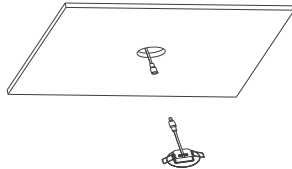

Figure 3-2

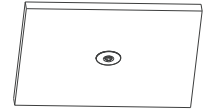
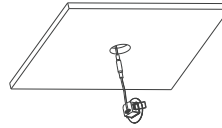

Figure 3-3

37936 TAPETESTACC - EM Inverter Tape Indicator (Optional)

1. Unplug the quick connector of the EM Inverter Tape Indicator (Figure 4-1).
2. Attach the test indicator to the fixture surface using the self-contained double-sided sticker (Figure 4-2).
3. Wire the indicator cord to the inverter within the junction box (provided by others).
4. Plug in the quick connector and follow the regular fixture installation instructions to complete the installation (Figure 4-3).

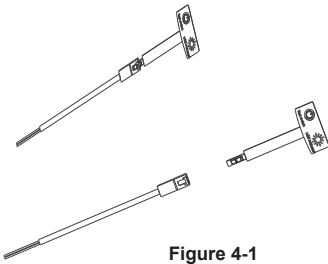

Figure 4-1

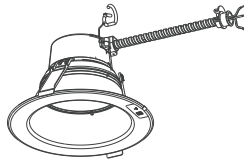

Figure 4-2

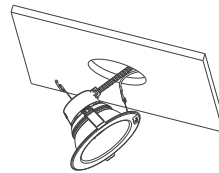
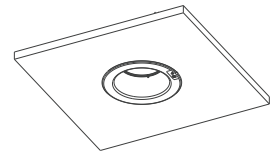

Figure 4-3



Test switch:

The Emergency Conversion Kit will enter emergency mode if the test switch is pressed while the main power supply is on. It will enter charging mode if the test switch is not pressed. In emergency mode, press the test switch for 3 seconds to exit the emergency state.

Protections:

- Input over current protection (fuse).
- Output over voltage protection.
- Output under current protection.
- Output short circuit protection.

Please note that this emergency inverter can only be used with GREEN CREATIVE or ILP products listed in the compatibility list.