



# FHSCP-UNV-10W-C-SD

## Emergency LED Driver

- Universal Voltage: 120-277V~
- Output Voltage Range: 15-55V =
- Output Current: 181-666mA
- Output Wattage: 10W
- Output Type: LED Class 2
- Number of Output Channels: 1 Channel
- Dry and Damp

### General Specifications

Input Voltage / Frequency	120-277V~, 50/60Hz
Input Current	0.1A Max
Input Power	5W Typical
Maintain Power	<0.85W
Input Power Pass-Through Rating (AC Driver Line)	5A
Max Output Rating (LED+ LED-Terminal)	3A Max
	55V Max
Output Power	10W
Output Voltage Range	15-55V =
Output Current Rated	181-666mA
Number of Output Channels	1Channel
Test Switch	Bi-Color Wet Location Test Switch (FHS-TSTWL-BC)
Input Surge Protection	3KV/6KV Ring Wave, 1KV/2KV Combine surge
Protections	Output Open Protection Output Overload Protection Output Short Circuit Protection
RFI/EMI	FCC Part 15A
Ambient Operating Temperature Rang	0°C To 55°C (32°F To 131°F)
Tc	62°C (143. 6°F)
Sound Rating	A
Battery Type	Lithium-ion
Battery Voltage	10.95V
Pack Capacity	2600mAh
Battery Rating	28.47Wh
Battery Count	3 Cells
Battery Recharge Time	24 Hours
Battery Discharge Time	Min 1.5 Hours
IP Rating	IP20
Test Switch Remote Mounting Distance	20' (6m) Max.
Service Life	50,000 hours @62°C (143. 6°F)
Warranty	@62°C (143. 6°F) 5 Years From the date of manufacture when properly installed
Safety Standard	UL 924, UL 1310, CSA C22.2 No.141



# FHSCP-UNV-10W-C-SD

## Mechanical Data

Overall Dimensions	
Length	5" [127mm]
Width	3.74" [95mm]
Height	1.181" [30mm]

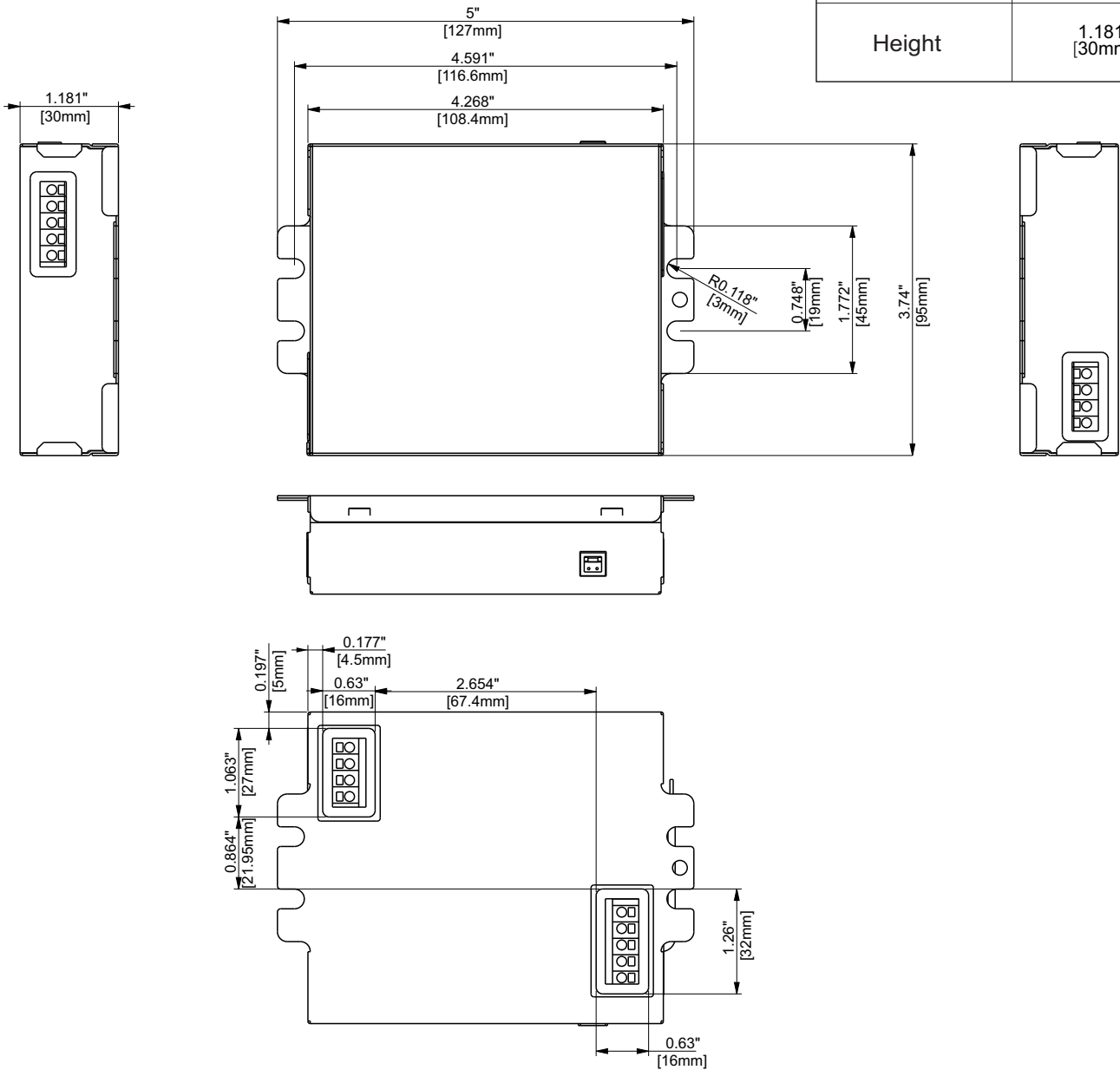

# FHSCP-UNV-10W-C-SD



## Accessories

Test switch wire: FHS-TST-BC

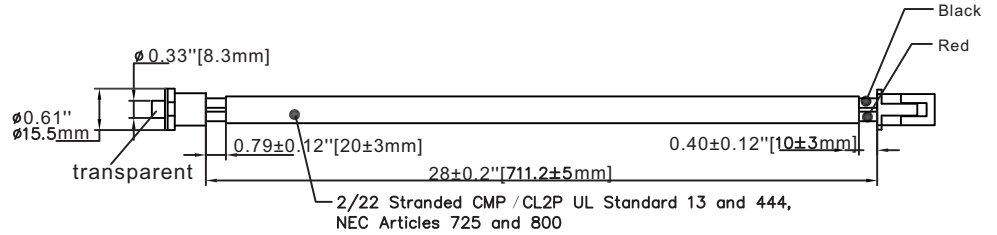

## Optional Accessories

Bi-Color Wet Location Test Switch: FHS-TSTWL-BC

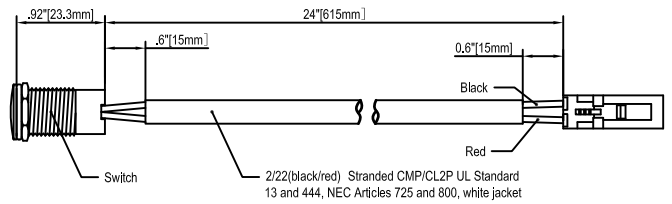

### Overall Switch Dimension

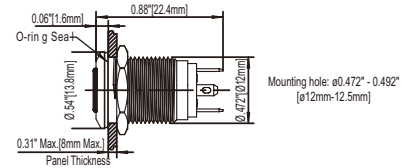
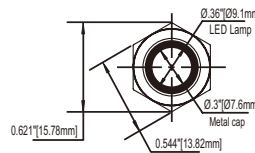



## Optional Accessories

Wall Plate: FHSWLPWH



Wall plate and screw color:  
white with black lettering

Wall Plate: FHSWLPPWH (Pure White Wall Plate)

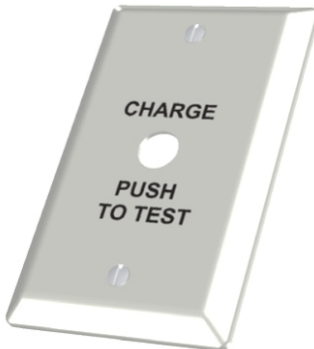

Wall plate and screw color:  
Pure white with black lettering

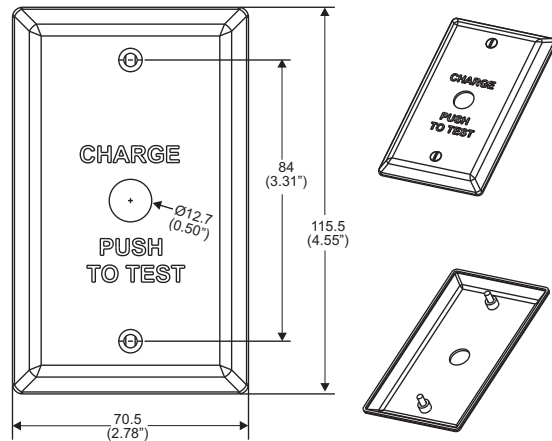

1. "Charge push to Test" plate
2. (2) 6-32 x 1/2" LG mounting screws



# FHSCP-UNV-10W-C-SD

## Wiring Diagram

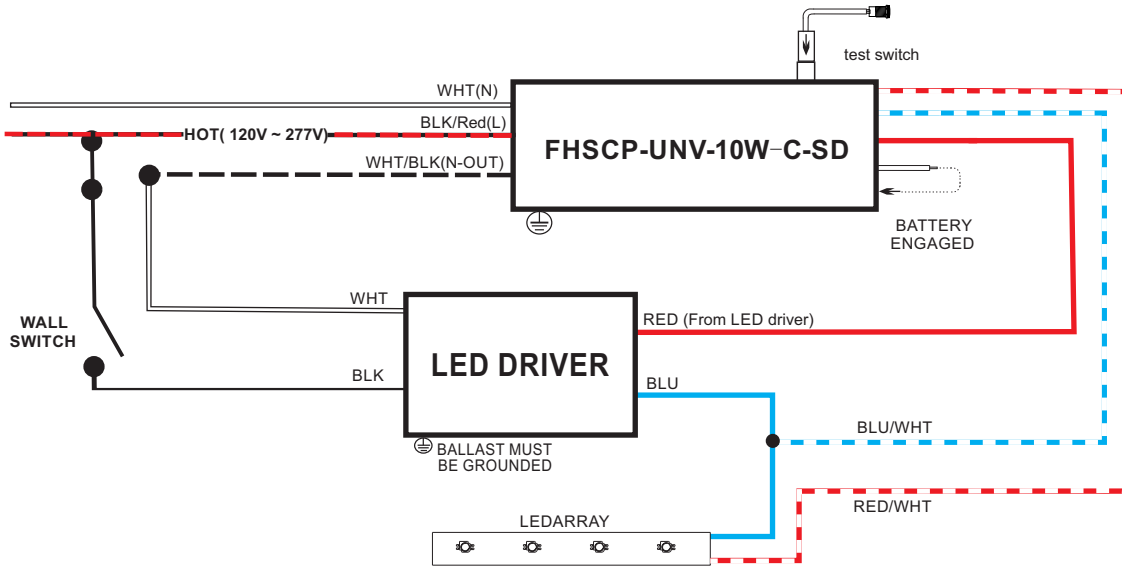

## Wiring Diagram (Emergency Only)

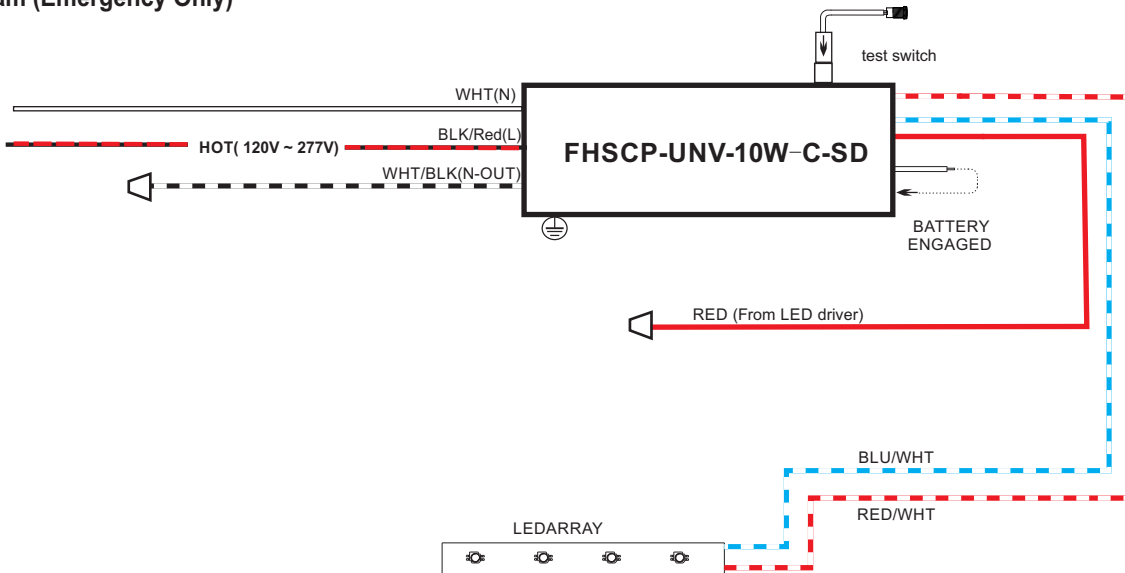



# FHSCP-UNV-10W-C-SD

## SELF-DIAGNOSTIC INSTRUCTIONS / OPERATION:

### If the self-diagnostic feature is enabled:











The emergency LED driver will conduct a self-check for sixty(60) seconds every thirty(30) days; and a ninety(90) minutes self-check every 12 months. After every self-check the LED indicator light will indicate a status signal. Check indicator status chart below to diagnose the status signal.

### If the self-diagnostic feature is disabled:

User must conduct a manual test every thirty (30) days to ensure the emergency LED light source illuminates as intended. A full discharge test shall be conducted once a year; the LED light source shall illuminate for a minimum of ninety (90) minutes.

**\*Self-Diagnostic feature is factory enabled**

## TEST SWITCH INDICATOR STATUS:

LED Indicators Status	EM Driver Status / Mode
 Solid Green	System OK / AC OK (Self-Diagnostic Enabled or Disabled)
 Slow Flashing Red, 4s on / 1s off	Battery NOT detected, check battery switch or connection
 Flashing Red, 1s on / 1s off	Battery Failure, replace battery
 Flashing Green, 1s on / 1s off	Self-Diagnostic test underway
 Slow Flashing Green, 0.1s on / 3s off	Normal working in EM mode
 Solid Red	No load or output over voltage protection triggered , Check LED connection
 Solid Red	Over Current Protection
 Flashing Green, 2s on/0.5s off	Enables Self-diagnosis
 Flashing Green, 0.5s on/2s off	Cancel Self-diagnosis
 Flashing Red, 0.5s on/3s off	Abnormal Power-on Under Self-diagnosis/Battery Voltage abnormal

### EM Test:

Press and hold the test button (>1s) to enter EM mode in normal AC powered.

### Manual Self-Diagnostic:

After charging twelve (12) hours at least, quickly press the test button three(3) times to force the controller to enter Self-Diagnostic cycle. To quit the Self-Diagnostic cycle after engaged, press and hold the test button for three (3) seconds.

### Query Self-Diagnostic Status:

Fast click 2 times within 2s to query the Self-Diagnostic status. The indicator would blink for current status for 3 cycles. 2s ON/0.5s OFF stands for Enabled. 0.5s ON/2s OFF stands for Disabled.

### How to Enable and Disable Self-Diagnostic Status:

Press and hold the test button for one second, then release, and press and hold the test button for 2 seconds.

### Cancel reporting error:

In standby, press and hold the button for about 5s to cancel the error indication.

### Emergency Battery Disconnect:

Press and hold the test switch for 5seconds during EM output condition to turn off EM output. This is useful for production environment to turn off the EM output once a luminaire has completed functionality testing.



# FHSCP-UNV-10W-C-SD

---

## Guidelines

### Grounding

- Driver must be grounded by means of the Driver case.

---

### LED load

- Fulham's Hotspot Constant Power Emergency LED drivers passive LEDs, -COB's and -LED assemblies Proper function is not guaranteed when (LED) loads with active components are used.

---

### Mounting / Cooling

- Above an output power of 10W, the driver needs to be mounted on a heat conductive surface of at least 200cm<sup>2</sup>. Always test if the surface is sufficient enough before installing the driver.

---

### Short-circuit protection

- In case of a short circuit the LED driver switches to protection mode. After the removal of the short-circuit the LED driver will recover automatically.

---

### No-load Operation

- In no-load operation the output voltage will not exceed the specified open circuit output voltage.

---

### Hot Swapping

- This driver does not support hot swapping of the LEDs

---

### Remote Mounting

- Up to 20ft with 18AWG. Contact Fulham for higher remote distance.

---

### Battery Maintenance

- In order to maintain proper operation and warranty coverage, the battery must be recharged once per year prior to installation.

---

### Warranty

- Reference Fulham's limited Warranty: <https://cdn.fulham.com/PDFs/Limited-Warranty.pdf>



# FHSCP-UNV-10W-C-SD

## Part Number Matrix

**FHS**

LED Driver

FHS = Fire Horse EM Driver

**CP**

Output Type

CP= Constant Power

**UNV**

Input Voltage

UNV= 120V-277V

**10W**

Power

10W= 10W

**C**

Characteristic

C= Compact

**SD**

Special Features

SD= Self Diagnostic

## Product Image: LED Driver

### FHSCP-UNV-10W-C-SD



## Packaging

### Master Carton

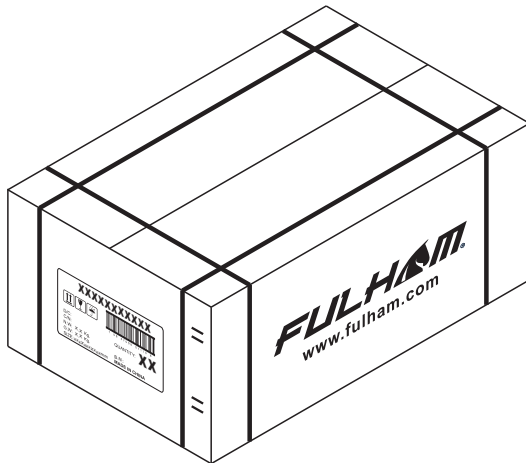

OUTER DIMENSION		
L	W	H
15.71" (399mm)	13.35" (339mm)	11.73" (298mm)
Net Weight	Gross Weight	QUANTITY
19.40lbs. (8.8kg.)	22.93lbs. (10.4kg)	20pcs.