

LED HI-PRO SHOP LIGHT



Models: 65/960, 65/961, 65/962, 65/963, 65/964, 65/965,
65/970, 65/971, 96/972, 65/973, 65/974, 65/975, 65/956, 65/957, 65/959

INSTALLATION AND SAFETY INSTRUCTIONS

IMPORTANT: Read before installing fixture. Retain for future reference.

WARNING: Risk of Fire or Electric Shock

- To avoid damage, falling, electric shock or fire, do not modify the lamp or replace accessories without confirming with the supplier first.
- Only authorized, qualified personnel should install this fixture and should follow the owner's manual. Any improper installation might cause failure, electric shock, fire or other injury, damage or hazard.
- Disconnect power before installation or any maintenance of the fixture.
- Do not dismantle the fixture without the supplier's authorization.
- Do not touch the power supply when the fixture is operating.
- The external flexible cable or cord of this fixture cannot be replaced; if the cord is damaged, the fixture shall be destroyed.
- Terminal block not included. The electrical fitting must be installed by a licensed electrician.
- For use in environments where an accumulation of non-conductive dust on the fixture may be expected.

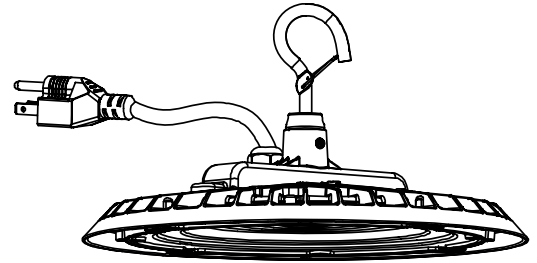

IMPORTANT: This product must be installed in accordance with the applicable installation code by a person familiar with the construction and operation of the product and the hazards involved. This product is suitable for 120V only.

WIRING DIAGRAM & INSTRUCTIONS

This product is suitable for both plug in and hardwire applications. For hardwired applications, cut plug and strip back the SVT to access the leads. Make sure power is off and connect the black wire to the AC Line, the white to the AC Neutral and the green to the ground. Make sure all connections are capped and sealed. Turn power back on.

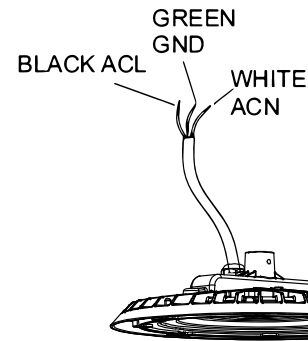
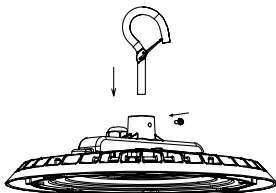

Figure1

INSTALLATION: Hook Mount

STEP 1: Screw the hook into the fixture, tighten and secure.



STEP 2: Hang the fixture on the ceiling hook or chain.

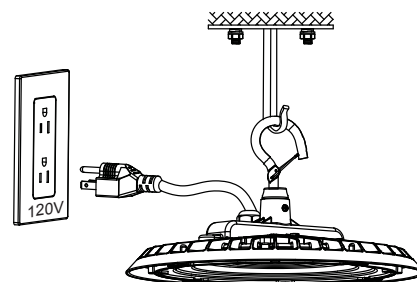

STEP 3: Connect wires using the wiring diagram and instructions on figure 1. Make sure connections are capped and sealed.



Satco Products, Inc.
Brentwood, NY 11717

LED HI-PRO SHOP LIGHT



Models: 65/960, 65/961, 65/962, 65/963, 65/964, 65/965,
65/970, 65/971, 96/972, 65/973, 65/974, 65/975

INSTALLATION AND SAFETY INSTRUCTIONS

IMPORTANT: Read before installing fixture. Retain for future reference.

INSTALLATION: Ceiling Mount

STEP 1: Use a pen or sharp tool and mark holes through the mounting surface on the ceiling and drill holes. Fix screws into the holes with a hammer.

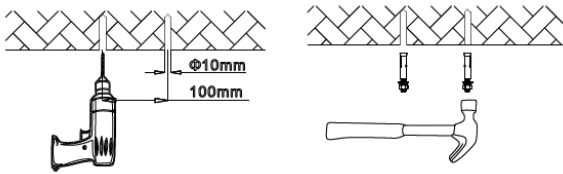

STEP 2: Align the bracket hole with screw hole and push the fixture to one side and secure.

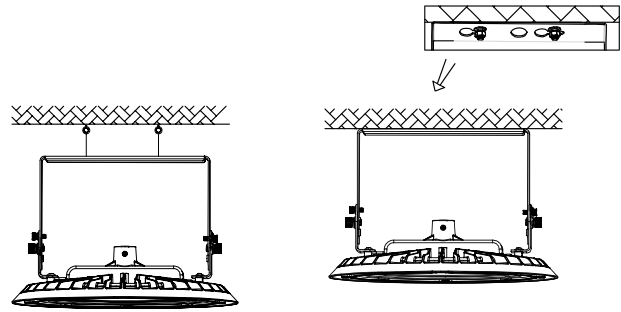

STEP 3: Plug fixture into outlet or for hardwired applications follow instructions on page 1. Make sure connections are capped and sealed.

NOTE: By adjusting the bracket screws, the fixture can be angled 50° to the left or right vertically.

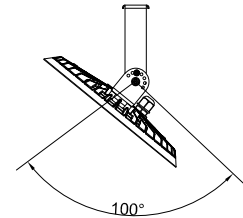

Additional Accessories:

Wire Guard Installation:

To attach the wire guard, use the provided screws to attach to the pre-tapped holes on the face of the fixture.

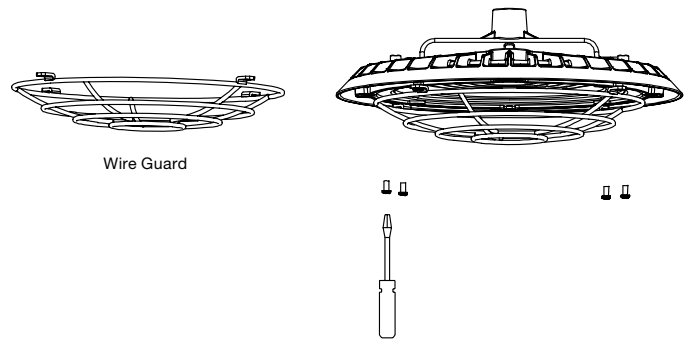

Suspension Kit Installation:

To attach the suspension kit, use the provided screws to attach to the pre-tapped holes on the back of the fixture.

