



IHCV-1M1UNV012V-60L

IP65



RoHS COMPLIANT

CE

FC

UL LISTED E342838

Constant Voltage LED Driver

- Input Voltage: 110V - 277V, 50/60Hz
- Output Current: 5.0A Max.
- Output Voltage: 12V $\overline{\text{DC}}$
- Output Power: 60W Max.
- Class 2 LED Driver
- Isolated 0-10V Dimming
- Suitable for Dry and Damp location
- Class P

General Specifications

Input Voltage / Frequency	110V - 277VAC 50/60Hz
Input Current	0.7A Max.
Input Power	78W Max.
Input Power Factor	>0.90 @60-100% load @ Input 277V
THD	<20% @60-100% load @ Input 277V
Driver Type	Constant Voltage
Output Voltage Range	12V $\overline{\text{DC}}$
Output Current	0-5000mA
Output Power	60W Max.
Efficiency	87%
Output Type	Constant Voltage
Inrush Current	52.8A @277VAC
Max. Leakage Current	0.75mA
Total Over All Ripple	<10%
Flicker Percentage	30%
Dimming Type	0-10V
Dimming Range	100% - 0.1%
Dimming isolation	Yes
Operating Ambient Temperature Range	-40°C - 52°C (-40°F To 125.6°F)
Max. Driver Case Temperature	90°C
Start Up Time	0.5s
Number of Output Channels	1
Overall Size	9.52"x 1.201"x 1.75"(241.8mm x 44.5mm x 30.5mm)
Weight	1.23 lbs (586g)
Wire Type / Length	Input: 18AWG / 11.8"(300mm) Output & Dimming: 18AWG / 11.8"(300mm)
Safety / Compliance	cULus Listed, UL 8750, UL1310 CSA C22.2 No.250.13, IEC/EN 61347-1, IEC/EN 61347-2-13 FCC Part 15B@110VAC, FCC Part 15A@277VAC, EN IEC 55015 EN IEC 61000-3-2, IEC/EN 61000-3-3, IEC/EN 61547
IP Rating	IP65
Operating Humidity	5-95% RH Non-condensing
Input Surge Protection	2kV Combination Wave, RingWave 2.5kV
Protections	Over-Voltage Protection, Over-Current Protection, Over-Power Protection Short-Circuit Protection, Over-Temperature Protection
Sound Rating	A
Service Life	50,000Hrs @Max Load, 80°C Tc
Warranty	5 years @ Tc 80°C from the date of manufacture

General Wiring Diagram

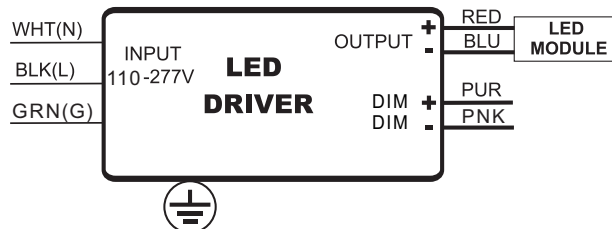



IHCV-1M1UNV012V-60L

Typical Characteristics Curve

IP65



RoHS COMPLIANT



Figure 1

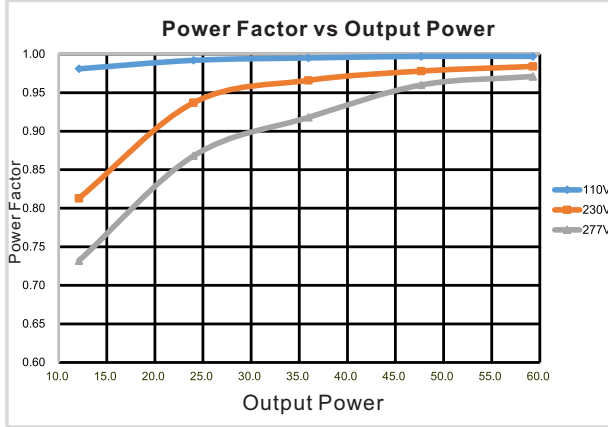

Figure 2

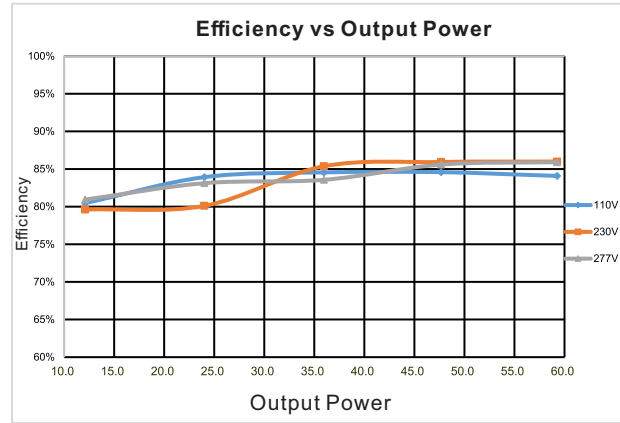

Figure 3

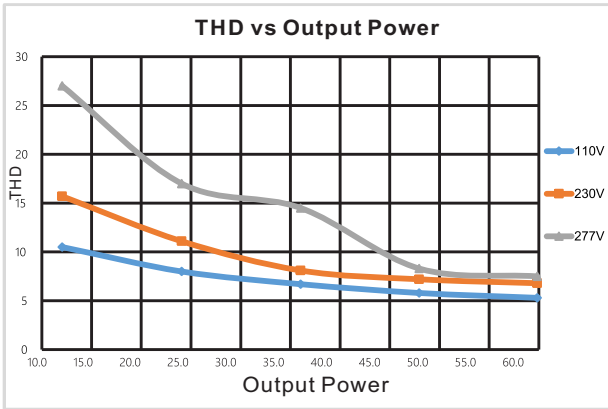

Figure 4

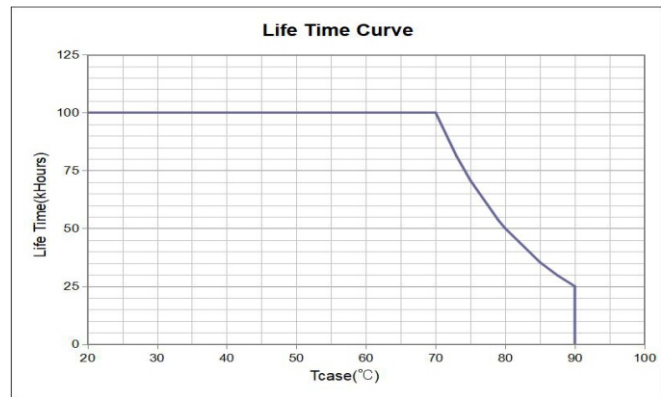

Figure 5

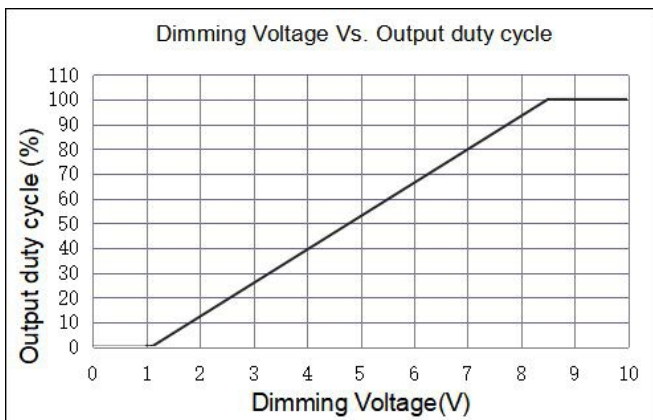
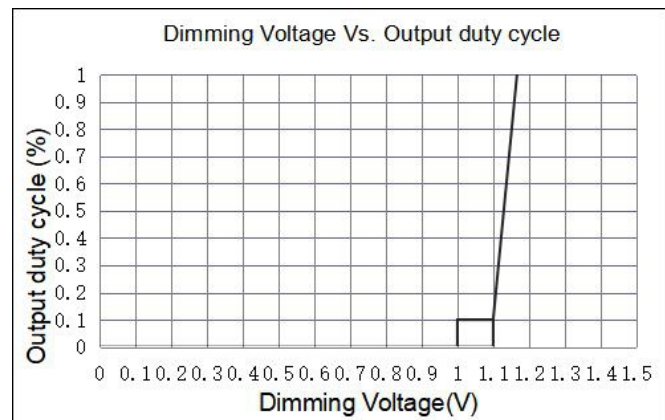

Figure 6





IHCV-1M1UNV012V-60L

IP65



RoHS COMPLIANT



Part Number Matrix

IH CV 1 M 1 UNV 012 V 60 L

LED Driver	Constant Voltage	# of Control Channels	Control Type	# of Output Channels	Input Voltage	Output Voltage	Characteristic	Max. Output Power	Case Type
IH=IceHorse	CV = Constant Voltage	1 = 1 Channel	M = 0-10V dimming	1 = 1 Channel	UNV=120-277V	012=12V	V = Voltage	60=60W	L = Linear

Mechanical Drawings

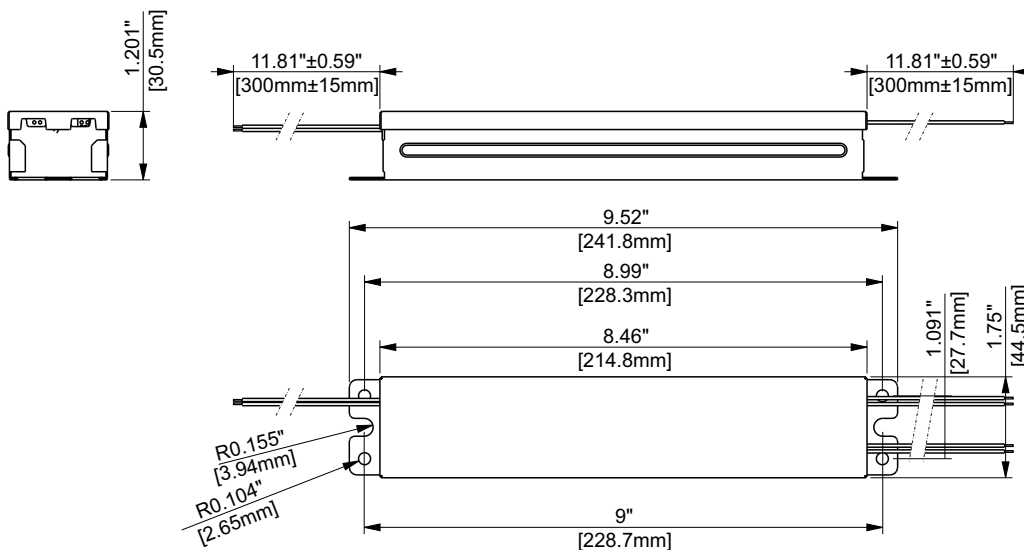

Overall Dimensions	
Length	9.52"(241.8mm)
Width	1.75"(44.5mm)
Height	1.201"(30.5mm)

Wire Length	
Input	11.8"(300mm)
Output	11.8"(300mm)



IHCV-1M1UNV012V-60L

IP65



RoHS COMPLIANT



Product Image:



Packaging

Master Carton

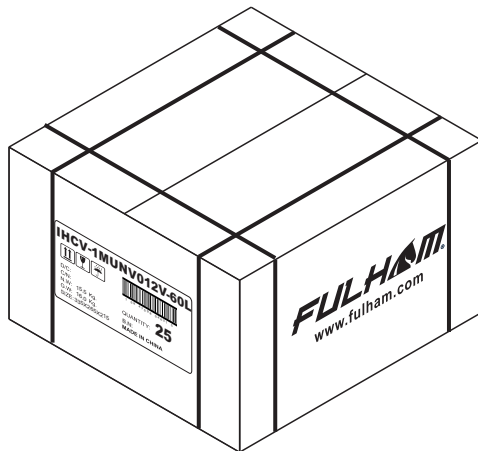

OUTER DIMENSION		
L	W	H
13.19" (335mm)	10.43"(265mm)	8.46" (215mm)
Net Weight	Gross Weight	QUANTITY
34.17bs. (15.5kg.)	35.27lbs. (16.0kg)	25pcs.