



PLT-13241 - 40/60/80W - Up to 11,354 Lumens, 30/40/50K, Bronze Finish

- Photocell

Wattage	CCT	Lumens	LPW
40	3000K	5,434	136
	4000K	5,547	139
	5000K	5,605	140
60	3000K	7,829	130
	4000K	8,026	134
	5000K	7,959	133
80	3000K	10,671	133
	4000K	11,354	142
	5000K	11,140	139



DIMENSIONS

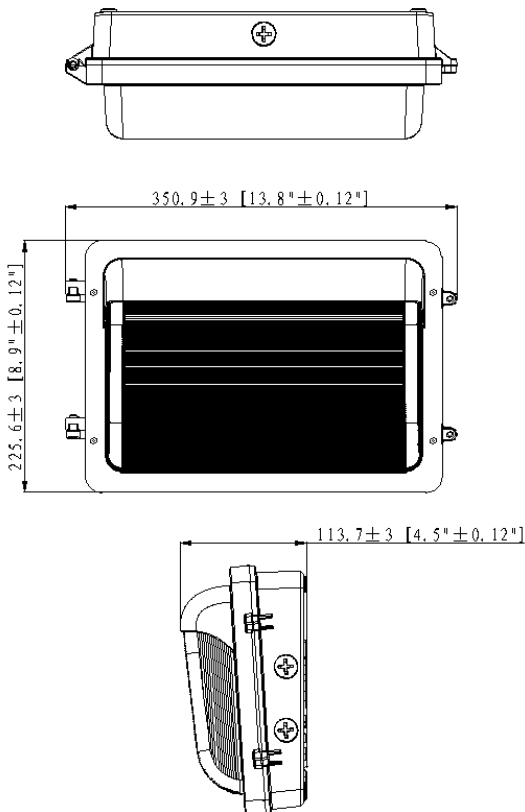

ADVANTAGE

- UL
- Lumileds 2835.
- Input voltage 120-277VAC .
- Dimmable with 0-10V dimmers
- No UV or IR in the beam.
- Easy to install and operate.
- Energy saving, long lifespan.
- Light is soft and uniform.
- Instant start, NO flickering, NO humming.
- Green and eco-friendly without mercury.

APPLICATION

- Entrance lighting, courtyard lighting;
- Industrial lighting, Outdoor landscape lighting;
- Hotels and other commercial applications

SPECIFICATIONS

OPTICAL	Input Power (Tolerance : ±10%)	80/60/40W		
	Color Temperature(Color tunable)	3000K	4000K	5000K
	Lumen (Tolerance : ±10%)	10,671 LM	11,354 LM	11,140 LM
	Efficacy (Tolerance : ±3%)	133 LM/W	142 LM/W	139 LM/W
	CRI	>80		
	Color Consistency	<7 Steps (or <7 SDCM)		
	BUG	B1-U3-G4		
	Diffuser Type	Glass		
	Beam Angle (50%) (Tolerance : ±15%)	H87*V67 Degree		
ELECTRICAL	Input Voltage and Frequency	120-277VAC 50/60Hz		
	PF (Tolerance : -3%)	≥0.9		
	THD (Tolerance : +5%)	≤20%		
	Flicker Percent	<30%		
	Driver Brand	Becky		
	Driver Model	BQE80C-130-PVF-PS / BQE80C-130-PVF-PSA		
	Driver Surge protection	L-N: 10kV , L&N-E:10kV		
	Dimming	0-10V dimming standard		
	Sensor Type	Photocell, Occupancy Sensor*		
	Optional Accessory	Surge-protective Device*, Motion Sensor*, PIR Sensor*		
MATERIALS	LED Brand	LUMILEDS		
	LED Type	SMD 2835		
	LED QTY	240*2PCS		
	Housing	Die-cast aluminum		
	Housing Color	Bronze, other colors*		
	Waterproof Rating	WET (IP65)		
OTHERS	Operating Temperature	-40°C TO 45°C, Sensor :-25°C TO 45°C		
	Storage Temperature	-40°C TO 80°C		
	Operating Humidity	20% - 90% RH		
	Storage Humidity	10% - 95% RH		
	Warranty	5 years warranty		

*Additional accessories and color options available via Special Order. Please call 1-800-624-4488.

PCKAGE

	Size	Qty / Carton	Net Weight / Carton	Gross Weight / Carton
Outer box	383*270*165MM (15"*10.6"*6.5")	1 PCS	3.3KG (7.3lb)	4.2KG (9.3lb)

Tolerance of Carton Size: ±15 MM (±0.6"), Tolerance of Weight: ±10%.

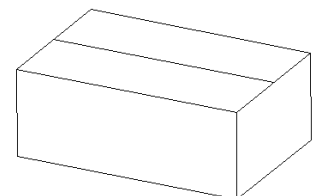
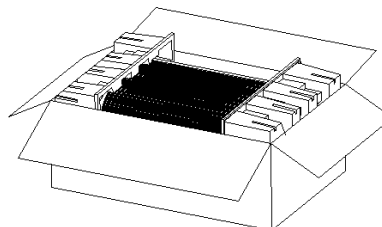
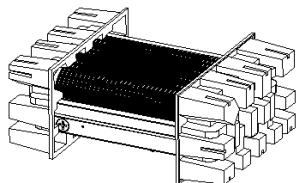
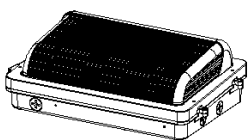

LIGHT DISTRIBUTION TESTING PARAMETERS

Luminaire Property

Luminaire Manufacturer:
 Luminaire Category:
 Lamp Catalog:
 Number of Lamps:
 Luminous Length (mm):
 Luminous Height (mm):
 Current: 0.658 A
 Power Factor: 0.991

Luminaire Description:
 Lamp Description:
 Lumens per Lamp:
 Luminous Width (mm):
 Voltage: 120.0 V
 Power: 78.25 W

Photometric Results

IES Classification: Type IV
 Total Rated Lamp Lumens: 10124.3 lm
 Efficiency: 100%
 Upward Ratio: 7%
 C0r0 Intensity: 2273.25 cd
 Pos of Max. Intensity: H90 V40
 Beam Angle(C0/C180,C90/C270,C45/C225,C135/315): 126.8, 76.0, 73.7, 73.3

Longitudinal Classification: Very Short
 Measurement Flux: 10124.3 lm
 Downward Ratio: 93%
 Luminaire Efficacy Rating (LER): 129.43
 Max. Intensity: 5814.89 cd

Luminous Intensity Distribution Curve

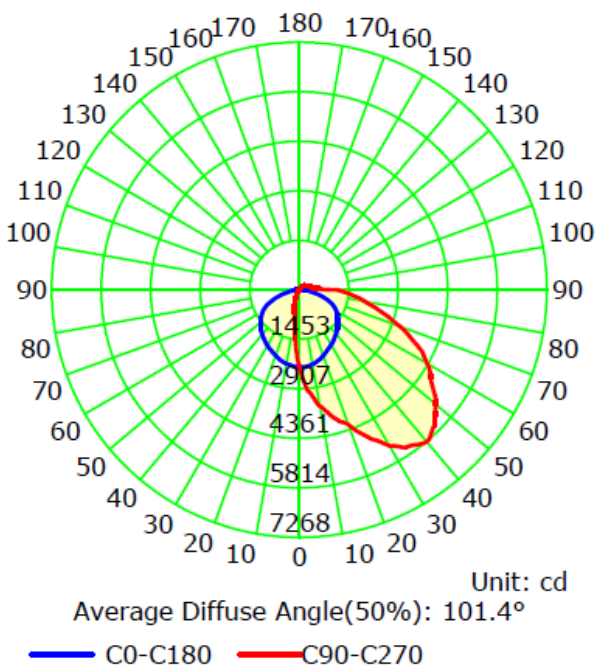

The Average Illuminance Effective Figure

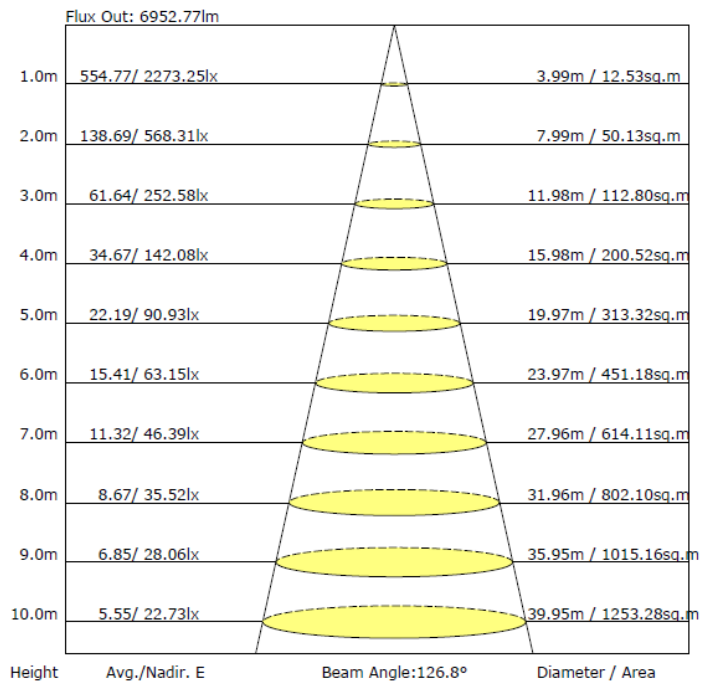

NOTICE FOR USER

- Please turn off power before installation or maintenance.
- Verify that supply voltage is correct by comparing it with the luminaire label information. Please make sure the wiring is insulated.
- Installation, service, and maintenance of luminaires should be performed by a qualified licensed electrician.

TROUBLESHOOTING

Problem	Solution
Flickering Light	Turn off the power, then turn on again after 3 minutes. If the light continues to flicker, call a licensed electrician.
Fixture not turning on	Check the electrical connection.

Selectable CCT:

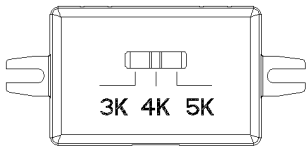

Color tunable instruction

- 1, The color temperature of the lamp turns to 3000K when the switch is set to 3K;
- 2, The color temperature of the lamp turns to 4000K when the switch is set to 4K;
- 3, The color temperature of the lamp turns to 5000K when the switch is set to 5K;

Note: Please turn off the power before adjusting the color temperature.