



PYCC-2U1UNV080S-40C

Selectable Constant Current LED Driver, 0-10V & Phase@120V Dimming

- Input Voltage: 120V - 277V, 50/60Hz
- Dimming Types: 0-10V & Phase@120V
- Dimming Range: 100% - 10%
- Class 2 LED Driver
- cULus Listed, Class P
- Isolated 0-10V from Input and Output
- Selectable Output Current: 650 / 700 / 750 / 800mA
- Output Voltage: 30-42VDC

General Specifications

Input Voltage / Frequency	120V - 277VAC 50/60Hz
Input Current	0.34A Max.
Input Power	42W Max.
Input Power Factor	>0.9
THD	<20%
Driver Type	Current Selectable
Output Voltage Range	30VDC - 42VDC
Selectable Output Current	650mA, 700mA, 750mA, 800mA (±7%) remark: 800±7% means at least 90% load, others (no specified range), the tolerance of lout is ±10%
Output Power	33.6W Max.
Efficiency@Full load	>84%@120VAC; >84%@277VAC
Output Type	Constant Current
Inrush Current	30A @277VAC
Max. Leakage Current	0.75mA
Total Over All Ripple	<30%
Flicker Percentage	<30%
Dimming Type	0-10V & Phase@120V (see dimmer list)
Dimming Range	100% - 10%
Dimming isolation	Yes
Storage Temperature Range	-40°F ~ 131°F (-40°C ~ 55°C)
Operating Ambient Temperature Range	-22°F ~ 104°F (-30°C ~ 40°C)
Max. Driver Case Temperature	194°F (90°C)
Start Up Time	0.7s @ Full load
Number of Output Channels	1
Overall Size	3.4"x 1.9"x 1.1" (86.4mm x 47.6"mm x 27.8mm)
Weight	0.40lbs (180g)
Wire Type / Length	Input: Black/White 18AWG 160mm/6.3" Output: Red/Blue 20AWG 150mm/ 5.9"; Dimming: Purple/Pink 22AWG 300mm/ 11.8"
Safety / Compliance	cULus Listed, Class P; LED Class 2 CAN/CSA-C22.2 No. 250.13 FCC Title 47 Part 15A
IP Rating	Dry and Damp locations, IP20
Operating Humidity	10-90% RH Non-condensing
Input Surge Protection	C62.41 RingWave 2.5kV
Protections	Over-Voltage Protection Short-Circuit Protection
Sound Rating	A
Service Life	50,000Hrs @Max Load, 75°C Tc
Warranty	5 years @ Tc 75°C from the date of manufacture

General Wiring Diagram

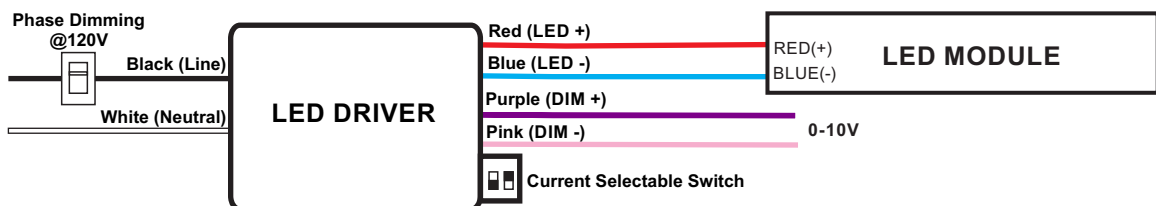

Note: 0-10V and Phase dimming should not use together.



PYCC-2U1UNV080S-40C

Output Current Adjustable

Switch 1	Switch 2	I _{out}
OFF	OFF	800mA
ON	OFF	750mA
OFF	ON	700mA
ON	ON	650mA

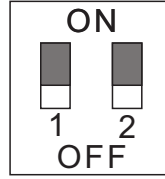

800mA



750mA

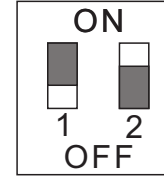

700mA

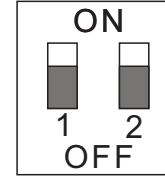

650mA

Typical Characteristics Curve

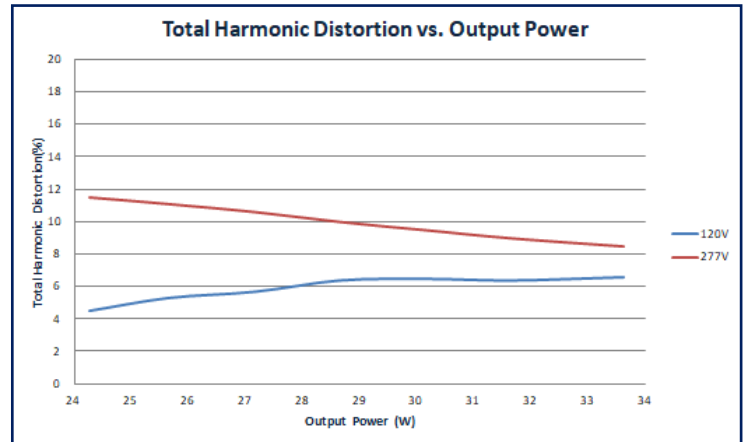
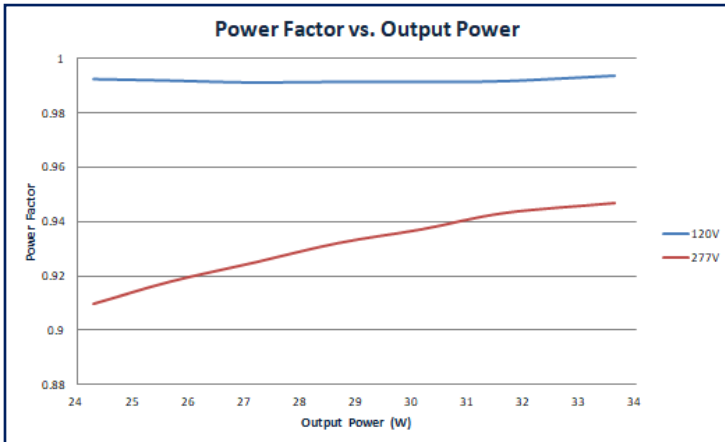
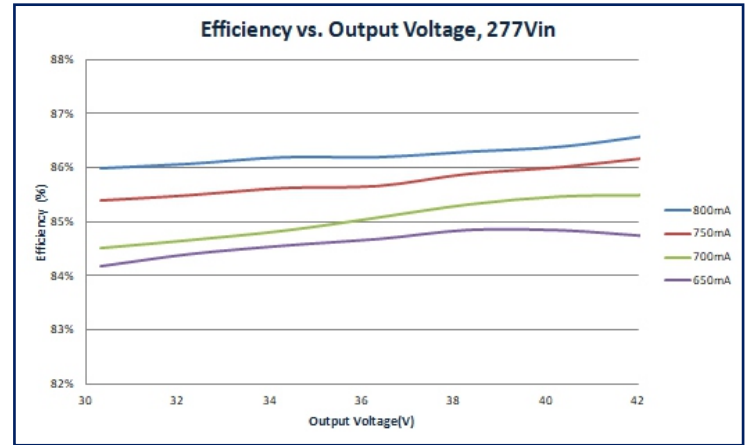
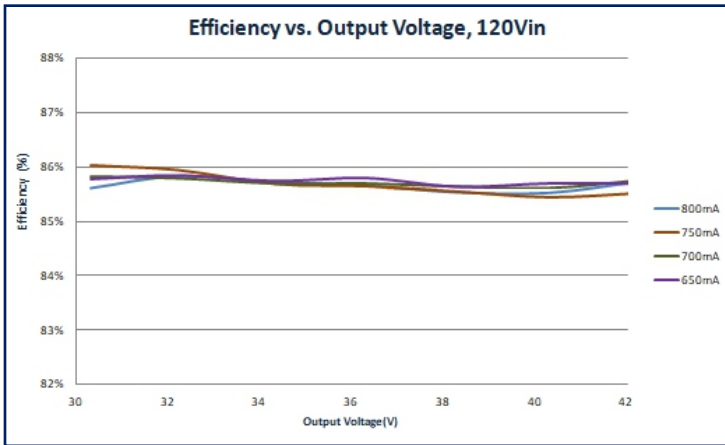



PYCC-2U1UNV080S-40C

Typical Characteristics Curve

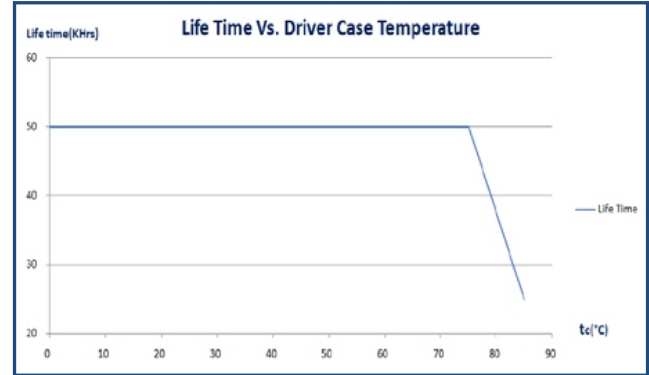
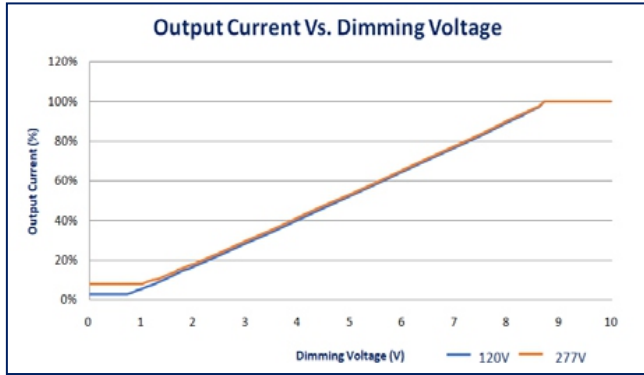

Compatible 120V Phase Dimmer List

Manufacturer	Part Number of Manufacturer	Type of Dimmer	Manufacturer	Part Number of Manufacturer	Type of Dimmer
LUTRON	SCL-153P	TRIAC			
LUTRON	DVCL-153P	TRIAC			
LUTRON	SELV-300P	ELV			
LUTRON	SELV-303P	ELV			
LUTRON	DVELV-300P	ELV			

Mechanical Drawings

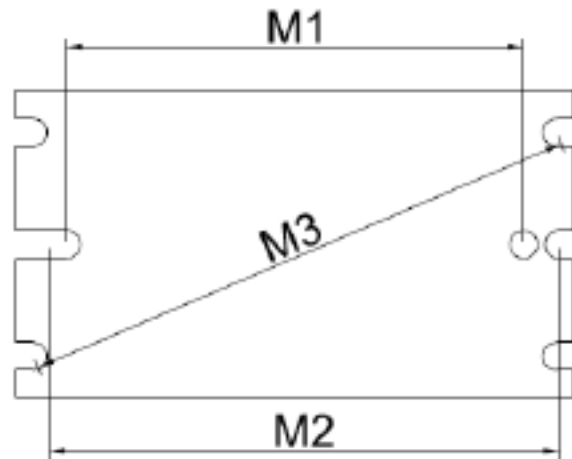
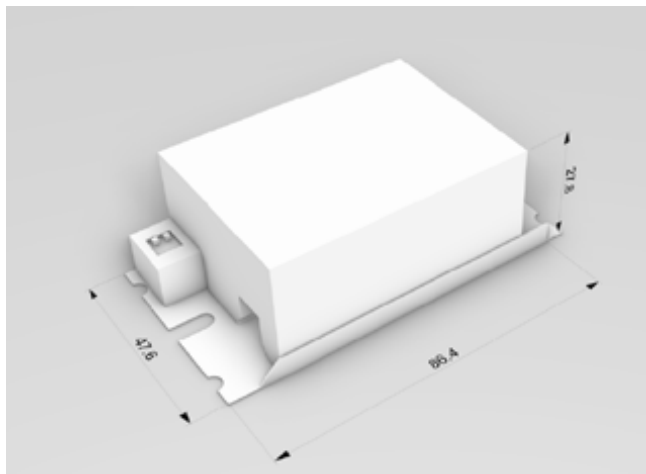

Overall Dimensions	
Length	3.4"(86.4mm)
Width	1.9"(47.6mm)
Height	1.1"(27.8mm)

Mounting Size	
M1	2.8"(70.9mm)
M2	3.24"(82.2mm)
M3	3.5"(88.2mm)

Wire Length	
AC Input	6.3"(160mm)
LED Output	5.9"(150mm)
0-10V Dim	11.8"(300mm)

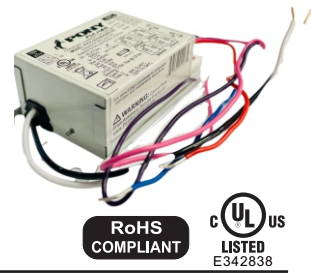

PYCC-2U1UNV080S-40C

Guidelines

Grounding

- Driver must be grounded by means of the Driver case.

Over temperature protection

- The Fulham Pony LED drivers are protected against thermal overload. If the temperature limit is exceeded, the output current is reduced.

LED load

- The Fulham Pony LED drivers are designed to drive passive LEDs, -COB's and -LED assemblies. Proper function is not guaranteed when (LED) loads with active components are used.

Short-circuit protection

- In case of a short circuit the LED driver switches to protection mode. After the removal of the short-circuit the LED driver will recover automatically.

No-load Operation

- In no-load operation the output voltage will not exceed the specified open circuit output voltage.

Hot Swapping

- This driver does not support hot swapping of the LEDs.

Remote Mounting

- Up to 26ft with 18AWG. Contact Fulham for higher remote distance.

Service life/Lifetime

- Failure Rate Info based upon MTBF modeling: 90% survivals at end of life @ $\leq T_c$ lifetime rating.

Warranty

- Reference Fulham's limited Warranty: <https://cdn.fulham.com/PDFs/Limited-Warranty.pdf>



PYCC-2U1UNV080S-40C

Part Number Matrix

PY CC 2 U 1 UNV 080S 40 C

LED Driver	Output Type	# of Control	Type Of Control	# of Output Channels	Input Voltage	Output Current	Max. Output Power	Case Type
PY = Pony LED	CC=Constant Current	2 = 2 Controls	U = 0-10V & Phase	1 = 1 Channel	UNV = 120V~277V	080S = 800/750/700/650mA Selectable	40 = 40W	C = Compact

Product Image

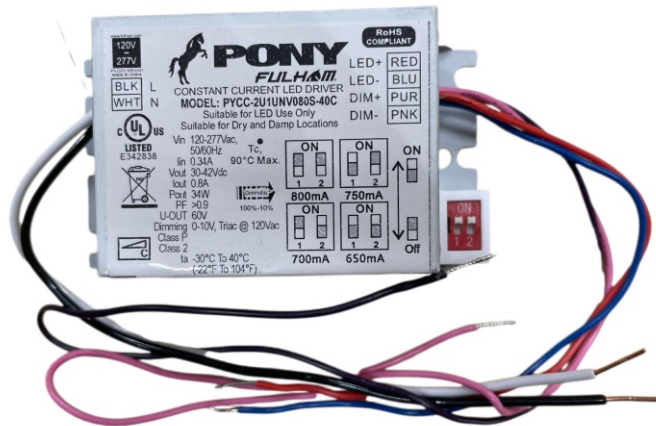

Packaging

Master Carton

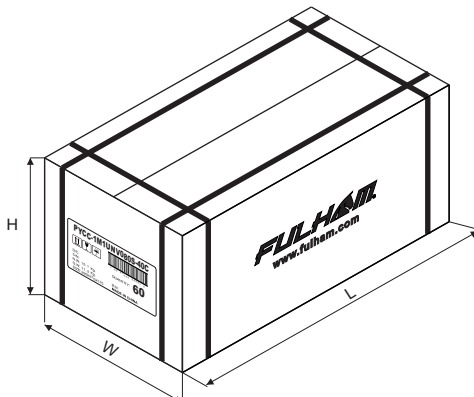

OUTER DIMENSION		
L	W	H
11.42"(290mm)	10.63"(270mm)	6.89"(175mm)
Net Weight	Gross Weight	QUANTITY
23.80lbs. (10.8 kg)	24.91lbs. (11.3 kg)	60pcs.