



### WARNING

- Installation, service, and maintenance of luminaires should be performed by a qualified licensed electrician.
- Read instructions carefully before starting installation.

### NOTICE

- Do not install the luminaire in a location where it will be exposed to harmful chemicals such as sulphur, acid, or halogen.

### Installation Instructions

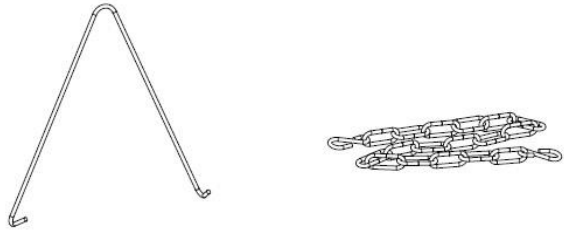
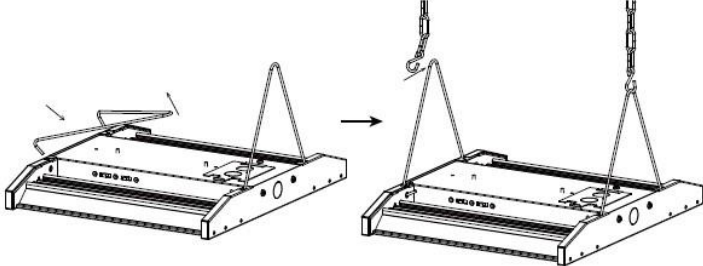
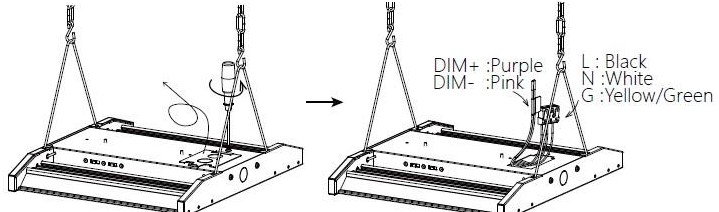
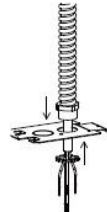
<p>Step 1. Open the package and take out the accessories.</p>	 <p>V-hook *2                      40inch Chain *2</p>
<p>Step 2. Install the V-hooks and chains to the fixture.</p>	
<p>Step 3. Unscrew the wiring back-plate from the housing, then take out the terminal block and dimming wires.</p>	 <p>DIM+ :Purple DIM- :Pink L : Black N :White G :Yellow/Green</p>
<p>Step 4. Feed the flexible conduit (not provided) through the wiring back-plate.</p>	 <p>Flexible conduit</p>



# LED HIGH BAY

## WARNING, CAUTION, SAFETY AND INSTALLATION INSTRUCTIONS

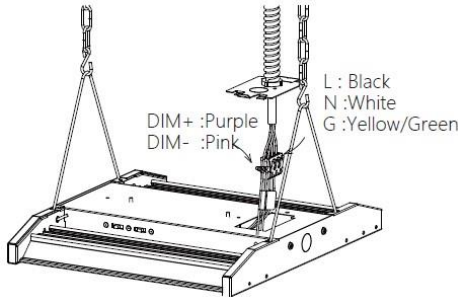
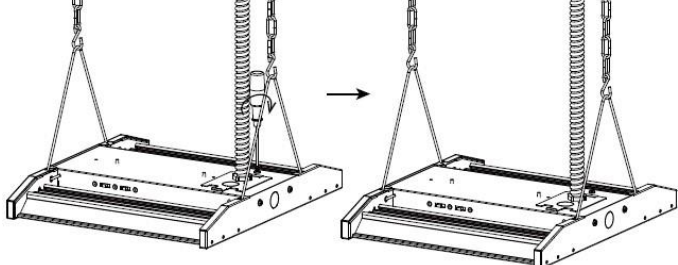
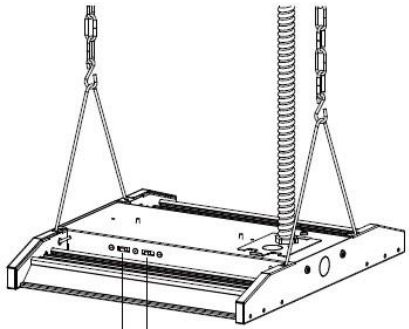
<p>Step 5. Wiring:</p> <ol style="list-style-type: none"> <li>Black=Line</li> <li>White=Neutral</li> <li>Yellow/Green=Ground</li> <li>Purple=Dim+</li> <li>Pink=Dim-</li> </ol> <p>***Purple and pink wires are for 0-10V dimming. Cap wires if dimming will not be used.</p>	 <p>L : Black N : White G : Yellow/Green DIM+ : Purple DIM- : Pink</p>
<p>Step 6. Make sure all wires are securely connected, then screw the wiring back-plate onto the fixture.</p>	
<p>Step 7. Select your desired wattage and CCT using the slider switches on the side of the LED driver box, then turn on the power to verify your successful installation.</p> <p>Default Settings:</p> <ul style="list-style-type: none"> <li>100W, 5000K</li> </ul>	 <p>CCT/Watt Selectable Switch</p>

### Wiring Diagram

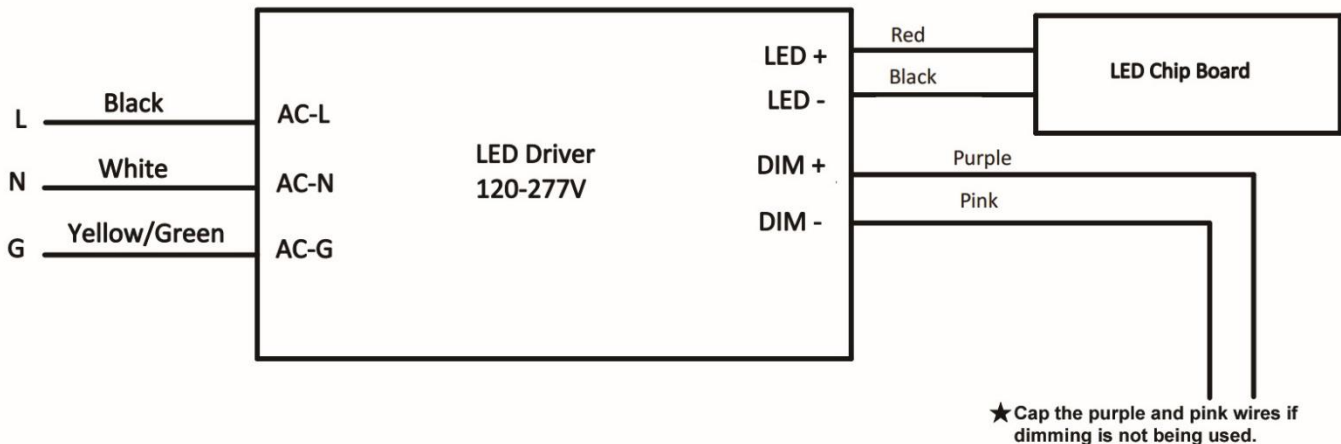

**⚠ WARNING**

- Before installing, servicing, or performing routine maintenance upon this equipment, follow these general precautions.
- To reduce the risk of death, personal injury, or property damage from fire, electric shock, falling parts, cuts/abrasions, and other hazards, read all warnings and instructions included with and on the fixture box and all fixture labels.
- Proper grounding is required to ensure safety.
- Power must be turned off at the breaker before installation or maintenance.
- This product must be installed in accordance with the applicable installation code by a person familiar with the construction and operation of the product and the hazards involved.
- Wear gloves and eye protection at all times while installing, servicing, or performing maintenance on the luminaire, and avoid direct eye exposure to the light source while it is on.
- To prevent wiring damage or abrasion, do not expose wiring to edges of sheet metal or other sharp objects.
- Do not install damaged product. Inspect luminaire for damage that may have occurred during transit. If damaged, contact the manufacturer immediately.
- These instructions do not purport to cover all details or variations in equipment nor to provide every possible contingency to meet in connection with installation, operation, or maintenance. Should further information be desired or should particular problems arise which are not covered sufficiently for the purchaser's or owner's purposes, contact the manufacturer.

**⚠ ADVERTENCIA**

- Antes de instalar, reparar o realizar el mantenimiento de rutina de este equipo, siga estas precauciones generales.
- Para reducir el riesgo de muerte, lesiones personales o daños a la propiedad por fuego, descarga eléctrica, caída de piezas, cortes / abrasiones y otros peligros, lea todas las advertencias y instrucciones incluidas con y en la caja del dispositivo y todas las etiquetas del dispositivo.
- Se requiere una conexión a tierra adecuada para garantizar la seguridad.
- Se debe apagar la energía en el disyuntor antes de la instalación o el mantenimiento.
- Este producto debe ser instalado de acuerdo con el código de instalación aplicable por una persona familiarizada con la construcción y operación del producto y los peligros involucrados.
- Utilice guantes y protección para los ojos en todo momento durante la instalación, el servicio o el mantenimiento de la luminaria, y evite la exposición directa de los ojos a la fuente de luz mientras está encendida.
- Para evitar daños o abrasiones en el cableado, no exponga el cableado a bordes de láminas de metal u otros objetos afilados.
- No instale un producto dañado. Inspeccione la luminaria en busca de daños que puedan haber ocurrido durante el tránsito. Si está dañado, comuníquese con el fabricante de inmediato.
- Estas instrucciones no pretenden cubrir todos los detalles o variaciones en el equipo ni proporcionar todas las posibles contingencias a cumplir en relación con la instalación, operación o mantenimiento. Si desea obtener más información o si surgen problemas particulares que no están suficientemente cubiertos para los propósitos del comprador o propietario, comuníquese con el fabricante.