



# HALFMOON LED WALL PACK

3 CCT & WATTAGE SELECTABLE

---



## APPLICATION

---

IP65 Rating Full Cutoff Halfmoon Wall Pack is widely used in wet locations like processing workshops, storage warehouses, steel mills, toll booth, waiting rooms, and railway stations.

## GENERAL FEATURES

---

- Wide range input voltage AC120-277V, 120-347V
- Sensor with receptacle available as optional accessory\*
- EM backup available as optional accessory\*
- Built-in DC photocell
- Die-cast aluminum housing, high quality and good for heat dissipation
- 0-10V dimming
- IP65 Rating
- 5 Years warranty

*\*Optional accessories available via Special Order. Call  
1-800-624-4488.*

---



# LED HALF MOON WALL PACK

3 CCT & WATTAGE SELECTABLE

## HIGHLIGHT FEATURES

• 3 CCT & WATTAGE SELECTABLE

• IP65 FOR WET LOCATION USE

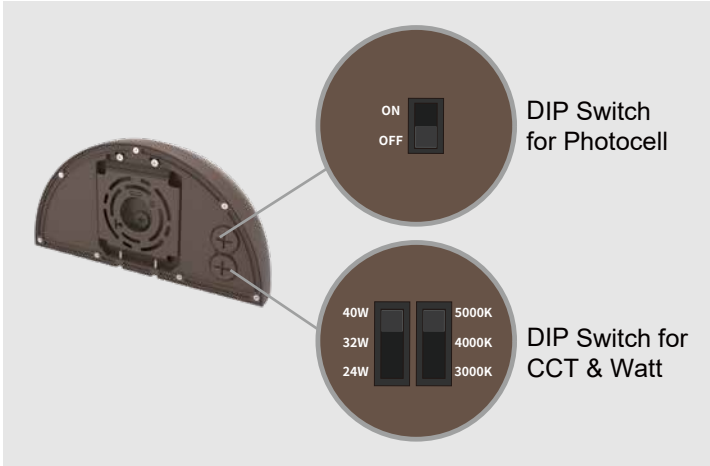

## ACCESSORIES

SENSOR WITH RECEPTACLE AVAILABLE AS OPTIONAL ACCESSORY\*



PHOTOSENSOR\*



MICROWAVE  
SENSOR\*



MICROWAVE SENSOR  
+ BLUETOOTH\*



PIR SENSOR\*



PIR SENSOR  
+ BLUETOOTH\*

EMERGENCY BACK-UP\*



EM BACKUP

Only be applicable to  
40W @ 13" fixture;  
80W @ 18" fixture;

*\*Optional accessories available via Special Order. Call  
1-800-624-4488.*



# LED HALF MOON WALL PACK

3 CCT & WATTAGE SELECTABLE

## DIMENSIONS

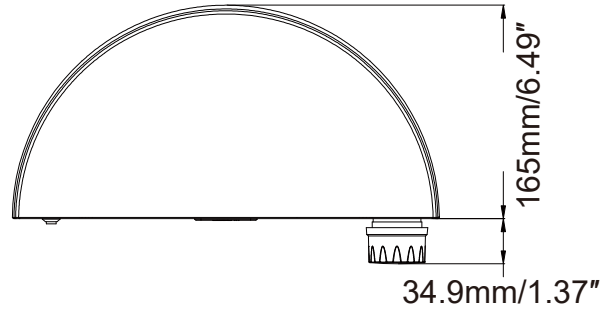
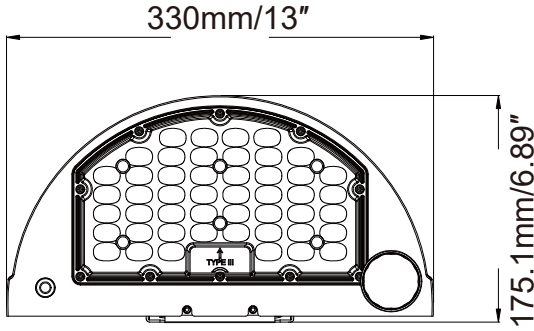

13" 40W/80W

## ELECTRICAL SPECIFICATIONS

Item#	Power	Diameter	Inupt Voltage	Light Efficacy	Lumen Output (±10% / T3)	CRI	Lens	CCT	Working Temp	Warranty
NPS-00364*	40W- 32W- 24W	13inch	120-277V 120-347V	145LPW	5800-4640-3480LM	>80	T2/T3/T4	3K/4K/5K CCT Tunable	-40°C~ +45°C -40°F~ 113°F	5years
PLT-13204	80W- 64W- 48W	13inch	120-277V 120-347V	Up to 158LPW**	Up to 12,274LM**	>80	T2/T3/T4	3K/4K/5K CCT Tunable	-40°C~+45°C -40°F~+113°F	5years

\*Available via Special Order. Call 1-800-624-4488.

\*\*See Selectable Table for full breakdown.

## SELECTABLE TABLE

Wattage	CCT	Lumens	LPW
48W	3000K	7240	151
	4000K	7600	158
	5000K	7440	155
64W	3000K	9230	144
	4000K	10,010	156
	5000K	9700	152
80W	3000K	11,210	140
	4000K	12,274	153
	5000K	11,980	150



# LED HALF MOON WALL PACK

3 CCT & WATTAGE SELECTABLE

## DISTRIBUTION PATTERNS

### AVERAGE ILLUMINANCE MAP

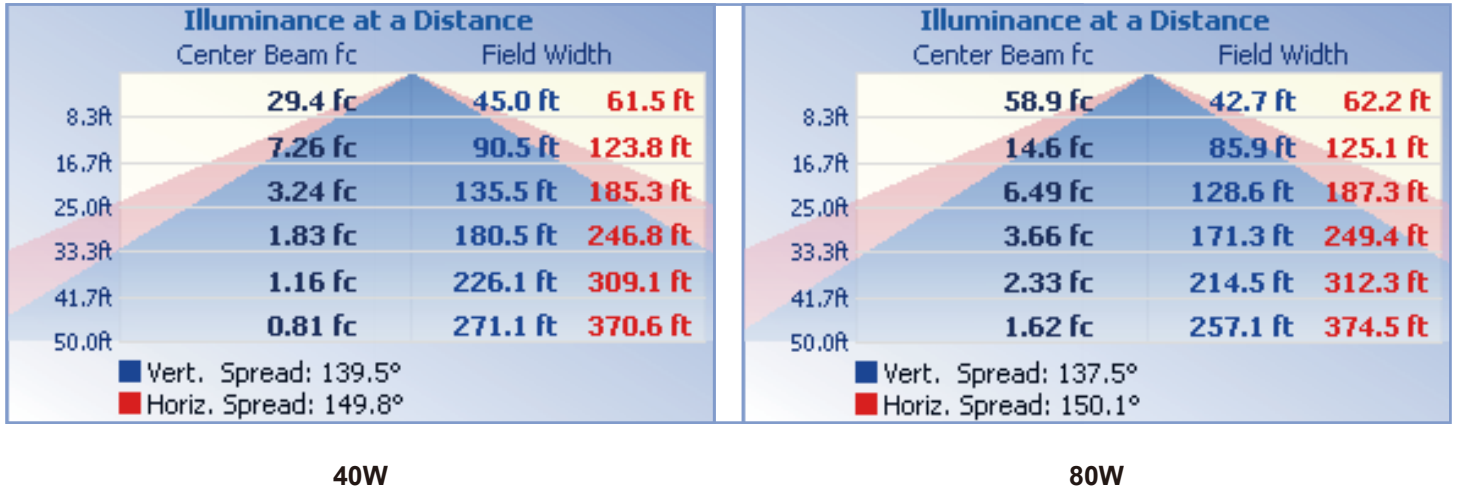

## INTENSITY DISTRIBUTION DIAGRAM IN C PLANS

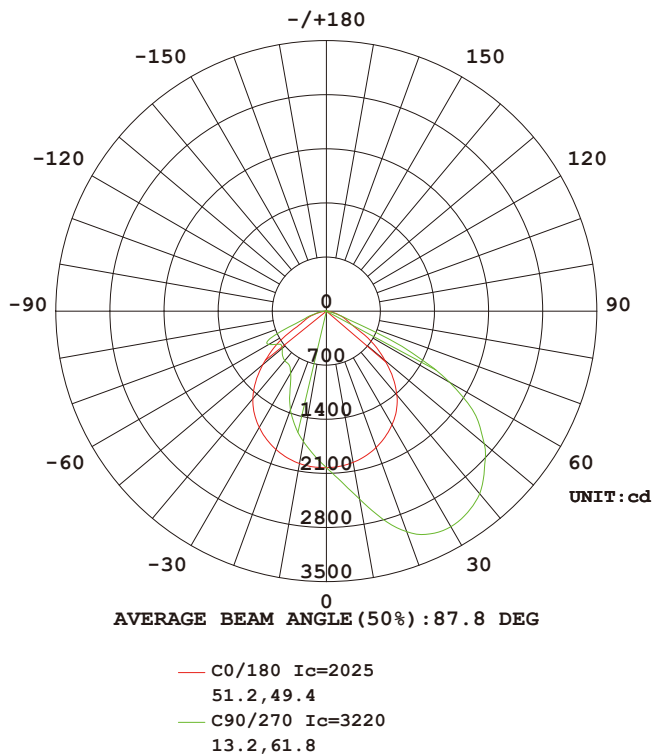

**40W**

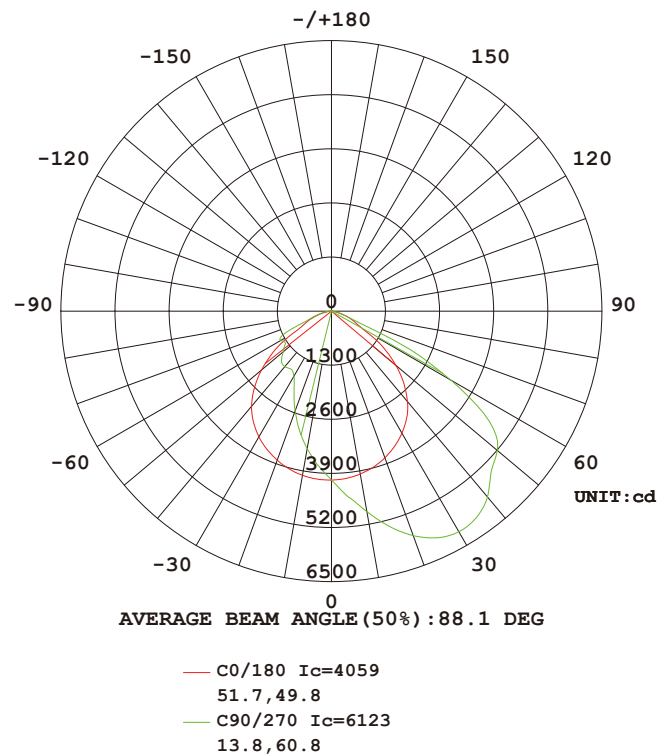

**80W**



# G5 LED HALF MOON WALL PACK

3 CCT & WATTAGE SELECTABLE

## INSTALLATION INSTRUCTIONS

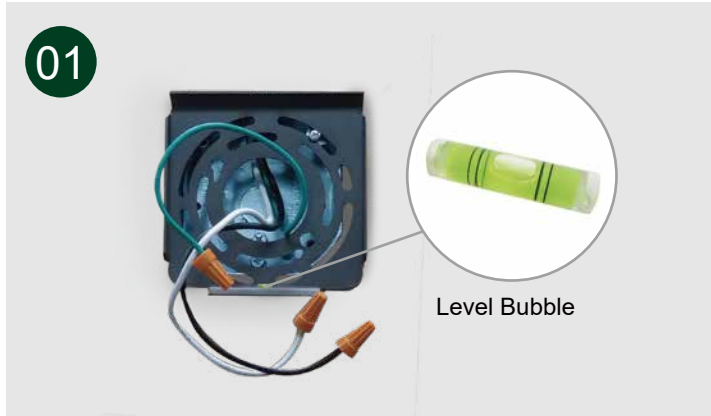

1. Refer to level bubble to place bracket, Install the bracket on the wall.

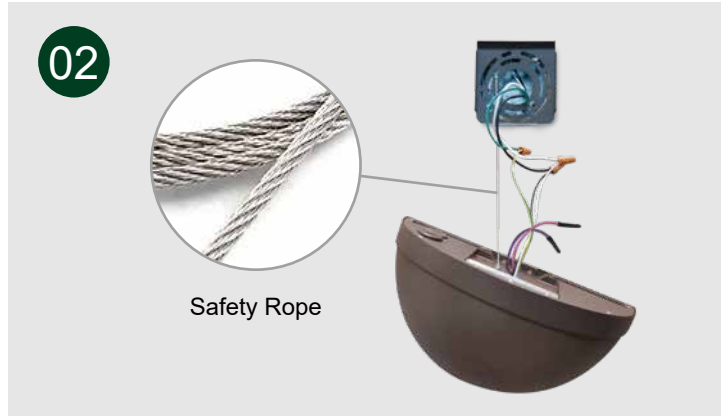

2. Thread safety rope to mounting bracket then fasten the other side to fixture base plate with screw.



3. Lift fixture up and tilt slightly toward wall mounted bracket as shown above. Hook fixture base plate with mounting bracket.



4. Fasten the fixture tightly to the bracket.