



COLOR/WATTAGE SELECTABLE LED OUTDOOR WALL SCONCE W/ DIRECT & INDIRECT LIGHT

WARNING, CAUTION, SAFETY AND INSTALLATION INSTRUCTIONS

WARNING

- Installation, service, and maintenance of luminaries should be performed by a qualified licensed electrician.
- Read all installation instructions carefully before installation.
- Before installing, check the fixture for damage and make sure all accessories are present. If any pieces are missing or damaged, contact the manufacturer immediately.

CAUTION

- Do not use an electric generator to test this fixture.
- In the event of smoke or fire, turn off the power immediately and call a licensed electrician.
- When installed outdoors, this fixture must be mounting at least 6.56' (2m) off the ground.

Installation Instructions

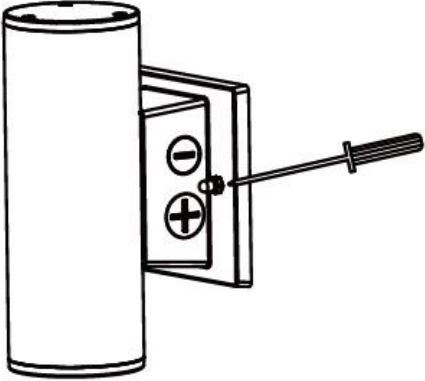
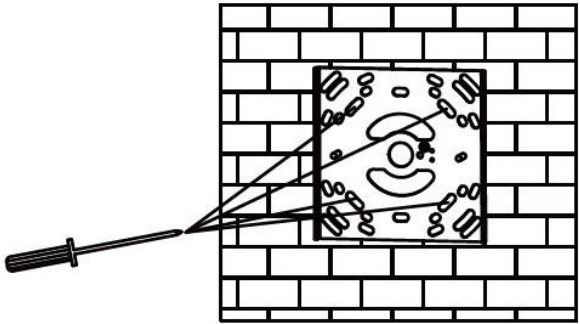
1. Turn off the power.	
2. Use a screwdriver to unscrew both sides and remove the mounting plate.	
3. Attach the mounting plate to the junction box with the included screws.	



COLOR/WATTAGE SELECTABLE LED OUTDOOR WALL SCONCE W/ DIRECT & INDIRECT LIGHT

WARNING, CAUTION, SAFETY AND INSTALLATION INSTRUCTIONS

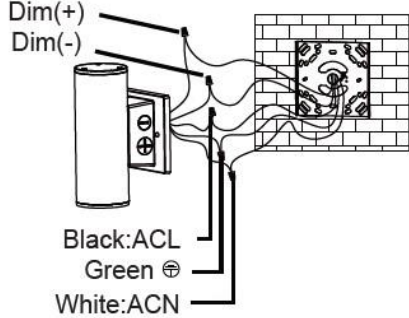
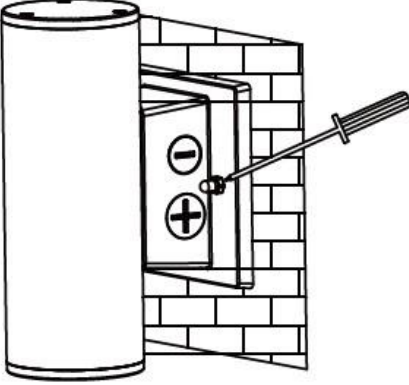
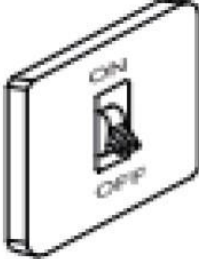
<p>4. Connect the wires properly.</p>	<p>As for the wire color of Dim(+) and Dim(-), please check the light label.</p>  <p>Dim(+) Dim(-) Black:ACL Green ⊕ White:ACN</p>
<p>5. Lock the screws on both sides. The installation is complete.</p>	
<p>6. Turn the power back on.</p>	

Field-Adjustable Wattage & CCT

The end uses may adjust the color temperature and lumen output respectively using the two DIP switched under the plug. Each DIP switch has 3 options (left, middle, right), corresponding to 3 color temperatures and 3 wattages, which can perform the desired output combination.

NOTE: Please turn off the power before adjusting the wattage and color temperature.

1. The DIP switches are located under the plug.
2. Select a wattage and color temperature by sliding the switch to the desired value.



COLOR/WATTAGE SELECTABLE LED OUTDOOR WALL SCONCE W/ DIRECT & INDIRECT LIGHT

WARNING, CAUTION, SAFETY AND INSTALLATION INSTRUCTIONS

Factory Default Settings:

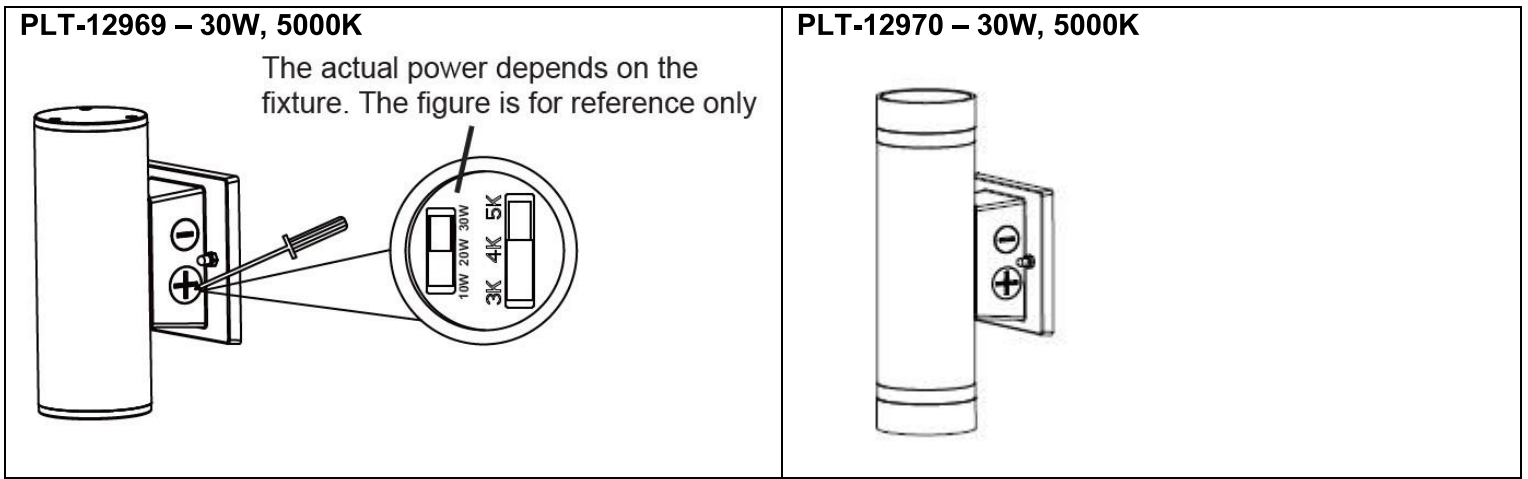

Note: This installation instruction applies to these products vary in appearance.

⚠ WARNING

- Before installing, servicing, or performing routine maintenance upon this equipment, follow these general precautions.
- To reduce the risk of death, personal injury, or property damage from fire, electric shock, falling parts, cuts/abrasions, and other hazards, read all warnings and instructions included with and on the fixture box and all fixture labels.
- Proper grounding is required to ensure safety.
- Power must be turned off at the breaker before installation or maintenance.
- This product must be installed in accordance with the applicable installation code by a person familiar with the construction and operation of the product and the hazards involved.
- Wear gloves and eye protection at all times while installing, servicing, or performing maintenance on the luminaire, and avoid direct eye exposure to the light source while it is on.
- To prevent wiring damage or abrasion, do not expose wiring to edges of sheet metal or other sharp objects.
- Do not install damaged product. Inspect luminaire for damage that may have occurred during transit. If damaged, contact the manufacturer immediately.
- These instructions do not purport to cover all details or variations in equipment nor to provide every possible contingency to meet in connection with installation, operation, or maintenance. Should further information be desired or should particular problems arise which are not covered sufficiently for the purchaser's or owner's purposes, contact the manufacturer.

⚠ ADVERTENCIA

- Antes de instalar, reparar o realizar el mantenimiento de rutina de este equipo, siga estas precauciones generales.
- Para reducir el riesgo de muerte, lesiones personales o daños a la propiedad por fuego, descarga eléctrica, caída de piezas, cortes / abrasiones y otros peligros, lea todas las advertencias y instrucciones incluidas con y en la caja del dispositivo y todas las etiquetas del dispositivo.



COLOR/WATTAGE SELECTABLE LED OUTDOOR WALL SCONCE W/ DIRECT & INDIRECT LIGHT

WARNING, CAUTION, SAFETY AND INSTALLATION INSTRUCTIONS

- Se requiere una conexión a tierra adecuada para garantizar la seguridad.
- Se debe apagar la energía en el disyuntor antes de la instalación o el mantenimiento.
- Este producto debe ser instalado de acuerdo con el código de instalación aplicable por una persona familiarizada con la construcción y operación del producto y los peligros involucrados.
- Utilice guantes y protección para los ojos en todo momento durante la instalación, el servicio o el mantenimiento de la luminaria, y evite la exposición directa de los ojos a la fuente de luz mientras está encendida.
- Para evitar daños o abrasiones en el cableado, no exponga el cableado a bordes de láminas de metal u otros objetos afilados.
- No instale un producto dañado. Inspeccione la luminaria en busca de daños que puedan haber ocurrido durante el tránsito. Si está dañado, comuníquese con el fabricante de inmediato.
- Estas instrucciones no pretenden cubrir todos los detalles o variaciones en el equipo ni proporcionar todas las posibles contingencias a cumplir en relación con la instalación, operación o mantenimiento. Si desea obtener más información o si surgen problemas particulares que no están suficientemente cubiertos para los propósitos del comprador o propietario, comuníquese con el fabricante.