



4' LED T8 BALLAST BYPASS TUBE

WARNING, CAUTION, SAFETY AND INSTALLATION INSTRUCTIONS

WARNING

- Installation, service, and maintenance of luminaries should be performed by a qualified licensed electrician.

CAUTION

- TYPE B LAMP – intended for operation in luminaries with traditional fluorescent-type lampholders wired directly to the branch circuit. This includes both factory-wired luminaries as well as this converted for this purpose under a retrofit program.
- Do not make or alter any holes in the wiring enclosure or components during installation.
- Installers should not disconnect existing wires from lampholder terminals to make new connections at lampholder terminals. Instead, installers should cut existing lampholder leads away from the lampholder and make new electrical connections to lampholder lead wires by employing applicable connectors.
- Install this kit only in the luminaries that have the construction features and dimensions shown in the photographs and/or drawings, and where the input rating of the retrofit kits down not exceed the input rating of the luminaire.
- To avoid potential fire or shock hazard, do not use this retrofit kit in luminaries employing shunted bi-pin lampholders. Instant-start ballasts can be identified by the words “Instant Start” or I.S.” marked on the ballast. This designation may be in the form of a statement pertaining to the ballast itself or may be combined with the marking for the lamps with which the ballast is intended to be used. For example, F40T12/IS.
- Only use the control provided with or specified by these instructions to control this lamp. The lamp will not operate properly when connected to a standard (incandescent) dimmer or dimming control. Only operate with specific dimmer PLTSPA manufactured by PLT Solutions.
- THIS RETROFIT KIT IS ACCEPTED AS A COMPONENT OF A LUMINAIRE WHERE THE SUITABILITY OF THE COMBINATION SHALL BE DETERMINED BY AUTHORITIES HAVING JURISDICTION. PRODUCT MUST BE INSTALLED BY A QUALIFIED ELECTRICIAN IN ACCORDANCE WITH THE APPLICABLE AND APPROPRIATE ELECTRICAL CODES. THE INSTALLATION GUIDE DOES NOT SUPERSEDE LOCAL OR NATIONAL REGULATIONS FOR ELECTRICAL INSTALLATIONS.

NOTICE

- Not for emergency lighting.
- **Minimum Compartment Dimensions** - The units covered by this report were intended to retrofit surface mount, Type IC or non-IC recessed mount listed fluorescent luminaries that use a maximum of 4 tubular lamps. The minimum lamp compartment dimensions are:

Model Number	MINIMUM LAMP COMPARTMENT DIMENSIONS [Length x Width x height] [inch]	Lamp Quantity	Minimum Spacing Between Tube Lamps Center to Center (inch)
PLTSP362141 PLTSP362151	48.4 x 13.4 x 1.8	4	1.6

Installation Instructions

Single-ended Wiring

The below ballast wiring diagrams represent typical configurations. The actual ballast wiring varies according to the ballast model. The socket should be non-shunted.



4' LED T8 BALLAST BYPASS TUBE

WARNING, CAUTION, SAFETY AND INSTALLATION INSTRUCTIONS

Retrofit luminaire with 1 lamp

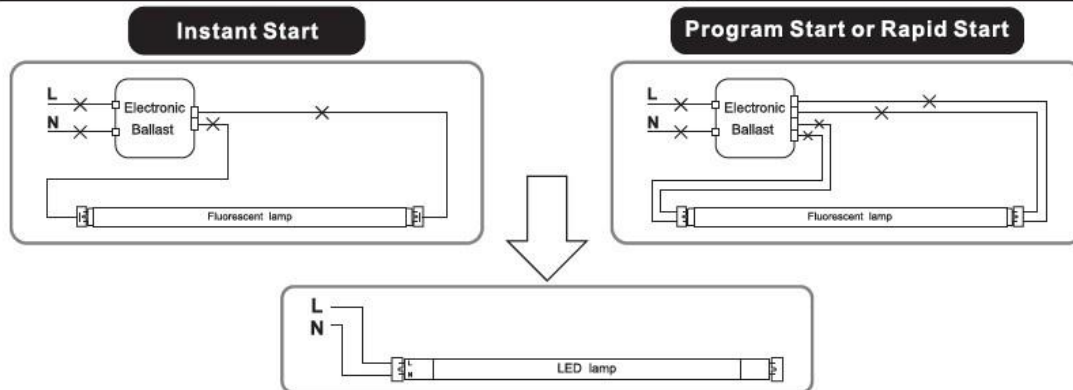

Retrofit luminaire with 2 lamps

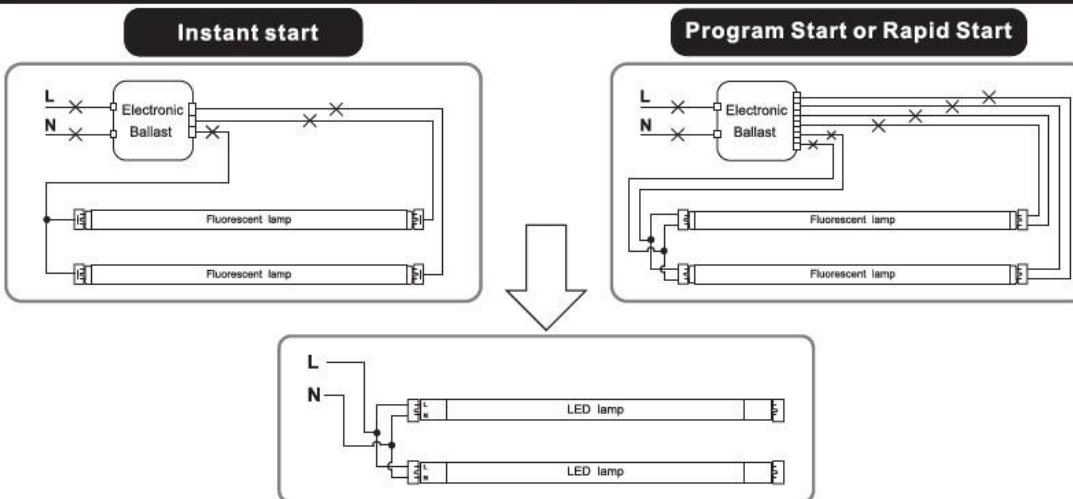

Retrofit luminaire with 3 lamps

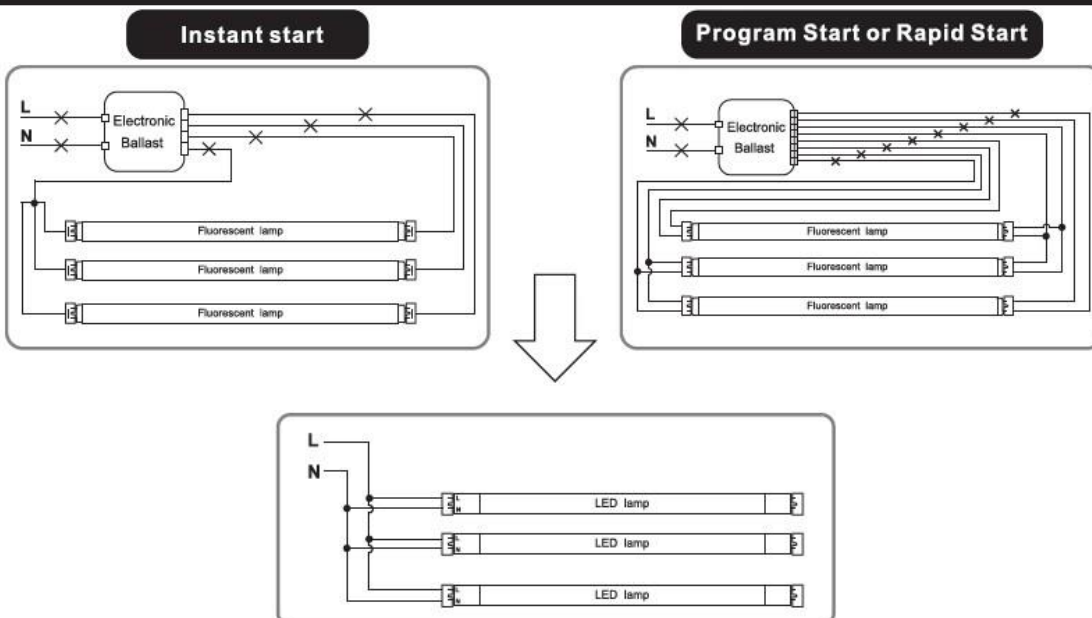



4' LED T8 BALLAST BYPASS TUBE

WARNING, CAUTION, SAFETY AND INSTALLATION INSTRUCTIONS

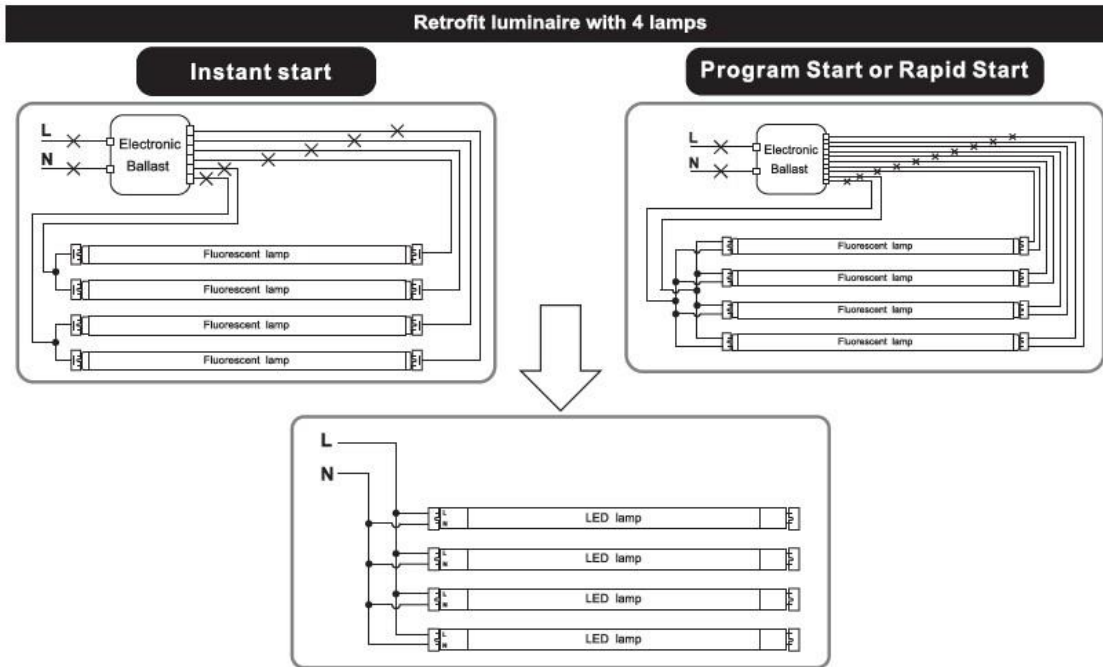

Double-ended Wiring

The below ballast wiring diagrams represent typical configurations. The actual ballast wiring varies according to the ballast model. If the socket is in good condition, it does not need to be changed in order to operate double-ended lamps, regardless of the type of socket. Please make sure one side of the fixture is connected to Live (L) and the other side to Neutral (N).

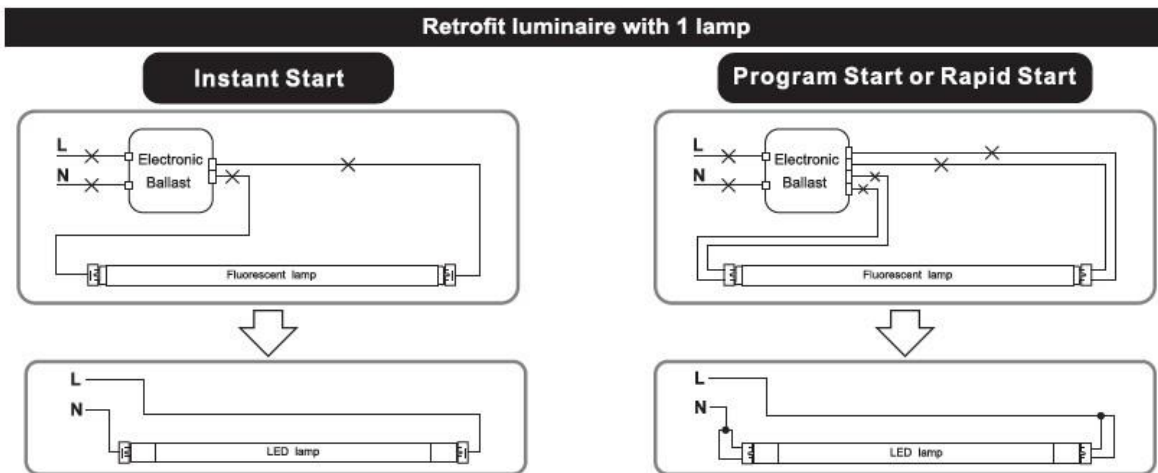



4' LED T8 BALLAST BYPASS TUBE

WARNING, CAUTION, SAFETY AND INSTALLATION INSTRUCTIONS

Retrofit luminaire with 2 lamps

Instant Start

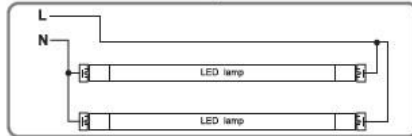
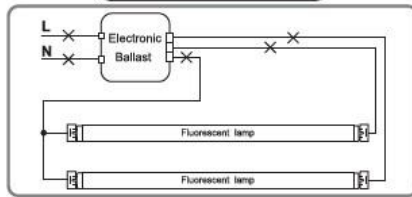

Program Start or Rapid Start

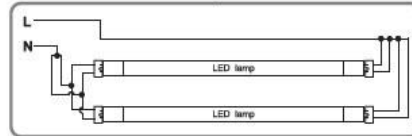
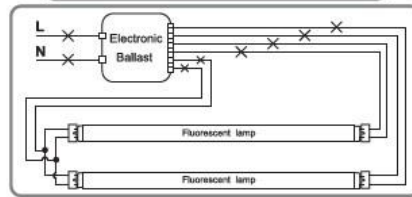

Retrofit luminaire with 3 lamps

Instant Start

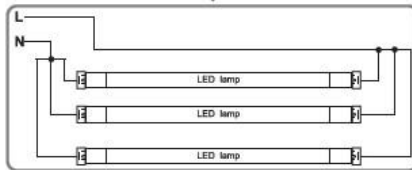
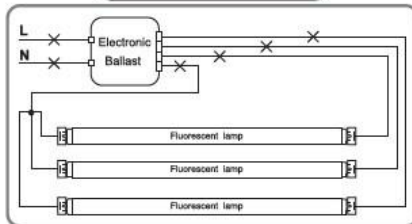

Program Start or Rapid Start

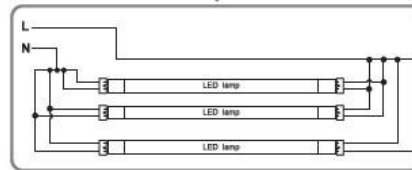
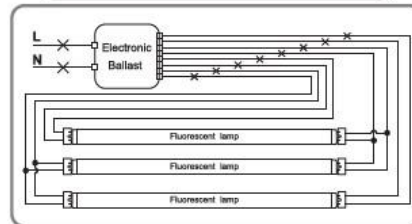

Retrofit luminaire with 4 lamps

Instant Start

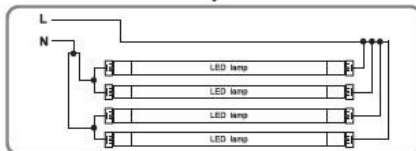
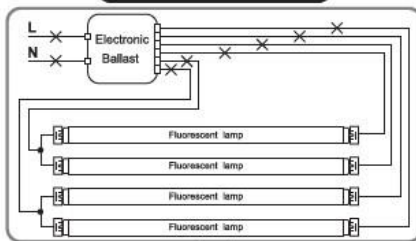

Program Start or Rapid Start

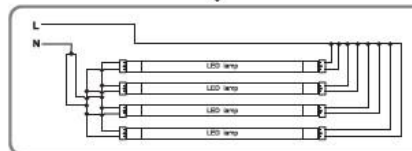
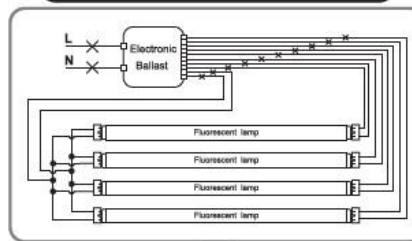



4' LED T8 BALLAST BYPASS TUBE

WARNING, CAUTION, SAFETY AND INSTALLATION INSTRUCTIONS

FCC Warning

- This device complies with Part 15 of the FCC Rules. Operation is subject to the following conditions: (1) this device may not cause harmful interference, and (2) this device must accept any interference received, including interference that may cause undesired operation.

⚠ WARNING

- Before installing, servicing, or performing routine maintenance upon this equipment, follow these general precautions.
- To reduce the risk of death, personal injury, or property damage from fire, electric shock, falling parts, cuts/abrasions, and other hazards, read all warnings and instructions included with and on the fixture box and all fixture labels.
- Proper grounding is required to ensure safety.
- Power must be turned off at the breaker before installation or maintenance.
- This product must be installed in accordance with the applicable installation code by a person familiar with the construction and operation of the product and the hazards involved.
- Wear gloves and eye protection at all times while installing, servicing, or performing maintenance on the luminaire, and avoid direct eye exposure to the light source while it is on.
- To prevent wiring damage or abrasion, do not expose wiring to edges of sheet metal or other sharp objects.
- Do not install damaged product. Inspect luminaire for damage that may have occurred during transit. If damaged, contact the manufacturer immediately.
- These instructions do not purport to cover all details or variations in equipment nor to provide every possible contingency to meet in connection with installation, operation, or maintenance. Should further information be desired or should particular problems arise which are not covered sufficiently for the purchaser's or owner's purposes, contact the manufacturer.

⚠ ADVERTENCIA

- Antes de instalar, reparar o realizar el mantenimiento de rutina de este equipo, siga estas precauciones generales.
- Para reducir el riesgo de muerte, lesiones personales o daños a la propiedad por fuego, descarga eléctrica, caída de piezas, cortes / abrasiones y otros peligros, lea todas las advertencias y instrucciones incluidas con y en la caja del dispositivo y todas las etiquetas del dispositivo.
- Se requiere una conexión a tierra adecuada para garantizar la seguridad.
- Se debe apagar la energía en el disyuntor antes de la instalación o el mantenimiento.
- Este producto debe ser instalado de acuerdo con el código de instalación aplicable por una persona familiarizada con la construcción y operación del producto y los peligros involucrados.
- Utilice guantes y protección para los ojos en todo momento durante la instalación, el servicio o el mantenimiento de la luminaria, y evite la exposición directa de los ojos a la fuente de luz mientras está encendida.
- Para evitar daños o abrasiones en el cableado, no exponga el cableado a bordes de láminas de metal u otros objetos afilados.
- No instale un producto dañado. Inspeccione la luminaria en busca de daños que puedan haber ocurrido durante el tránsito. Si está dañado, comuníquese con el fabricante de inmediato.



4' LED T8 BALLAST BYPASS TUBE

WARNING, CAUTION, SAFETY AND INSTALLATION INSTRUCTIONS

- Estas instrucciones no pretenden cubrir todos los detalles o variaciones en el equipo ni proporcionar todas las posibles contingencias a cumplir en relación con la instalación, operación o mantenimiento. Si desea obtener más información o si surgen problemas particulares que no están suficientemente cubiertos para los propósitos del comprador o propietario, comuníquese con el fabricante.