

LED Luminaires

ProLED Select Compact Linear High Bay Series

- Compact Design To Reduce Shipping Costs, and Reduce Installation Time
- Big performance, 12,000 to 45,000 Lumens in 3 sizes, 4 CCT Selectable SKUs
- Operates in Ambient Temperatures up to 50° C
- Frosted Acrylic Lens To Eliminate Glare

Specifications



Description

The Compact Linear High Bay (CLHB) is designed to meet the needs of the budget-conscious contractor. CLHB boasts robust performance in a smaller footprint to save space and cut down installation time. Designed with a durable die-cast aluminum housing and matte acrylic lens to eliminate glare, the CLHB is a reliable solution for light-duty industrial applications like warehouses, without sacrificing quality needed in retail stores, gymnasiums, and other large indoor spaces.

Performance

- Selectable color temperatures 4000K / 5000K
- 136+ lumens per watt
- 80+ CRI
- L70 lumen maintenance > 50,000 hours
- 0-10V dimming
- 120-277VAC input
- 5 year limited warranty

Construction

- Die-cast aluminum housing
- Acrylic, matte lens
- 1/2" Knock outs on top, sides and bottom
- Chain and v hook mount (standard)
- Wire guard, Pendant Mount, Surface Mount (accessories)
- Optional stepdown transformer
- Optional battery backup

Certifications

- DLC 5.1 Premium
- UL
- cULus
- ROHS compliant
- FCC
- Environmental Rating IP20, UL Damp Location Rating

Controls

- 0-10 VDC dimming standard
- RF bi-level occupancy sensing
- PIR bi-level occupancy sensing

ProLED Select Compact Linear High Bay Series

Ordering Logic

| Series | Base Lumens | Wattage | CCT | Voltage | Options |
|--------------------------------|--|--|-------------------------------------|----------------------------------|---|
| CLHB = Compact Linear High Bay | 1 = 12,010 Lumens 2 = 19,859 Lumens 3 = 25,540 Lumens 4 = 32,450 Lumens | WS = Wattage Selectable 1 (90W / 110W / 130W) 2 (140W / 150W / 165W) 3 (180W / 200W / 220W) 4 (240W / 280W / 320W) | CS = Color Selectable / 4000K/5000K | U = 120-277VAC H = 347-480VAC | EM = Battery Backup PIRMS = Side Mount PIR Occupancy Sensing |

Ordering Information

| Product SKU | Product Code | Product Description |
|-------------|-----------------|---|
| 36100 | CLHB-1-WS-CS-U | ProLED Select Compact Linear High Bay Wattage Selectable (12,010-17,588 lumens, 90W-110W-130W) Color Selectable 4000K-5000K, Universal Voltage 120-277VAC with Chain and V Hook Mount |
| 36101 | CLHB-2-WS-CS-U | ProLED Select Compact Linear High Bay Wattage Selectable (19,859-23,736 lumens, 140W-150W-165W), Color Selectable 4000K-5000K, Universal Voltage 120-277VAC with Chain and V Hook Mount |
| 36102 | CLHB-3-WS-CS-U | ProLED Select Compact Linear High Bay Wattage Selectable (24,540-31,023 lumens, 180W-200W-220W), Color Selectable 4000K-5000K, Universal Voltage 120-277VAC with Chain and V Hook Mount |
| 36103 | CLHB-4-WS-CS-U | ProLED Select Compact Linear High Bay Wattage Selectable (32,450-45,237 lumens, 240W-280W-320W) Color Selectable 4000K-5000K, Universal Voltage 120-277VAC with Chain and V Hook Mount |
| Accessories | | |
| 24875* | DCMS | DC Bi-Level Motion Sensor |
| 24975 | DCMSPIR | DC Bi-Level PIR (Passive Infrared) Motion Sensor |
| 24876 | DCMS-REM | DC Bi-Level Motion Sensor Remote |
| 99986 | LHB/MC | (0-10V) Motion Control Sensor LSXR 610 HL - Side Knockout Install |
| 36148 | CLHB-1-A-WG | Wire Guard for CLHB-1 |
| 36149 | CLHB-2-A-WG | Wire Guard for CLHB-2 |
| 36150 | CLHB-34-A-WG | Wire Guard for CLHB- 3, CLHB-4 |
| 36151 | CLHB-12-M-PEND | Pendant Mount for CLHB-1, CLHB-2 |
| 36152 | CLHB-12-M-SURF | Surface Mount for CLHB-1, CLHB-2 |
| 36153 | CLHB-34-M-PEND | Pendant Mount for CLHB-3 CLHB-4 |
| 36154 | CLHB-34-M-SURF | Surface Mount for CLHB-3 CLHB-4 |
| 36155 | CLHB-BBU-9 | Battery Backup (9W/90Min) for CLHB |
| 36156 | CLHB-12-DR-480V | Driver (150W) 277-480VAC for CLHB-1 CLHB-2 |
| 36157 | CLHB-3-DR-480V | Driver (200W) 277-480VAC for CLHB-3 |
| 36158 | CLHB-4-DR-480V | Driver (320W) 277-480VAC for CLHB-4 |

*When using CLHB-BBU-9 or 16 and DCMS Motion Sensor, DCMS sensor must be set to ∞ standby time on the motion sensor remote. This setting allows fixture to not turn off in EM mode.

ProLED Select Compact Linear High Bay Series

Specifications Table

| | CLHB-1-WS-CS-U | CLHB-2-WS-CS-U | CLHB-3-WS-CS-U | CLHB-4-WS-CS-U |
|------------------------------|--|-------------------------------|-------------------------------|-------------------------------|
| Nominal Wattage | 90W, 110W or 130W Selectable | 140W, 150W or 165W Selectable | 180W, 200W or 220W Selectable | 240W, 280W or 320W Selectable |
| Delivered Lumens | 12,010-17,588 Lumens | 19,859-23,736 Lumens | 24,540-31,023 Lumens | 32,450-45,237 Lumens |
| Efficacy (lm/W) | 134-137 LPW | 141-143 LPW | 140-143 LPW | 140-143 LPW |
| CCT | 4000K/ 5000K Selectable | | | |
| CRI | 80+ | | | |
| L70 Lifetime (hrs) | 50,000 | | | |
| Voltage | 120-277VAC | | | |
| Power Factor | >0.9 | | | |
| Dimming | 0-10V | | | |
| Housing Material | Die-cast Aluminum with Powder Coated Finish | | | |
| Lens | Acrylic | | | |
| Operating Temperature | -40°-50° C | | | |
| BUG | B4 U3 G2 | B4 U5 G1 | B5 U5 G1 | 5 U5 G2 |
| Listings | UL, cUL, DLC 5.1 Premium | | | |
| Environment | Environmental Rating IP20, UL Damp Location Rating | | | |
| Weight | 5.73 lbs | 6.83 lbs | 9.26 lbs | 10.14 lbs |
| Warranty | 5 Years Standard | | | |

Performance Table

| Product Code | Selectable Wattage | 4000K | | 5000K | |
|----------------|--------------------|-----------|----------------|-----------|----------------|
| | | Lumen(lm) | Efficacy(lm/W) | Lumen(lm) | Efficacy(lm/W) |
| CLHB-1-WS-CS-U | 70W | 9590 | 137 | 9870 | 141 |
| | 90W | 12240 | 136 | 12600 | 140 |
| | 130W | 17420 | 134 | 18330 | 141 |
| CLHB-2-WS-CS-U | 140W | 20020 | 143 | 20160 | 144 |
| | 150W | 21150 | 141 | 21450 | 143 |
| | 165W | 23265 | 141 | 23595 | 143 |
| CLHB-3-WS-CS-U | 180W | 25740 | 143 | 26100 | 145 |
| | 200W | 28200 | 141 | 28800 | 144 |
| | 220W | 30800 | 140 | 30580 | 139 |
| CLHB-4-WS-CS-U | 240W | 34800 | 145 | 35040 | 146 |
| | 280W | 39200 | 140 | 40040 | 143 |
| | 320W | 44800 | 140 | 44480 | 139 |

ProLED Select Compact Linear High Bay Series

Dimensions

CLHB-1

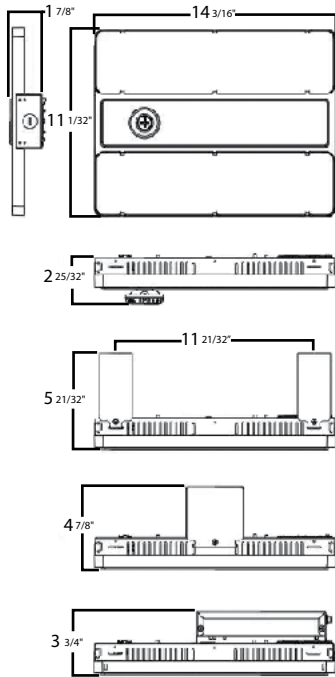

CLHB-2

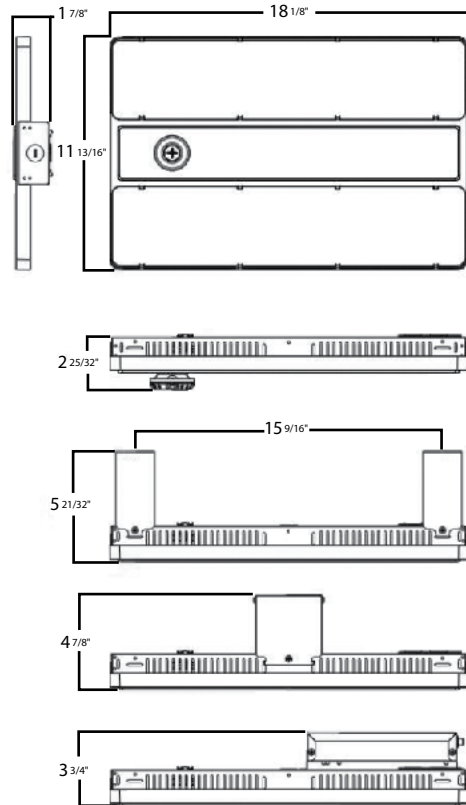

CLHB-3

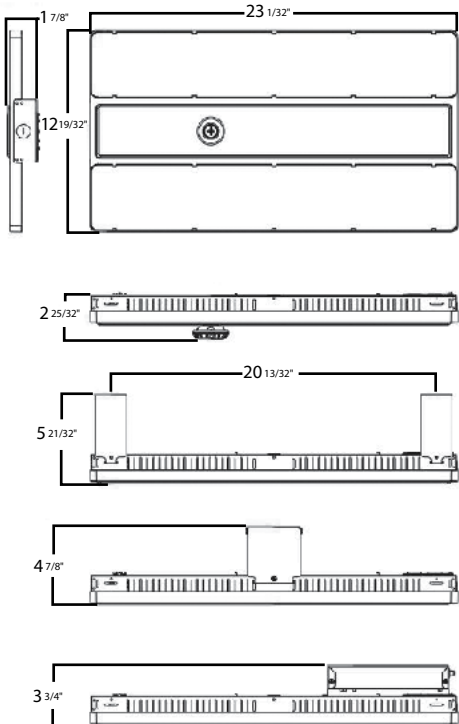

CLHB-4

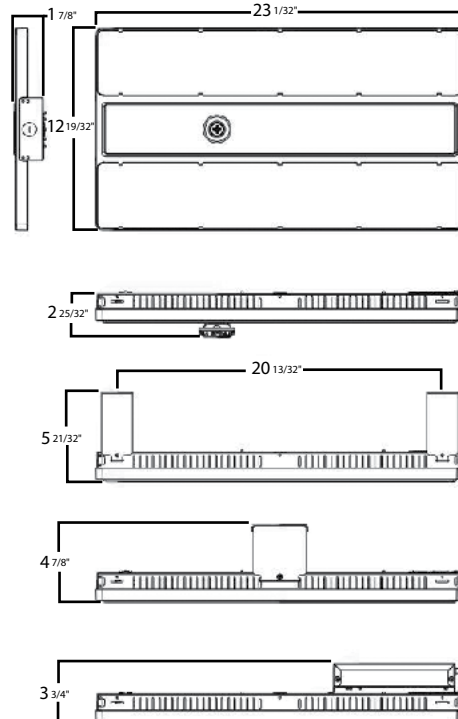

ProLED Select Compact Linear High Bay Series Photometrics

Luminous Intensity Distribution Curve

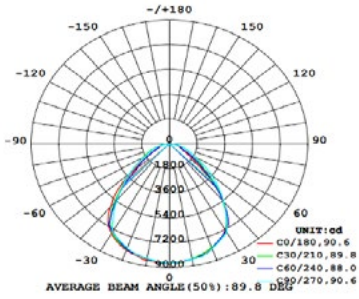

| CLHB-1-WS-CS-U 5000K | | |
|----------------------|--------|---------------|
| ZONE | LUMENS | % LAMP LUMENS |
| (0°-30°) | 2917 | 19.6 |
| (30°-60°) | 3376 | 22.7 |
| (60°-80°) | 742 | 5 |
| (80°-90°) | 102 | 0.7 |
| (0°-30°) | 2968 | 19.9 |
| (30°-60°) | 3706 | 24.9 |
| (60°-80°) | 804 | 5.4 |
| (80°-90°) | 138 | 0.9 |
| (90°-100°) | 7 | 0 |
| (100°-180°) | 122 | 0.8 |

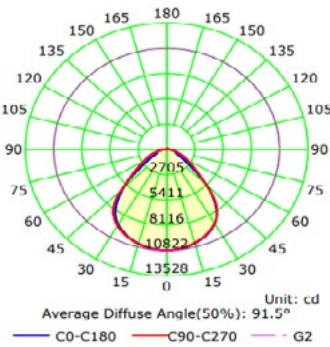

| CLHB-2-WS-CS-U 5000K | | |
|----------------------|--------|---------------|
| ZONE | LUMENS | % LAMP LUMENS |
| (0°-30°) | 4208 | 17.7 |
| (30°-60°) | 5859 | 24.7 |
| (60°-80°) | 1247 | 5.3 |
| (80°-90°) | 166 | 0.7 |
| (0°-30°) | 4257 | 17.9 |
| (30°-60°) | 6260 | 26.4 |
| (60°-80°) | 1335 | 5.6 |
| (80°-90°) | 209 | 0.9 |
| (90°-100°) | 9 | 0 |
| (100°-180°) | 186 | 0.8 |

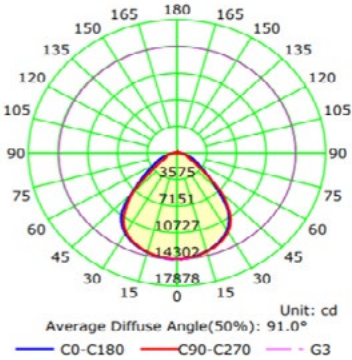

| CLHB-3-WS-CS-U 5000K | | |
|----------------------|--------|---------------|
| ZONE | LUMENS | % LAMP LUMENS |
| (0°-30°) | 5588 | 18 |
| (30°-60°) | 7881 | 25.4 |
| (60°-80°) | 1678 | 5.4 |
| (80°-90°) | 241 | 0.8 |
| (0°-30°) | 5598 | 18 |
| (30°-60°) | 7883 | 25.4 |
| (60°-80°) | 1668 | 5.4 |
| (80°-90°) | 229 | 0.7 |
| (90°-100°) | 11 | 0 |
| (100°-180°) | 246 | 0.8 |

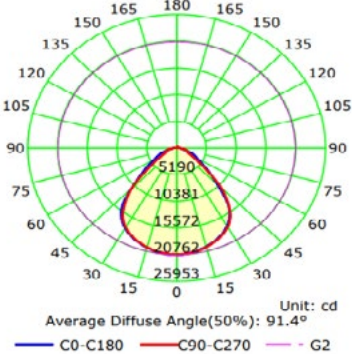

| CLHB-4-WS-CS-U 5000K | | |
|----------------------|--------|---------------|
| ZONE | LUMENS | % LAMP LUMENS |
| (0°-30°) | 8107 | 17.9 |
| (30°-60°) | 11504 | 25.4 |
| (60°-80°) | 2410 | 5.3 |
| (80°-90°) | 325 | 0.7 |
| (0°-30°) | 8124 | 18 |
| (30°-60°) | 11626 | 25.7 |
| (60°-80°) | 2438 | 5.4 |
| (80°-90°) | 339 | 0.7 |
| (90°-100°) | 16 | 0 |
| (100°-180°) | 350 | 0.8 |

*For complete photometry/IES files, please contact the factory. For all IES files please visit halcolighting.com

ProLED Select Compact Linear High Bay Series

Controls

Motion Sensor / PIR Sensor:

| Product SKU | Product Code | Product Description |
|-------------|--------------|---|
| 99986 | LHB/MC | (0-10V) Motion Control Sensor LSXR 610 HL - Side Knockout Install |

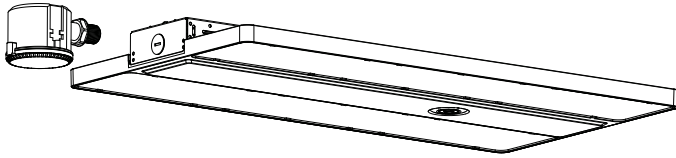

Wiring Instruction

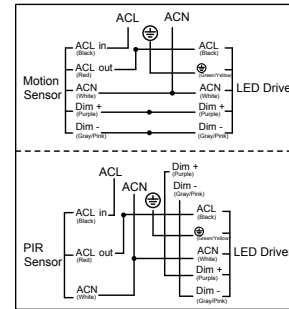

Motion Sensor / PIR Sensor:

| Product SKU | Product Code | Product Description |
|-------------|--------------|---|
| 24975 | DCMSPIR | DC Bi-Level PIR (Passive Infrared) Motion Sensor, order minimum one remote (24876) per site |
| 24875 | DCMS | DC Bi-Level Motion Sensor, order minimum one remote (24876) per site |
| 24876 | DCMS-REM | DC Bi-Level Motion Sensor Remote |

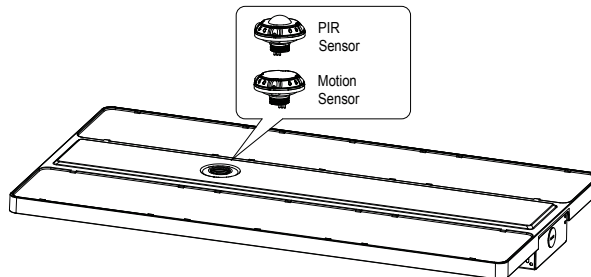

ProLED Select Compact Linear High Bay Series

Wire Guard for CLHB-1

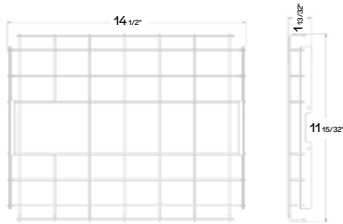

Pendant Mount for CLHB-1, CLHB-2

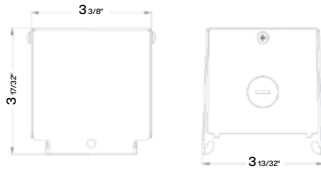

Surface Mount for CLHB-1, CLHB-2

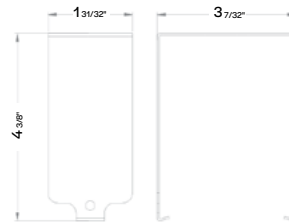

Wire Guard for CLHB-2

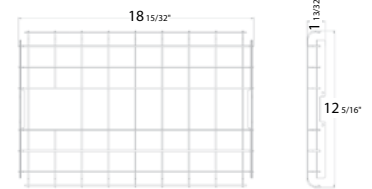

Pendant Mount for CLHB-3 CLHB-4



Surface Mount for CLHB-3 CLHB-4

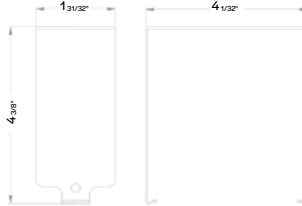

Wire Guard for CLHB-3, CLHB-4



Accessories Ordering Information

Accessories purchased separately

| Product SKU | Product Code | Product Description |
|-------------|-----------------|--|
| 36148 | CLHB-1-A-WG | Wire Guard for CLHB-1 |
| 36149 | CLHB-2-A-WG | Wire Guard for CLHB-2 |
| 36150 | CLHB-34-A-WG | Wire Guard for CLHB-3, CLHB-4 |
| 36151 | CLHB-12-M-PEND | Pendant Mount for CLHB-1, CLHB-2 |
| 36152 | CLHB-12-M-SURF | Surface Mount for CLHB-1, CLHB-2 |
| 36153 | CLHB-34-M-PEND | Pendant Mount for CLHB-3 CLHB-4 |
| 36154 | CLHB-34-M-SURF | Surface Mount for CLHB-3 CLHB-4 |
| 36155 | CLHB-BBU-9 | Battery Backup (9W/90Min) for CLHB |
| 36156 | CLHB-12-DR-480V | Driver (150W) 277-480VAC for CLHB-1 CLHB-2 |
| 36157 | CLHB-3-DR-480V | Driver (200W) 277-480VAC for CLHB-3 |
| 36158 | CLHB-4-DR-480V | Driver (320W) 277-480VAC for CLHB-4 |

*When using CLHB-BBU-9 or 16 and DCMS Motion Sensor, DCMS sensor must be set to ∞ standby time on the motion sensor remote. This setting allows fixture to not turn off in EM mode.