



COMPACT UFO HIGH BAY



PRODUCT FEATURES

- 145lm/w fixture efficacy, high performance and reputable brand LED chip and driver
- Optimized aluminum alloy housing design for superior thermal management
- Clear polycarbonate lens with no risk of lamp breaking for safe industry applications
- Selectable CCT & Watt options to cut SKUs and inventory cost
- Compact size for easy operation and transportation
- 0-10V dimming
- 60*/90/120*deg lens options
- Plug & Play microwave sensor options*
- Aluminum reflector options*
- IP65 and IK10 rated
- EM backup options*
- BUG Rating - B4-U3-G1
- 4kV surge protection

*Available via Special Order. Call 1-800-624-4488.



COMPACT UFO HIGH BAY

SPECIFICATIONS

Part No.	Power	Lumen output** (+5%)	CCT	Dimming	Beam Angle	CRI	Input Voltage	Operation Temp.	Warranty
PLT-13129	150W 150W/120W/100W Selectable	21750lm/17400lm/14500lm	3000K/4000K/ 5000K Selectable	0-10V	60°*/90°/ 120°*	80	120-277V	-45~+45 °C	5years
NPS-00258*	240W 240W/220W/200W Selectable	34800lm/31900lm/29000lm							

DIMENSIONS

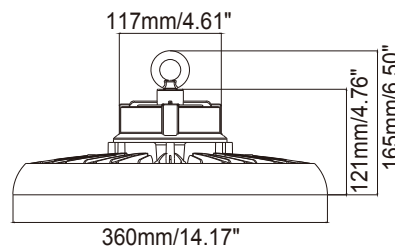
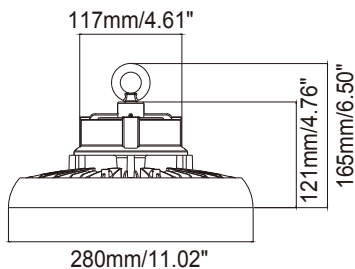
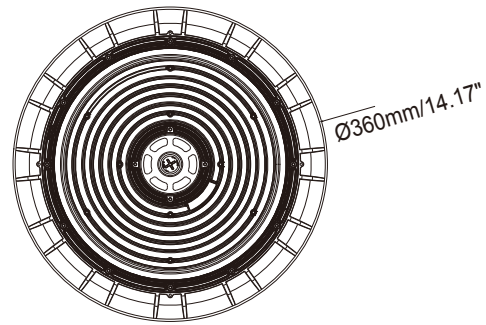
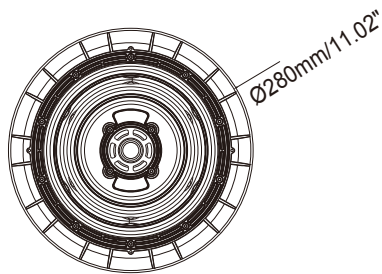

280mm/11.02"

360mm/14.17"

150W

240W*

PHOTOMETRY

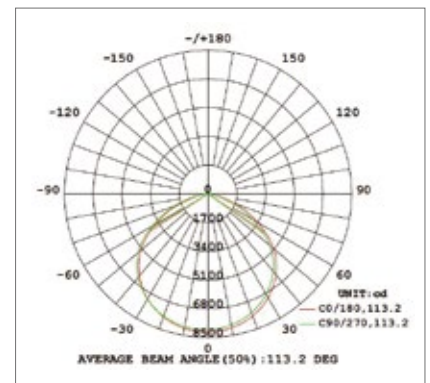
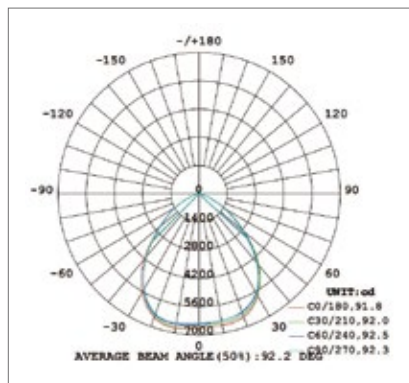
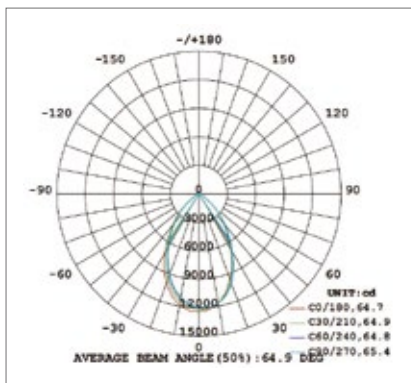

60°*

90°

120°*



COMPACT UFO HIGH BAY

WATT AND CCT SELECTABLE DIP SWITCH

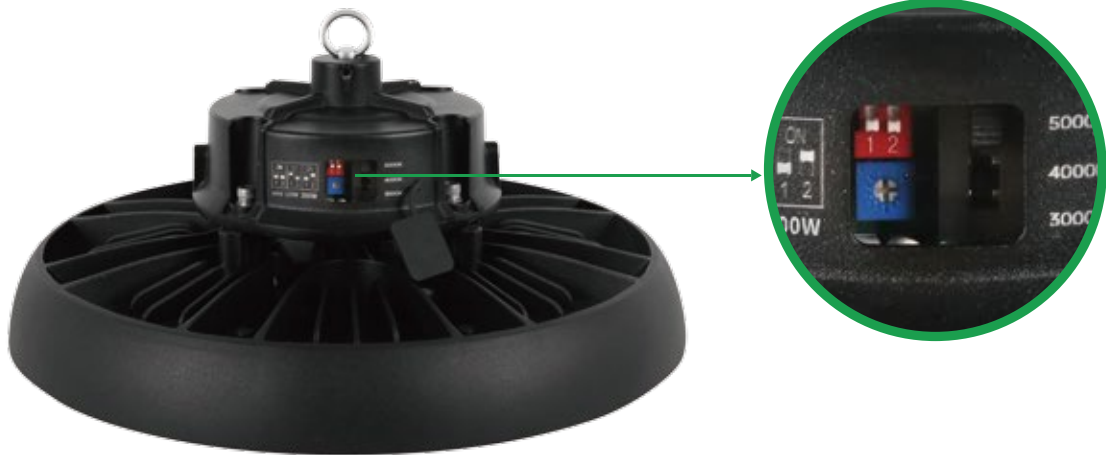

Watt Select:

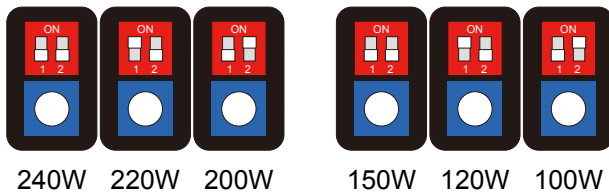

CCT Select:

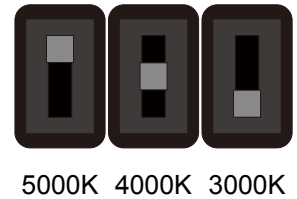

ACCESSORIES



REMOTE CONTROL
NPS-00191*



MICROWAVE SENSOR
NPS-00192*



PIR SENSOR
NPS-00193*



EM BACKUP
NPS-00194*



REFLECTOR*



YOKE MOUNT
PLTS-12378

*Available via Special Order. Call 1-800-624-4488.



COMPACT UFO HIGH BAY

EM BACKUP - NPS-00194*

FEATURES

- UL listed for field or factory installation,CEC title 20 compliant
- Compliance with American NFPA 101 life Safety Code.
- Easy installation,no need to open up a luminaire to connect this device to the driver,connect with the led lamp directly.
- With built-in junction box.
- 2 -in- 1 LED test switch and indicator light included
- Manual testing via remote control (optional)
- Monthly/annual self-testing
- With multi-protection function:
Battery overcharge protection; Battery over-discharge protection;
Output overload protection; Short-circuit protection; Open load protection
- 5 years limited warranty



Em backup



Em backup for selectable CCT & Watt UFO

MOUNTING CONFIGURATION

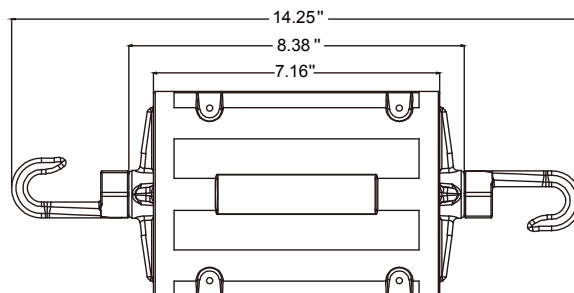
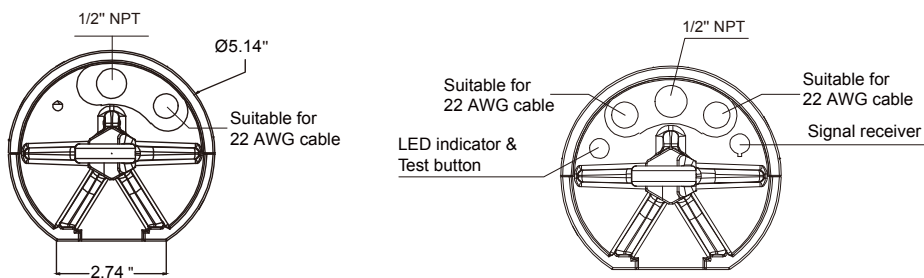

*Available via Special Order. Call 1-800-624-4488.



COMPACT UFO HIGH BAY

SELECTABLE TABLE

SKU	Wattage	CCT	Lumens	LPW
PLT-13129	100W	3000K	15,000	150
		4000K	16,500	165
		5000K	16,000	160
	120W	3000K	16,800	140
		4000K	19,200	160
		5000K	18,600	150
	150W	3000K	21,000	140
		4000K	23,250	160
		5000K	22,800	150