



PLT-13078 - 150W, 22,544 Lumens, 400W MH Equal, 5000K, White Finish, Sensor Ready



DIMENSIONS

Pendent

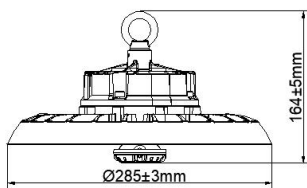
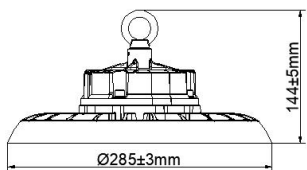

Surface-mounted w/ PLTS-12377

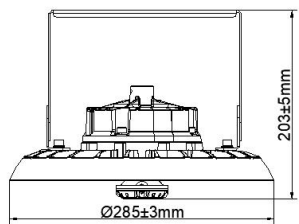
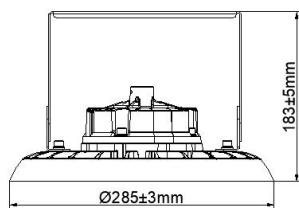

ADVANTAGE

- UL cUL
- Lumileds or Samsung Chip.
- Input voltage 120-277VAC.
- Output constant current can be adjusted through output cable with 0-10V.
- No UV or IR in the beam.
- Easy to install and operate.
- Energy saving, long lifespan.
- Light is soft and uniform,.
- Instant start, NO flickering, NO humming.
- Green and eco-friendly without mercury.

APPLICATION

- Warehouse, factory and workshops;
- Highway toll station;
- Exhibition hall;
- Gymnasium and supermarkets, etc.

SPECIFICATIONS

OPTICAL	Input Power (Tolerance : ±10%)	150W				
	Color Temperature	3500K*	4000K	4500K*	5000K*	5700K*
	Lumen (Tolerance : ±10%)	21493.2	22,544	21798.6	21951.3	22104.0
	Efficacy (Tolerance : ±3%)	144.34	150	145.85	146.87	147.35
	CRI	>80				
	Color Consistency	<6 Steps (or <6 SDCM)				
	UGR	<28 (X=4H, Y=8H; S/H=1; Reflectances: 70%/50%/20%)				
	Diffuser Type	PC Lens				
	Beam Angle (50%) (Tolerance : ±15%)	90 Degree				
ELECTRICAL	Input Voltage and Frequency	120-277VAC, 50/60Hz				
	PF (Tolerance : -3%)	≥0.9				
	THD (Tolerance : +5%)	≤20%				
	Flicker Percent	<5%				
	Driver Brand	Lifud Driver				
	Driver Model	LF-FHB150YAIV				
	Driver Surge protection	L/N-PE: 6kV, L-N: 6kV				
	Dimming	0-10V dimming standard				
	Sensor type	Daylight Sensor ¹ , Occupancy Sensor ² , Multifunction Sensor ³ , Integral Sensor Receptacle				
	Optional Accessory	Motion Microwave Sensor ⁴ , Motion PIR Sensor ⁵ Surge-protective Device ⁶				
MATERIALS	LED Brand	Lumileds				
	LED Type	SMD2835				
	LED QTY	240 PCS				
	Housing	Die-cast aluminum				
	Housing Color	Black (White or Customized*)				
	Waterproof Rating	WET (IP65)				
OTHERS	Operating Temperature	Without Motion Sensor: -40°C TO 50°C				
		With Motion Sensor: -30°C TO 50°C				
	Storage Temperature	-40°C TO 80°C				
	Operating Humidity	20% - 90% RH				
	Storage Humidity	10% - 95% RH				
Warranty	5 years					

*Alternate color temperatures and/or finishes available via Special Order. Please call 1-800-624-4488.

5000K Version w/ black finish - PLT-13074

PACKAGE

Lamp Type	Carton Size	Qty / Carton	Net Weight / Carton	Gross Weight / Carton
Pendent	300*300*130mm	1 PC	1.8KG	2.5KG
Surface-mounted	300*300*130mm	1 PC	2.4 KG	3.1KG

Tolerance of Carton Size: ±15 MM, Tolerance of Weight: ±10%.

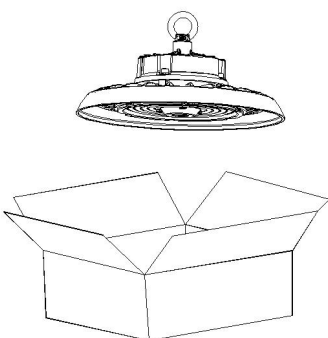

Optional Accessories:

- ¹Daylight Sensor - NPS-00014*
- ²Occupancy Sensor - PLT-12844
- ³Multifunction Sensor - NPS-00016*
- ⁴Motion Microwave Sensor - NPS-00041*
- ⁵Motion PIR Sensor - NPS-00042*
- ⁶Surge-protective Device - NPS-00029*
- Sensor Remote - PLTS-12281 (use w/ PLT-12844)

***Special order items. Please call 1-800-624-4488 for more information**

LIGHT DISTRIBUTION TESTING PARAMETERS

Photometric Results

CIE Class: Direct	Total Rated Lamp Lumens: 21493.2 lm
Measurement Flux: 21493.2 lm	Efficiency: 100%
Downward Ratio: 99%	Upward Ratio: 1%
Horizontal Diffuse Angle(10%,50%): H123.9,H83.6	
Vertical Diffuse Angle(10%,50%): V123.9,V83.2	
Luminaire Efficacy Rating (LER): 144.39	C0r0 Intensity: 11327.96 cd
Max. Intensity: 11549.21 cd	Pos of Max. Intensity: H0 V25
S/MH(C0/C180): 1.31	S/MH(C90/C270): 1.28

The Average Illuminance Effective Figure

Flux Out: 15452.43lm

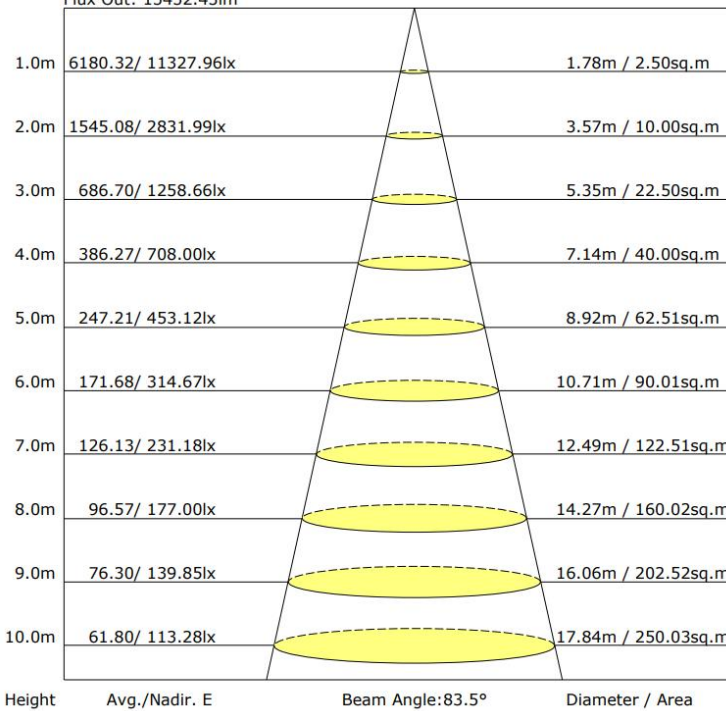

Luminous Intensity Distribution Curve

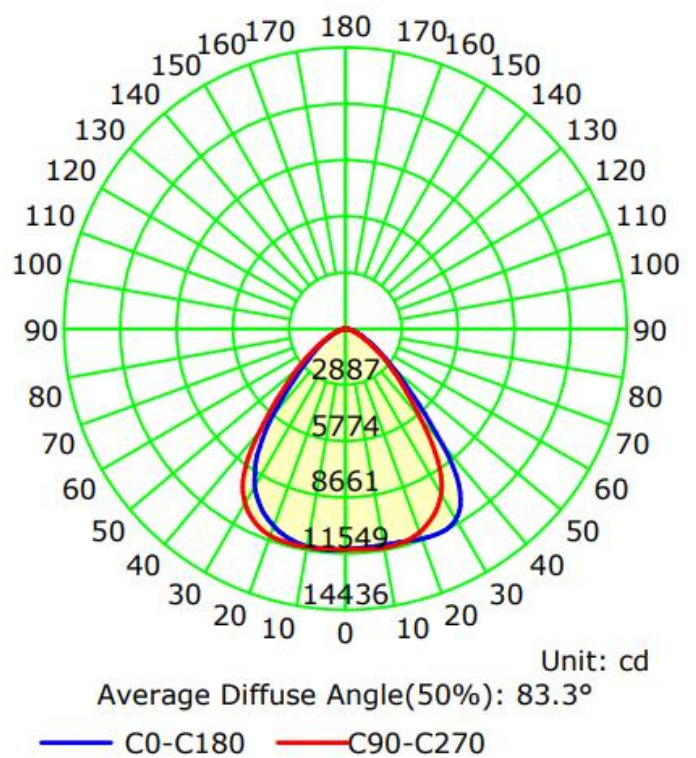

NOTICE FOR USER

- Please turn off power before installation or maintenance.
- Verify that supply voltage is correct by comparing it with the luminaire label information. Please make sure the wiring is insulated.
- Installation, service, and maintenance of luminaires should be performed by a qualified licensed electrician.

TROUBLESHOOTING

Problem	Solution
Flickering Light	Turn off the power, then turn on again after 3 minutes. If the light continues to flicker, call a licensed electrician.
Fixture not turning on	Check the electrical connection.