

# UP/DOWN

## ARCHITECTURAL LED LINEAR FIXTURE

Minimalist Design, combines brilliant aesthetics with space-filling light.

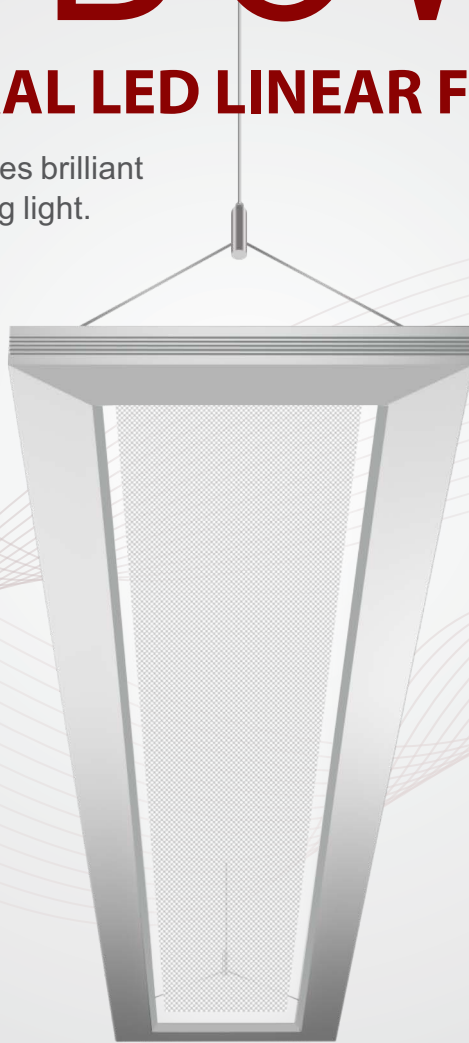



## Maximized Performance

Both ambient and directional, it guides light up for general illumination as well as aiming it precisely down for specific functionally. It is perfect for applications that include conference rooms, open offices, retail settings, anywhere you want to make a statement.

*Distinctive*  
*Flexible*  
*Practical*  
*Simple*

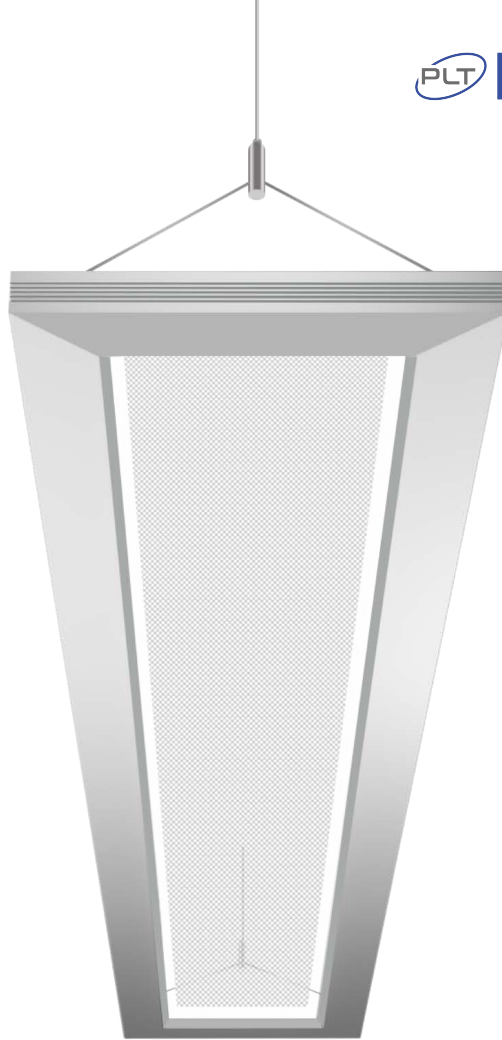

## Minimalist Design, combines brilliant aesthetics with space-filling light.

It creates an exceptionally thin profile that appears to float across your ceiling landscape. When turned on, it produces a perfectly even glow, and while off, it is nearly transparent with LEDs hidden inside the frame.



## Transparent Optics

Timeless transparent edge-lit linear has been designed to efficiently deliver and control light for direct-indirect and direct pendant lighting applications where visual comfort and low energy consumption are the primary requirements.

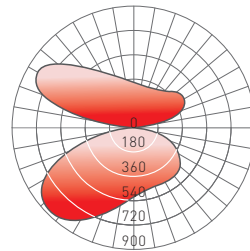

AVERAGE BEAM ANGLE(50%): 319.7°

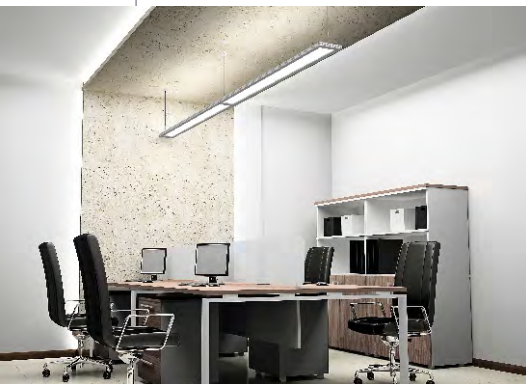

## Up/Down Linear

It is a modern expression of lighting technology contained within a sleek and elegant for ideally suited for general illumination.



Project in Automotive Dealer Office  
in California, USA



## Built-in Driver

All drivers are built-in, and can be replaced easily, which is more convenient to fix and maintain.

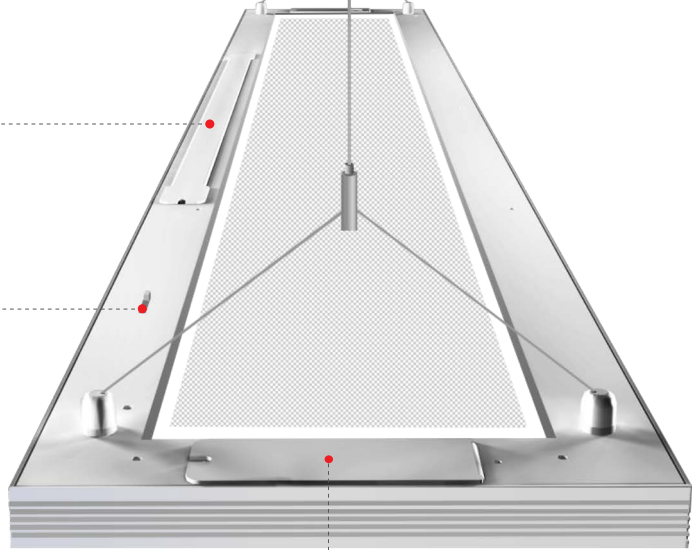

## CCT Adjustable- Puts flexibility at your fingertips

It is truly a modern luminaire that provides flexibility in how a space is illuminated, featuring independently-adjustable CCT by using dip switch, creating your optimal lighting experience.

- Adjustable CCT from 3000K, 3500K and 4000K
- Designed for all projects
- Lower your stock risk

## Continuous Runs Create Linear Lighting Atmosphere

One power can feed multiple lamps to minimize installation time and save labor cost. Runs of luminaires that are up to 40ft in 120VAC.

**PLT-90279** - 40W, 3000/3500/4000K, White Finish, 4'

**PLT-90280** - 80W, 3000/3500/4000K, White Finish, 8'

**PLT-90453** - 40W, 3000/3500/4000K, Black Finish, 4'

**PLT-90454** - 80W, 3000/3500/4000K, Black Finish, 8'



## Innovative Joining Design

It's highly engineered luminaire joining design allows for simple and intuitive assembly in the field without tools. Its junction plate ensures that luminaire rows snap into a laser straight line.

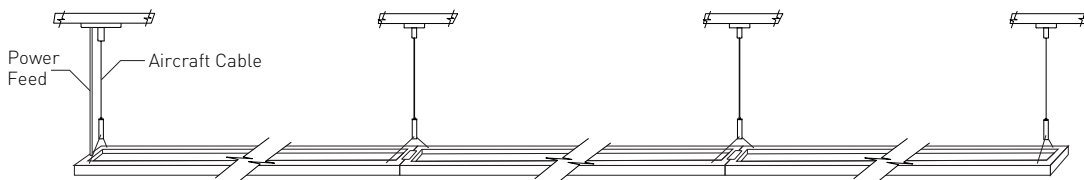

**4'** Connect 9 pcs together in 120V AC and 20 pcs in 277V AC

**8'** Connect 4 pcs together in 120V AC and 10 pcs in 277V AC







# Application Flexibility

## T-grid Or Dry Ceiling Compatible

### Canopy Style

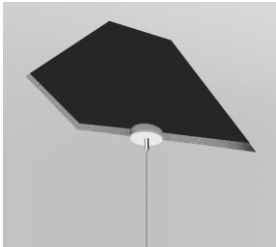
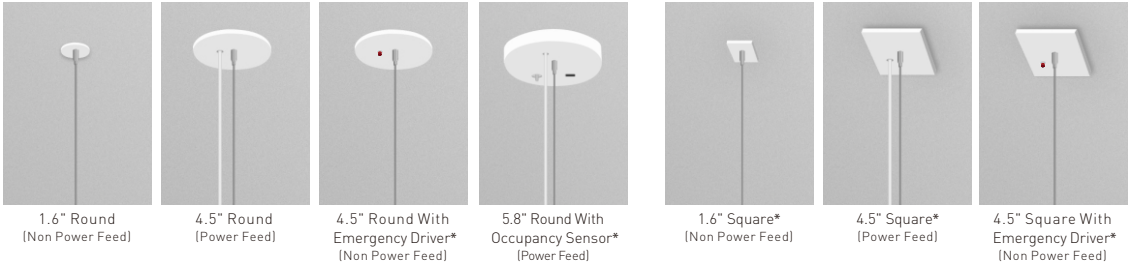

### Dry Ceiling / Off Grid

"Various Hard Ceilings"  
(Mount to J-box)

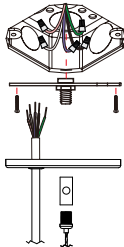

### Drop Ceiling / On Grid\*

Suspending the luminaire in the T-grid. Compatible for various T-grid, including 9/16" Flat, 9/16" Slot, 15/16" Flat.

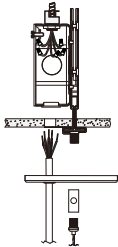

\*Available via Special Order. Please call 1-800-624-4488.