

Installation Instruction

⚠ WARNING

- To reduce the risk of death, personal injury or property damage from fire, electric shock, falling parts, cuts/abrasions, and other hazards read all warnings and instructions included with and on the fixture box and all fixture labels.
- Before installing, servicing, or performing routine maintenance upon this equipment, follow these general precautions.
- Commercial installation, service and maintenance of luminaires should be performed by a qualified licensed electrician.
- For the installation: If you are unsure about the installation or maintenance of the luminaires, consult a qualified licensed electrician and check your local electrical code.
- To prevent wiring damage or abrasion, do not expose wiring to edges of sheet metal or other sharp objects.
- Do not make or alter any open holes in an enclosure of wiring or electrical components during kit installation.

⚠ WARNING

- Turn off electrical power at fuse or circuit breaker box before wiring fixture to the power supply.
- Turn off the power when you perform any maintenance.
- Verify that supply voltage is correct by comparing it with the luminaire label information.
- All wiring connections should be capped with UL approved wire connectors.

⚠ CAUTION

- Avoid direct eye exposure to the light source while it is on.
- Account for small parts and destroy packing material, as these may be hazardous to children.
- Risk of burn. Disconnect power and allow fixture to cool before changing or handling fixture.

NOTICE: Green ground screw provided in proper location. Do not relocate.

NOTICE: Minimum 90°C supply conductors.

NOTICE: Specifications and dimensions subject to change without notice.

NOTICE: Suitable for Dry or Damp location, Type IC.

General Wiring Diagram

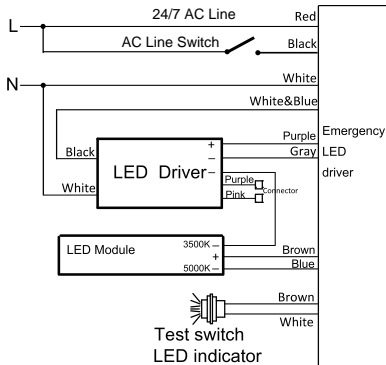

Any further questions or interests, pls visit

www.pltsolutions.com

Installation Instruction

INSTRUCTIONS:

Always turn off the power supply from main circuit breaker first!

- Recessed Mounting

Figure 1

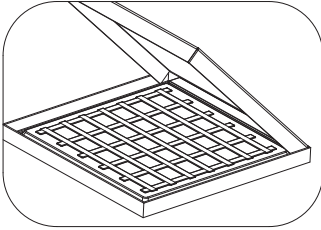

Carefully unpack unit and properly inspect for defects before installing. Wear work gloves to prevent dirt and oil from being transferred to the luminaire. If cleaning is needed, use gloves and a dry cottoncloth. It is not recommended to use hazardous chemicals.

Figure 2

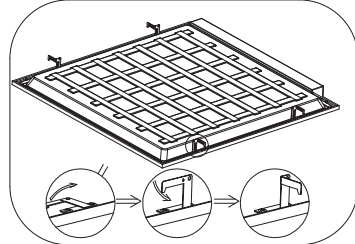

Lift up four mounting clips on the sides of the luminaire. You can do it by hand (Do wear work gloves) or use pliers

Figure 3

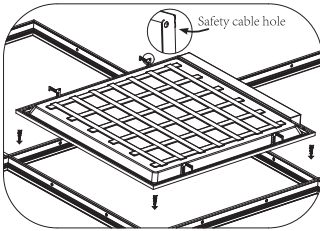

Insert luminaire into T-bar ceiling grid. Secure safety cable to connection hole as needed to meet local seismic requirements. Safety cable and method of attachment to the building provided by contractor according to local building codes.

Figure 4

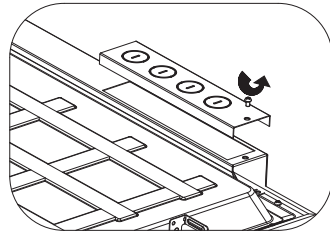

Remove electrical enclosure cover. Carefully remove knockout for AC line input wires and 0-10V control line. Install listed electrical fittings in the knockout holes for wire protection if needed.

Figure 5

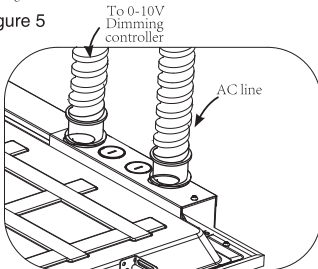

Plug in AC line(L and N, and GND) to the LED Driver using 18-14AWG Wire. When connecting 0-10V dimming controller, wires must run through a separate knockout hole equipped with an appropriate electrical fitting.

Figure 6

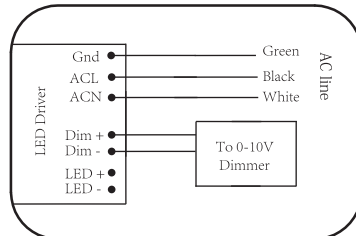

Follow wire connection instructions. When using the 0-10V dimming controller Run wires from controller through a different knockout than the AC input wire. Don't forget to return the electrical enclosure cover and tighten the screws.



Any further questions or interests, pls visit

www.pltsolutions.com

Installation Instruction

Field-Adjustable Wattage & CCT

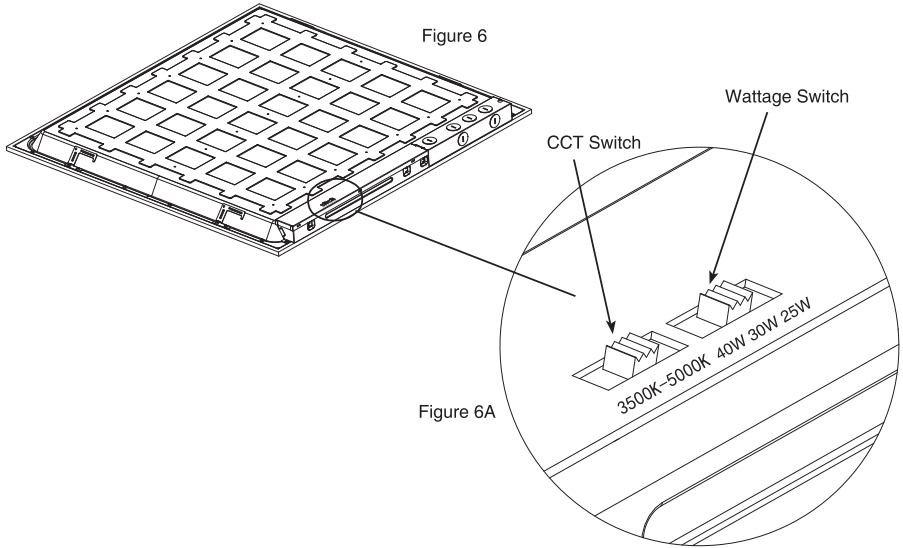

The end users may adjust the color temperature and lumen output respectively by the two DIP switch buttons integrated into the driver. Each DIP switch is accommodated with 3 options (left, middle and right), corresponding to 3 color temperatures and 3 powers respectively, which can perform the desired color temperature and lumen output combination.

Factory Settings: CCT : 5000K
Wattage: 40W for the 2*2 PLT-90350
50W for the 2*4 PLT-90351

1. DIP switches are located on the drive box. (see Fig.6)
2. Select a wattage and color temperature by sliding switch left or right respectively to the desired value. (see Fig.6A)



Any further questions or interests, pls visit
www.pltsolutions.com

Installation Instruction

Additional Accessories

- Emergency Battery Back-up
 - YH34/YH34A

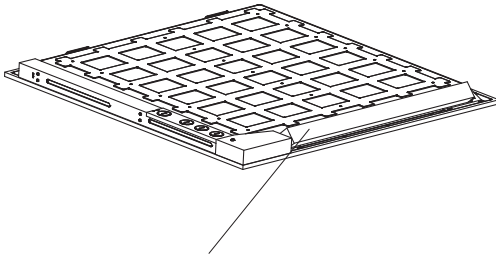

Emergency LED Driver

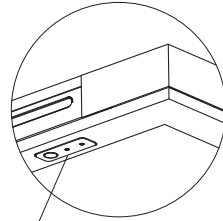

Test switch

LED indicator

- Red stable: charging mode or charging full
- Red off: main power off or discharging mode

Recharge time

-24hours

Operation time

-90 minutes with 1000-1500 lumens output

The fixture can be switched off by connected wall switch. When emergency conditions (main power off), use wall switch to turn on the fixture which will be running in emergency mode.

CAUTION:

- DO NOT USE OUTDOORS.
- DO NOT MOUNT NEAR GAS OR ELECTRONIC HEATERS.
- EQUIPMENT SHOULD BE MOUNTED IN LOCATIONS AND AT HEIGHTS WHERE IT WILL NOT BE SUBJECTED TO TAMPERING BY UNAUTHORIZED PERSONNEL.
- THE USE OF ACCESSORY EQUIPMENT NOT RECOMMENDED BY THE MANUFACTURER MAY CAUSE AN UNSAFE CONDITION.
- DO NOT USE THIS EQUIPMENT FOR OTHER THAN ITS INTENDED USE.

- Use with grounded, UL Listed, damp location rated fixtures and case should be grounded.
- The Emergency LED Driver is intended for ordinary locations and for permanent installation into one or more UL Listed emergency luminaires.



Any further questions or interests,pls visit

www.pltsolutions.com