



## DESCRIPTION

Outlasting and outperforming traditional metal halide fixtures, these LED area lights are ideal for a variety of outdoor applications.

## FEATURES

- Up to 165 LPW ultra-high efficiency delivers superior performance over older HID fixtures
- Type III light distribution projects light outwards with a lateral width of 40 degrees
- Type V light distribution projects light in a circular pattern with the same intensity at all angles
- 0-10V dimming
- Mounting accessories sold separately, see Mounting Accessories sections for full list of compatible mounts

## LISTINGS

- IP65
- UL Listed for wet locations
- IK10
- FCC

## PERFORMANCE

- CRI: >70
- CCT: 4000K, 5000K
- LED L70 Life Hours: ≥100,000 hours
- Light Distribution: Type III, Type V
- Philips Lumileds LEDs

## THERMAL

- -40°F to 113°F (-40°C to 45°C) operating temperature

## ELECTRICAL

- THD: <20%
- Power Factor: >0.95
- Input Voltage: 120-277V, 277-480V
- Dimmable power supply (0-10V)
- Surge Protection: 6kV

## INSTALLATION

- Designed to be mounted with Excel Series and select Grandview Series slip fitters, straight arms, or U brackets (all sold separately), see Mounting Accessories section for full list of compatible products. See installation instructions for more information on how to install these fixtures.

## CONSTRUCTION

- Low profile die-cast aluminum housing
- Durable dark bronze powder coat finish
- Polycarbonate lens

<b>Project name</b>	<b>Type</b>
<b>Catalog number</b>	
<b>Comments</b>	<b>Voltage</b>
<b>Approved by</b>	<b>Date</b>



## WARRANTY

- 5-year limited warranty; see [pltsolutions.com](http://pltsolutions.com) for warranty details

## APPLICATIONS

- Parking Lots
- Automotive Dealerships
- Roadways
- Campuses
- Area Security Lighting
- Airports

# PERFORMANCE SUMMARY

Item #	Family	Watts	Lumens	LPW	CCT	CRI	Dimming	Voltage	Replaces	Light Distribution	DLC #	DLC Level
PLT-13017	Excel Series	300	48,000	160	5000K	>70	0-10V	120-277V	MH1000	Type V	N/A	N/A
PLT-13018	Excel Series	300	45,000	150	5000K	>70	0-10V	120-277V	MH1000	Type III	N/A	N/A
PLT-13019	Excel Series	300	48,000	160	4000K	>70	0-10V	120-277V	MH1000	Type V	N/A	N/A
PLT-13020	Excel Series	300	45,000	150	4000K	>70	0-10V	120-277V	MH1000	Type III	N/A	N/A
PLT-13021	Excel Series	300	48,000	160	5000K	>70	0-10V	277-480V	MH1000	Type V	N/A	N/A
PLT-13022	Excel Series	300	45,000	150	5000K	>70	0-10V	120-277V	MH1000	Type III	N/A	N/A
PLT-13024	Excel Series	220	35,200	160	5000K	>70	0-10V	120-277V	MH1000	Type V	N/A	N/A
PLT-13025	Excel Series	220	33,000	150	5000K	>70	0-10V	120-277V	MH1000	Type III	N/A	N/A
PLT-13026	Excel Series	220	35,200	160	4000K	>70	0-10V	120-277V	MH1000	Type V	N/A	N/A
PLT-13027	Excel Series	220	35,200	160	4000K	>70	0-10V	120-277V	MH1000	Type III	N/A	N/A
PLT-13028	Excel Series	220	35,200	160	5000K	>70	0-10V	277-480V	MH1000	Type V	N/A	N/A
PLT-13029	Excel Series	220	33,000	150	5000K	>70	0-10V	277-480V	MH1000	Type III	N/A	N/A
PLT-13030	Excel Series	150	23,500	155	5000K	>70	0-10V	120-277V	MH400	Type V	N/A	N/A
PLT-13031	Excel Series	150	21,750	145	5000K	>70	0-10V	120-277V	MH400	Type II	N/A	N/A
PLT-13034	Excel Series	150	23,250	155	4000K	>70	0-10V	120-277V	MH400	Type V	N/A	N/A
PLT-13035	Excel Series	150	22,950	153	4000K	>70	0-10V	120-277V	MH400	Type III	N/A	N/A
PLT-13036	Excel Series	150	23,250	155	5000K	>70	0-10V	277-480V	MH400	Type V	N/A	N/A
PLT-13037	Excel Series	100	16,500	165	5000K	>70	0-10V	120-277V	MH250	Type V	N/A	N/A
PLT-13038	Excel Series	100	15,300	153	5000K	>70	0-10V	120-277V	MH250	Type III	N/A	N/A
PLT-13039	Excel Series	100	16,500	165	4000K	>70	0-10V	120-277V	MH250	Type V	N/A	N/A
PLT-13040	Excel Series	100	15,500	155	4000K	>70	0-10V	120-277V	MH250	Type III	N/A	N/A
PLT-13133	Excel Series	150	19,500	130	5000K	>70	0-10V	277-480V	MH400	Type III	N/A	N/A
PLTS-11986	Excel Series	220	28,600	130	5000K	80+	0-10V	277-480V	MH400	Type III	PLTBFA512	5.1 Premium
PLTS-11987	Excel Series	300	39,000	130	5000K	80+	0-10V	277-480V	MH1000	Type III	PLTBF7512	5.1 Premium
PLTS-11988	Excel Series	100	13,000	130	5000K	80+	0-10V	120-277V	MH250	Type III	PLTBF4513	5.1 Premium
PLTS-11970	Excel Series	100	13,500	135	4000K	80+	0-10V	120-277V	MH250	Type V	PLTBF4323	5.1 Premium

## MOUNTING ACCESSORIES (SOLD SEPARATELY)

Item #	Family	Description	Compatible Area Lights
PLT-13003	Excel Series	Adjustable U-bracket for 100W and 150W fixtures	PLT-13133, PLT-13130, PLT-13031, PLT-13034, PLT-13035, PLT-13036, PLT-13037, PLT-13038, PLT-13039, PLT-13040, PLTS-11988, PLTS-11970
PLT-13004		Adjustable U-bracket for 200W & 300W Fixtures	PLT-13017, PLT-13018, PLT-13019, PLT-13020, PLT-13021, PLT-13022, PLT-13024, PLT-13025, PLT-13026, PLT-13027, PLT-13028, PLT-13029, PLTS-11986, PLTS-11987
PLT-13006	Grandview Series	6" Mounting Arm for Square Poles	PLT-13017, PLT-13018, PLT-13019, PLT-13020, PLT-13021, PLT-13133, PLT-13022, PLT-13024, PLT-13025, PLT-13026, PLT-13027, PLT-13028, PLT-13029, PLT-13130, PLT-13031, PLT-13034, PLT-13035, PLT-13036, PLT-13037, PLT-13038, PLT-13039, PLT-13040, PLTS-11986, PLTS-11987, PLTS-11988, PLTS-11970
PLT-13007	Grandview Series	6" Mounting Arm for Square or Round Poles	PLT-13017, PLT-13018, PLT-13019, PLT-13020, PLT-13021, PLT-13133, PLT-13022, PLT-13024, PLT-13025, PLT-13026, PLT-13027, PLT-13028, PLT-13029, PLT-13130, PLT-13031, PLT-13034, PLT-13035, PLT-13036, PLT-13037, PLT-13038, PLT-13039, PLT-13040, PLTS-11986, PLTS-11987, PLTS-11988, PLTS-11970
PLT-13008	Grandview Series	Slipfitter for Tenons up to 2.38" in Diameter	PLT-13017, PLT-13018, PLT-13019, PLT-13020, PLT-13021, PLT-13024, PLT-13133, PLT-13022, PLT-13025, PLT-13026, PLT-13027, PLT-13028, PLT-13029, PLT-13130, PLT-13031, PLT-13034, PLT-13035, PLT-13036, PLT-13037, PLT-13038, PLT-13039, PLT-13040, PLTS-11986, PLTS-11987, PLTS-11988, PLTS-11970
PLTS-11989	Excel Series	Adjustable U-bracket for 100W and 150W fixtures	PLTS-11988, PLTS-11970

## DIMENSIONS

### **PLT-13017, PLT-13018, PLT-13019, PLT-13020**

Length: 23.17"  
 Height: 3.46"  
 Width: 12.55"  
 Weight: 13.1 lbs

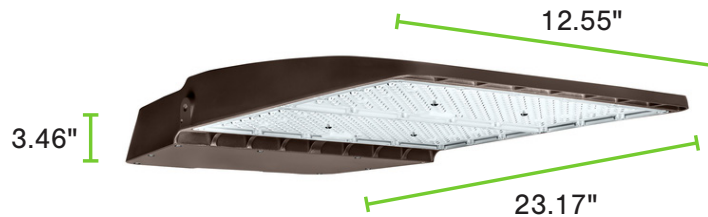

### **PLT-13021, PLT-13022**

Length: 23.17"  
 Height: 3.46"  
 Width: 12.55"  
 Weight: 13.25 lbs

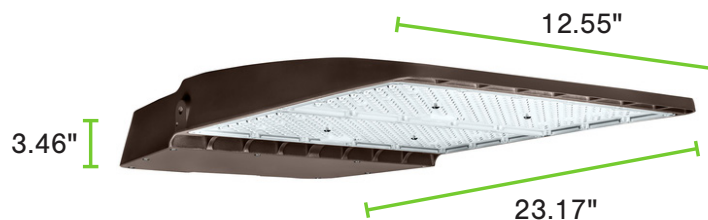

## DIMENSIONS

### **PLT-13024, PLT-13026, PLT-13027**

Length: 23.17"  
Height: 3.46"  
Width: 12.55"  
Weight: 12.83 lbs

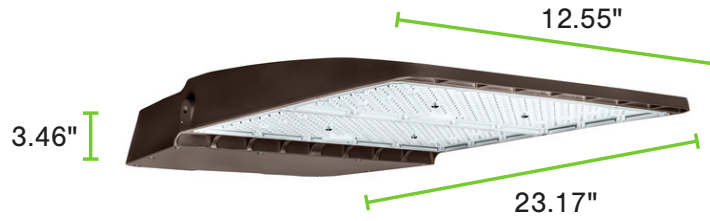

### **PLT-13025**

Length: 23.17"  
Height: 3.46"  
Width: 12.55"  
Weight: 7.85 lbs

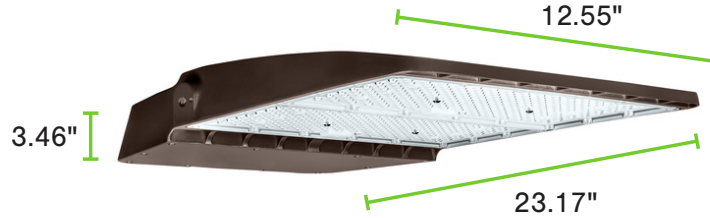

### **PLT-13028, PLT-13029**

Length: 23.17"  
Height: 3.46"  
Width: 12.55"  
Weight: 12.88 lbs

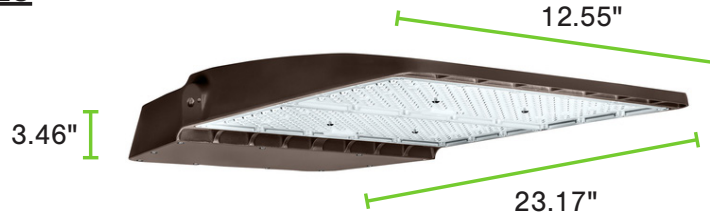

### **PLT-13130, PLT-13031, PLT-13134, PLT-13035**

Length: 13.82"  
Height: 3.03"  
Width: 12.55"  
Weight: 7.85 lbs

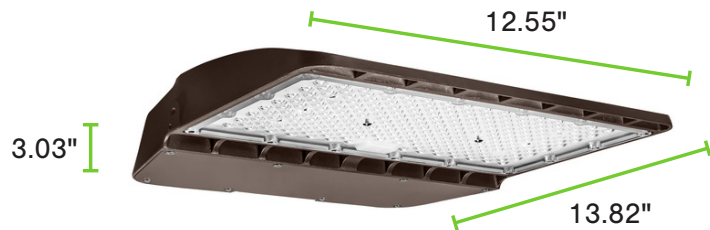

### **PLT-13036**

Length: 13.82"  
Height: 3.03"  
Width: 12.55"  
Weight: 7.94 lbs

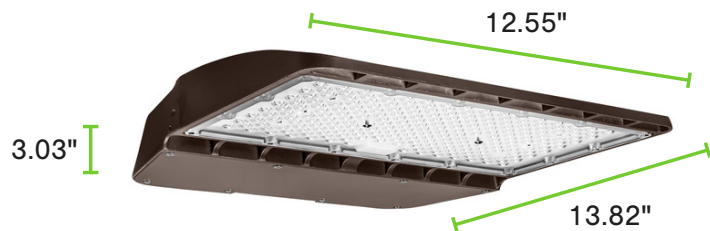

## DIMENSIONS

### **PLT-13037, PLT-13038, PLT-13039, PLT-13040**

Length: 13.82"  
Height: 3.03"  
Width: 12.55"  
Weight: 7.61 lbs

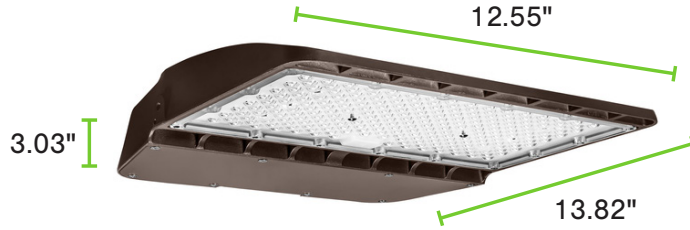

### **PLT-13133**

Length: 13.8"  
Height: 3"  
Width: 12.6"  
Weight: 9.7 lbs

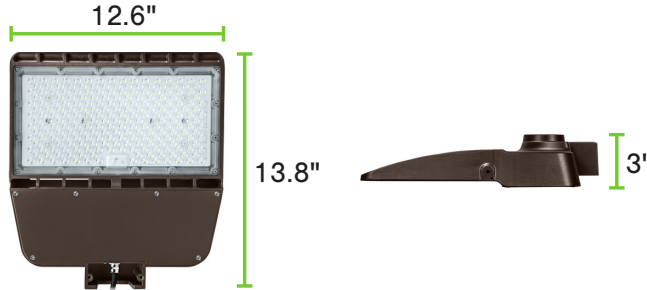

### **PLTS-11986**

Length: 23.2"  
Height: 3.2"  
Width: 12.6"  
Weight: 15.7 lbs

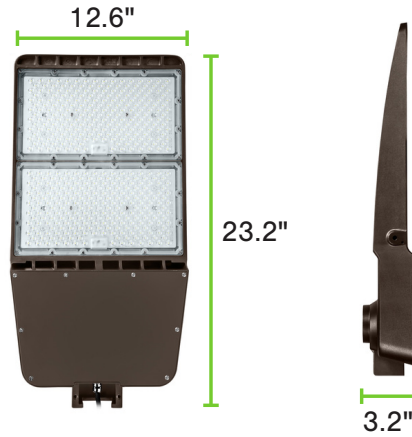

### **PLTS-11987**

Length: 23.2"  
Height: 3.2"  
Width: 12.6"  
Weight: 16.8 lbs

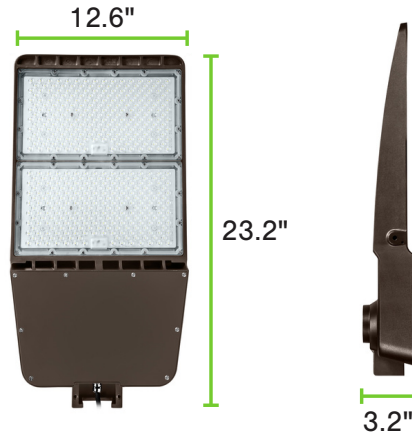

### **PLTS-11970**

Length: 13.8"  
Height: 3"  
Width: 12.6"  
Weight: 8.7 lbs

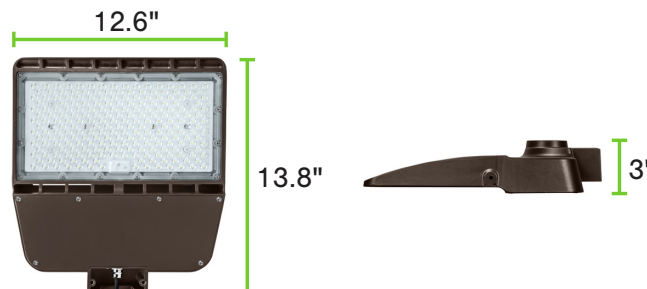

**PLT-13017, PLT-13019, PLT-13021,**  
**PLT-13024, PLT-13026, PLT-13028,**  
**PLT-13030, PLT-13034, PLT-13036,**  
**PLT-13037, PLT-13039**

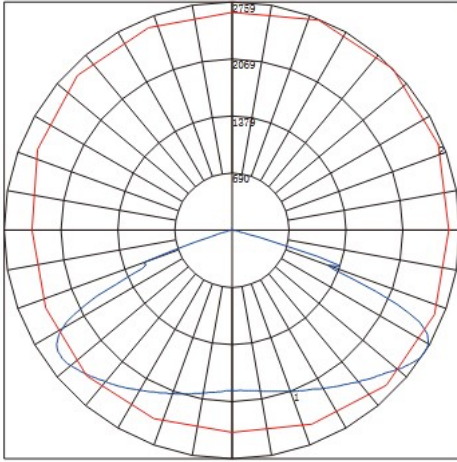

**PLT-13018, PLT-13020, PLT-13022,**  
**PLT-13025, PLT-13027, PLT-13029,**  
**PLT-13031, PLT-13035, PLT-13038,**  
**PLT-13040**

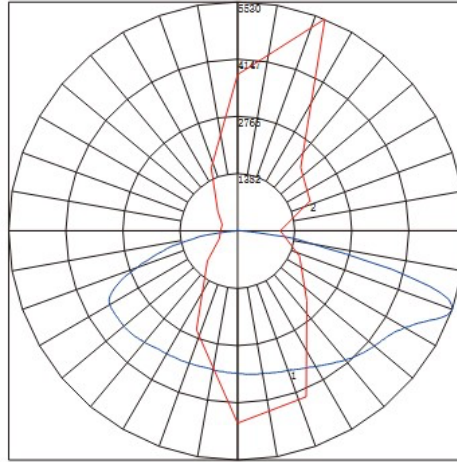

**PLT-13133**

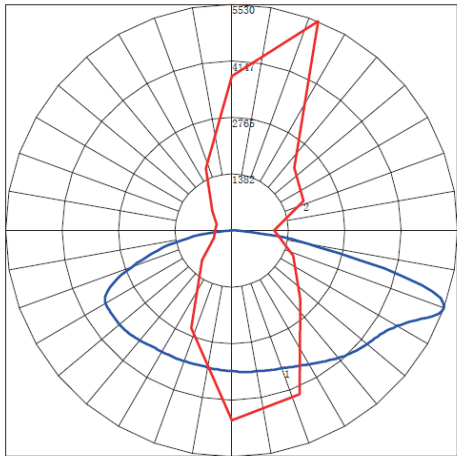

**PLTS-11986**

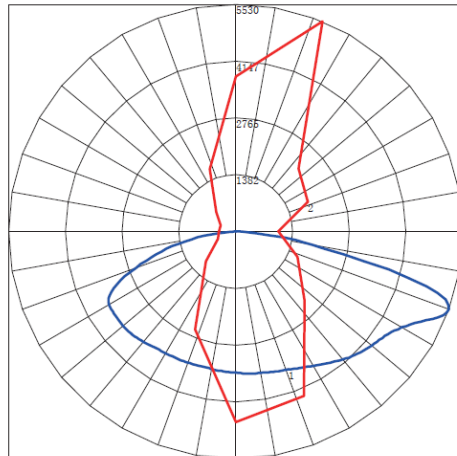

**PLTS-11987**

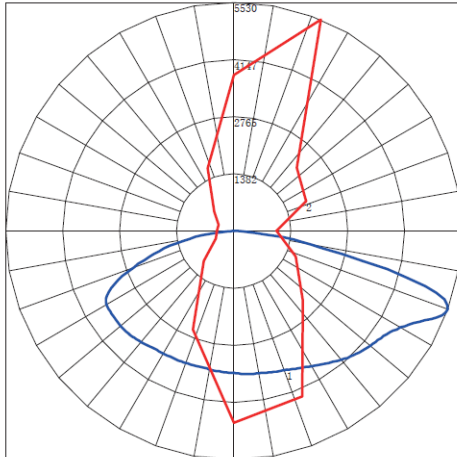

**PLTS-11988**

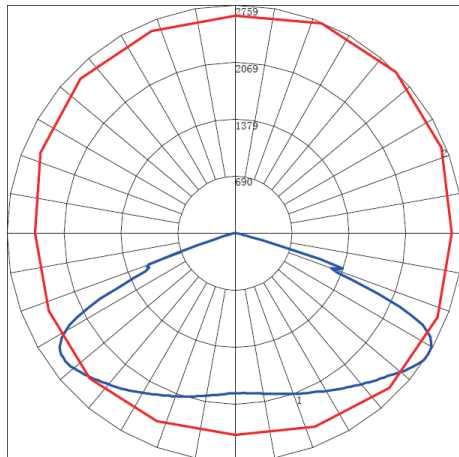

**PLTS-11970**

