

VERSA 2.3"

LED Architectural Linear



VERSA series 2.3" linear pendant lighting is a unique linear series that brings any space to the center stage. These timeless, streamlined forms blend well with contemporary decors and modern workplaces. These linear luminaries is available in 2ft, 4ft and 8ft, simply provide wide, powerful lighting to any atmosphere with continuous runs. It can provide smooth uplight and downlight, allowing for wider spacing between fixtures and better ceiling light uniformity. Unleash lighting design flexibility with VERSA with different shapes and patterns, it adds fun factor into each room. These creations will let you suggest rhythm, communicate meaning and showcase element of life.

Feature

- Wattage adjustable (50%/75%/100%)
- CCT adjustable from 3000K, 3500K, 4000K
- 7 embedded lighting distributions adjusting by dip switch
- Available in diffuser, micro reflector, louver and deep regressed lens
- Individual units or continuous runs
- Custom pattern with optional Line, L, X, T, Y, V, Z joiners

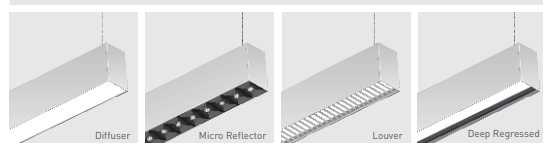

Above are subject to 3500K with 50% up and 50% down lighting distribution. All efficacy is ±5% base on different CCT and lighting distributions. Check the IES file to gain the accurate data .

PERFORMANCE

Lens	Lumen Package*			SKUs
	High	Medium	Low	
Diffuser	1150lm/ft,10w/ft	860lm/ft,7.5w/ft	575lm/ft, 5w/ft	<i>Special Order. Call 1-800-624-4488</i>
Louver	900lm/ft,10w/ft	675lm/ft,7.5w/ft	450lm/ft, 5w/ft	<i>Special Order. Call 1-800-624-4488</i>
Micro Reflector	1150lm/ft,10w/ft	860lm/ft,7.5w/ft	575lm/ft, 5w/ft	PLT-90365, PLT-90366, PLT-90367, PLT-90368
Deep Regressed	950lm/ft,10w/ft	710lm/ft,7.5w/ft	475lm/ft, 5w/ft	<i>Special Order. Call 1-800-624-4488</i>

Specifications and dimensions subject to change without notice. Please refer to product specification sheet for the most updated technical data. www.1000bulbs.com

*See Selectable Table on pages 4 & 5 for full breakdown of lumens and LPWs.

VERSA 2.3"

Pendant - LED Architectural Linear

PRODUCT PERFORMANCE

► Optics

It offers a selection of professional lens such as diffuser, louver, micro reflector and deep regressed lens to meet your different requires.

► Finish

- Extruded aluminum housing.
- Powder coat white and black finish or custom.

► Electrical

LED Driver	It is powered by Class 2 high efficiency LED driver, with a standard 1-10V dimming which continuous dims to 10% that works with many types of controls. Tested Dimmers: Lutron® Diva-Dvtv, Leviton® IP-710-DL.
THD	<20%
Power Factor	>0.9
Input Voltage	Standard electronic drivers are cULus recognized and available for 110-277V or 110-347VAC

► Mounting

- Pendant-Dry ceiling or T-Grid ceiling compatible. Cable lengths of 5ft is standard, 12ft or others are available
- Individual or continuous run, up to 40ft in 120VAC, 100ft in 277VAC
- Custom Pattern with optional Line, L, X, T, V, Y, Z joiners.

► LED System

CRI	Minimum 80 color rendering index
CCT	The choice of 3000K, 3500K, 4000K color temperature with a great color consistency, or CCT adjustable from 3000K,3500K and 4000K.
LED	Life Minimum 50,000h with 87.8% of lumen maintenance in 25°C ambient temperature, in compliance with IES LM-80 testing measurements.

► Approvals

- cULus listed for damp locations
- 5 years limited warranty

► Optional Function

Emergency Option



Optional high voltage emergency LED driver can be provided. When AC power fails, it immediately switches to the emergency mode, operating for lighting up to 120 minutes. When AC power is restored, it automatically returns to the charging mode which meets critical life-safety lighting requirements. For more info or spec sheet, please call 1-800-624-4488.

Sensor Option



We can provide a factory-installed integrated sensor system for multi-level control based on motion and/or daylight contribution with BI-level & daylight harvest microwave sensor. For more info or spec sheet, please call 1-800-624-4488.

PRODUCT ORDERING GUIDE

PLT-90365 - 20/30/40W, White Finish, 4'
PLT-90366 - 20/30/40W, Black Finish, 4'
PLT-90367 - 40/60/80W, White Finish, 8'
PLT-90368 - 40/60/80W, Black Finish, 8'

1. Base Model

ZE

2. Length

2** 2 feet 4 4 feet 8 8 feet

3. Width

2 2.3 inch

4. Driver

I Internal

5. CCT

30** 3000K 35 3500K 40** 4000K
 TW** CCT Adjustable (3000K,3500K,4000K)

6. Light Distribution

A Following options available by dip switch
100% Uplight 10% down, 90% up 30% down, 70% up
50% down, 50% up 70% down, 30% up 90% down, 10% up
100% Downlight

7. Optics Options

D Diffuser **NPS-00057*** R Micro Reflector
 L Louver **NPS-00058*** T Deep Regressed **NPS-00059***

INSTALLATION ORDERING GUIDE

Ceiling Type (see page 2 for part numbers)

Dry Wall (Mount to J-box)
 Drop Ceiling Clips (Suitable for 9/16" and 15/16" Flat Ceiling)
 Drop Ceiling Clips (Suitable for 9/16" Slot Ceiling)
 Drop Ceiling Clips (Suitable for 15/16" Slot Ceiling)

Canopy

1.6" Round 4.5" Round (Designed for power cable)
 1.6" Square **NPS-00060*** 4.5" Square (Designed for power cable) **NPS-00061***

Joiner (see page 2 for part numbers)

"—" pattern "T" pattern
 "X" pattern "Y" pattern
 "L" pattern "V" pattern
 "Z" pattern

Optional Accessory

Rolling Diffuser (42') **NPS-00062***
 Emergency LED Driver **NPS-00063***
 Sensor **NPS-00064***

VERSA 2.3"

Pendant - LED Architectural Linear



DIMENSIONS

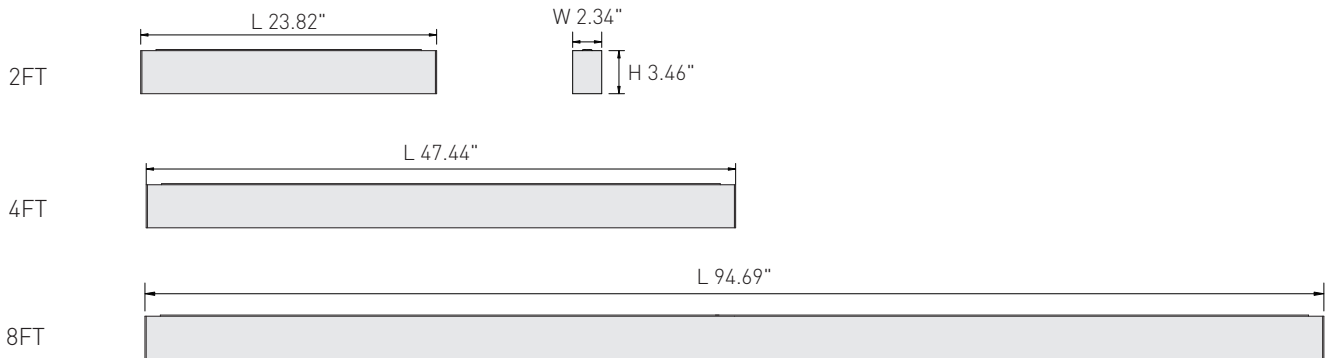

MOUNTING

Dry Ceiling / Off Grid

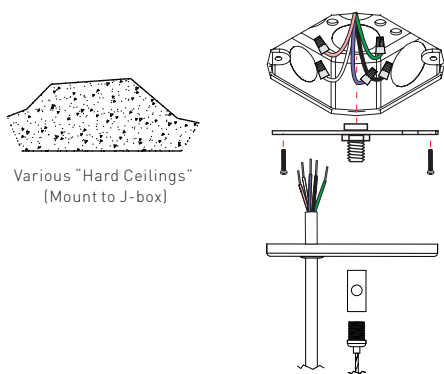

Drop Ceiling / On Grid

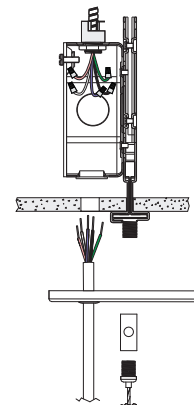
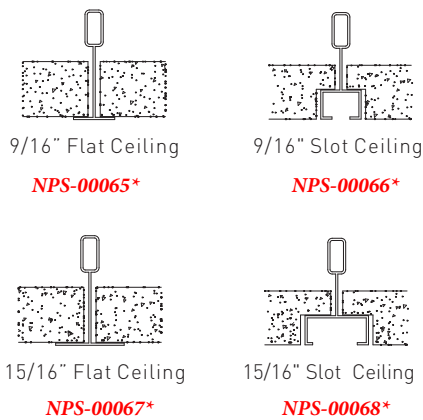

Individual

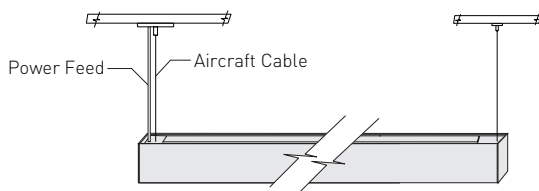

Additional Accessories:

PLT-90303 - 12' Power Cord w/ White Finish

PLT-90302 - 12' Power Cord w/ Black Finish

** Special order item. Please call 1-800-624-4488 for more information.*

Continuous Run

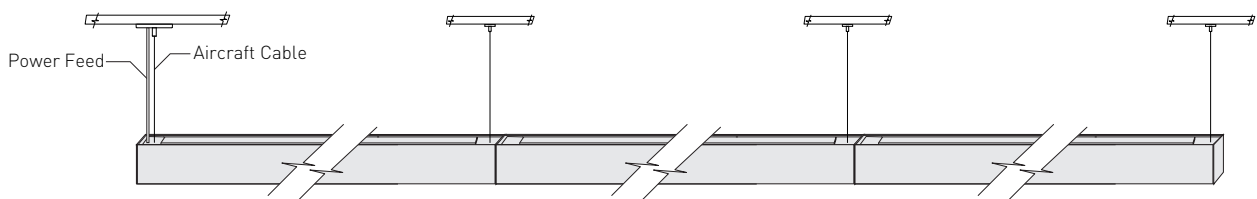

120VAC: Connections up to 40ft.

277VAC: Connections up to 100ft.

VERSA 2.3"

Pendant - LED Architectural Linear



SELECTABLE TABLE

SKU	Wattage	CCT	Lumens	LPW	Distribution
PLT-90365	20	3500K	2534	127	100% Up
			2622	131	90% Up/10% Down
			2615	131	70% Up/30% Down
			2517	126	50% Up/50% Down
			2430	122	30% Up/70% Down
			2373	119	10% Up/90% Down
			2119	106	100% Down
	30	3500K	3701	123	100% Up
			3790	126	90% Up/10% Down
			3719	124	70% Up/30% Down
			3557	119	50% Up/50% Down
			3387	113	30% Up/70% Down
			3176	106	10% Up/90% Down
			2975	99	100% Down
	40	3500K	4840	121	100% Up
			4916	123	90% Up/10% Down
			4782	120	70% Up/30% Down
			4550	114	50% Up/50% Down
			4305	108	30% Up/70% Down
			3958	99	10% Up/90% Down
			3711	93	100% Down

SKU	Wattage	CCT	Lumens	LPW	Distribution
PLT-90366	20	3500K	2366	118	100% Up
			2495	125	90% Up/10% Down
			2575	129	70% Up/30% Down
			2540	127	50% Up/50% Down
			2577	129	30% Up/70% Down
			2476	124	10% Up/90% Down
			2278	114	100% Down
	30	3500K	3467	116	100% Up
			3623	121	90% Up/10% Down
			3645	122	70% Up/30% Down
			3583	120	50% Up/50% Down
			3486	116	30% Up/70% Down
			3331	111	10% Up/90% Down
			3180	106	100% Down
	40	3500K	4522	113	100% Up
			4664	117	90% Up/10% Down
			4668	117	70% Up/30% Down
			4572	114	50% Up/50% Down
			4407	110	30% Up/70% Down
			4151	104	10% Up/90% Down
			3970	99	100% Down

VERSA 2.3"

Pendant - LED Architectural Linear



SELECTABLE TABLE

SKU	Wattage	CCT	Lumens	LPW	Distribution
PLT-90367	40	3500K	5068	127	100% Up
			5244	131	90% Up/10% Down
			5230	131	70% Up/30% Down
			5034	126	50% Up/50% Down
			4859	121	30% Up/70% Down
			4745	119	10% Up/90% Down
			4237	106	100% Down
	60	3500K	7402	123	100% Up
			7580	126	90% Up/10% Down
			7438	124	70% Up/30% Down
			7114	119	50% Up/50% Down
			6774	113	30% Up/70% Down
			6352	106	10% Up/90% Down
			5951	99	100% Down
	80	3500K	9680	121	100% Up
			9831	123	90% Up/10% Down
			9564	120	70% Up/30% Down
			9099	114	50% Up/50% Down
			8609	108	30% Up/70% Down
			7915	99	10% Up/90% Down
			7422	93	100% Down

SKU	Wattage	CCT	Lumens	LPW	Distribution
PLT-90368	40	3500K	4733	118	100% Up
			4989	125	90% Up/10% Down
			5150	129	70% Up/30% Down
			5079	127	50% Up/50% Down
			5154	129	30% Up/70% Down
			4952	124	10% Up/90% Down
			4556	114	100% Down
	60	3500K	6933	116	100% Up
			7243	121	90% Up/10% Down
			7290	122	70% Up/30% Down
			7167	120	50% Up/50% Down
			6972	116	30% Up/70% Down
			6662	111	10% Up/90% Down
			6359	106	100% Down
	80	3500K	9044	113	100% Up
			9328	117	90% Up/10% Down
			9336	117	70% Up/30% Down
			9144	114	50% Up/50% Down
			8814	110	30% Up/70% Down
			8301	104	10% Up/90% Down
			7940	99	100% Down

Standard Line Runs In 120V

Luminaire Run Length (ft)	Run Configuration	Line Joiner	5' Power Cable	5' Aircraft Cable	Canopy
2	2'	-	1	2	2
4	4'	-	1	2	2
6	4'+2'	1	1	3	3
8	8'	-	1	2	2
10	8'+2'	1	1	3	3
12	8'+4'	1	1	3	3
14	8'+4'+2'	2	1	4	4
16	8'+8'	1	1	3	3
18	8'+8'+2'	2	1	4	4
20	8'+8'+4'	2	1	4	4
22	8'+8'+4'+2'	3	1	5	5
24	8'+8'+8'	2	1	4	4
26	8'+8'+8'+2'	3	1	5	5
28	8'+8'+8'+4'	3	1	5	5
30	8'+8'+8'+4'+2'	4	1	6	6
32	8'+8'+8'+8'	3	1	5	5
34	8'+8'+8'+8'+2'	4	1	6	6
36	8'+8'+8'+8'+4'	4	1	6	6
38	8'+8'+8'+8'+4'+2'	5	1	7	7
40	8'+8'+8'+8'+8'	4	1	6	6
42	8'+8'+8'+8'+8'+2'	5	2	7	7
44	8'+8'+8'+8'+8'+4'	5	2	7	7
46	8'+8'+8'+8'+8'+4'+2'	6	2	8	8
48	8'+8'+8'+8'+8'+8'	5	2	7	7

Note: 4.5" canopy is designed for power cable

Custom Pattern With Joiners

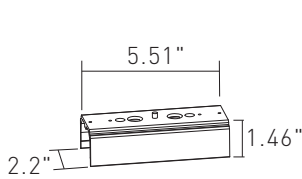

"—" pattern
PLT-90304

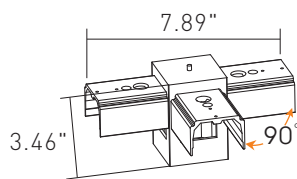

"T" pattern
NPS-00069*

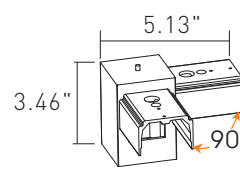

"L" pattern
NPS-00070*

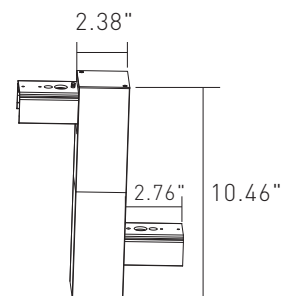

"Z" pattern
NPS-00074*

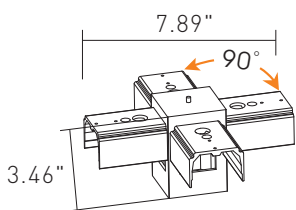

"X" pattern
NPS-00071*

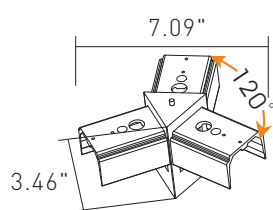

"Y" pattern
NPS-00072*

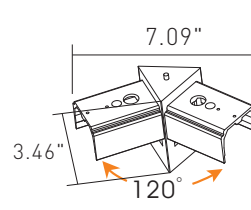

"V" pattern
NPS-00073*

* Special order item. Please call 1-800-624-4488 for more information.

DISTRIBUTION DIAGRAM

4' / Diffuser/50% Up,50% Down/ 4000K

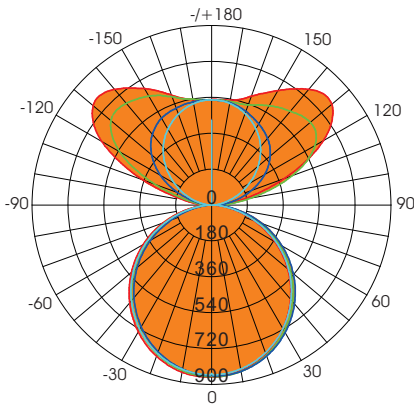

Test Number: ZE-42-I40AD
 Lumens: 4739.1 Lm
 Watts: 40 W
 LPW: 118.48 Lm/W
 CCT: 4000K

UNIT: cd
 — C0/180, 360°
 — C30/270, 360°
 — C60/240, 360°
 — C90/270, 360°

Zonal Flux Diagram

τ	C0	C45	C90	C135	C180
5	857.7	858.1	847.3	841.0	861.4
10	844.1	849.1	835.1	821.8	851.1
15	822.1	831.6	815.6	795.4	833.5
20	792.8	807.2	788.8	762.5	807.4
25	757.1	775.5	755.5	723.0	774.6
30	716.2	737.2	715.9	677.7	735.6
35	667.9	693.4	670.2	627.5	690.3
40	616.1	644.0	619.9	572.8	639.9
45	559.4	589.1	564.3	513.7	585.0
50	499.2	530.9	505.0	451.3	525.8
55	434.1	468.3	441.5	385.1	462.7
60	365.3	402.1	374.7	315.6	395.8
65	295.4	332.9	305.0	244.5	326.8
70	224.4	260.6	232.0	174.7	254.3
75	154.3	189.1	161.3	108.6	184.1
80	90.07	120.5	95.53	51.77	117.0
85	36.95	60.98	41.01	10.68	58.12
90	39.69	49.44	5.334	21.91	41.89
95	85.06	88.27	21.25	52.16	75.79
100	151.2	163.7	51.22	102.9	136.5
105	253.3	249.8	89.41	186.2	230.4
110	384.4	328.2	131.1	278.8	362.9
115	522.2	393.5	175.2	367.8	502.4
120	647.4	443.0	219.3	441.8	634.5
125	736.9	476.4	263.0	496.2	724.5
130	787.6	497.4	305.2	530.7	775.5
135	790.8	509.9	345.3	550.9	783.9
140	758.4	518.4	382.3	561.8	757.7
145	711.4	519.9	415.5	567.2	716.9
150	663.4	517.6	443.7	564.1	675.3
155	619.4	514.2	468.7	554.3	630.8
160	581.3	514.0	489.8	540.6	586.6
165	549.4	519.6	506.9	535.1	554.4
170	534.3	524.9	518.7	530.1	537.2
175	531.2	528.0	526.1	528.6	529.6
180	529.9	529.8	529.8	529.8	529.9
DEG	LUMINOUS INTENSITY:cd				

Zonal Lumens

τ	φ total
0-5	20.42
5-10	80.98
10-15	179.6
15-20	312.7
20-25	475.8
25-30	663.4
30-35	869.1
35-40	1086
40-45	1307
45-50	1525
50-55	1733
55-60	1924
60-65	2092
65-70	2230
70-75	2336
75-80	2408
80-85	2448
85-90	2466
90-95	2489
95-100	2533
100-105	2611
105-110	2730
110-115	2888
115-120	3081
120-125	3295
125-130	3517
130-135	3735
135-140	3940
140-145	4125
145-150	4287
150-155	4426
155-160	4539
160-165	4626
165-170	4689
170-175	4726
175-180	4739
	UNIT: lm

Luminance cd/(m2)

G(DEG)	C0/180	C90/270
85	5888	6535
80	7204	7641
75	8283	8654
70	9112	9422
65	9708	10024
60	10148	10409
55	10512	10690
50	10787	10912
45	10988	11085

VERSA 2.3"

LED Architectural Linear

DISTRIBUTION DIAGRAM

4'/Louver/50% Up,50% Down/ 4000K

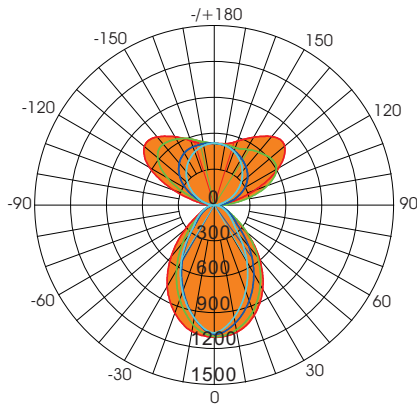

Test Number: ZE-42-140AL
 Lumens: 3865.5 Lm
 Watts: 40 W
 LPW: 96.64 Lm/W
 CCT: 4000K

UNIT: cd
 — C0/180, 324.8°
 — C30/270, 314.8°
 — C60/240, 65.6°
 — C90/270, 61.7°

Zonal Flux Diagram

τ	C0	C45	C90	C135	C180
5	1100	1077	1028	1015	1096
10	1080	1035	954.1	927.2	1072
15	1041	977.1	866.4	828.8	1028
20	979.0	906.2	768.3	723.1	961.9
25	903.0	823.8	661.9	612.2	881.6
30	812.0	730.3	548.8	499.4	787.4
35	706.6	628.1	432.8	390.0	679.1
40	591.3	522.4	316.4	290.5	560.6
45	471.1	417.4	235.2	206.1	439.0
50	351.7	316.7	194.1	152.0	319.5
55	244.0	231.3	158.3	115.4	215.3
60	160.0	176.7	126.5	85.60	138.9
65	117.8	138.1	98.45	60.39	105.0
70	83.27	105.6	73.47	38.44	73.07
75	55.29	77.53	51.06	19.18	46.75
80	32.44	53.30	31.05	2.405	25.50
85	13.97	49.71	13.08	0.4994	7.709
90	29.54	66.04	1.446	0.4677	28.35
95	70.36	110.9	14.68	27.90	68.82
100	133.0	190.9	43.89	68.63	129.1
105	228.5	270.2	80.50	137.4	223.0
110	355.3	337.7	121.1	230.3	353.8
115	492.0	391.6	164.4	234.5	492.5
120	619.5	430.1	208.1	409.1	623.0
125	713.4	455.4	251.6	474.8	712.6
130	768.4	471.2	292.9	520.3	762.4
135	777.3	482.8	332.0	546.0	769.7
140	748.7	488.8	368.7	559.9	743.5
145	702.6	489.1	402.4	567.3	703.2
150	654.4	489.0	431.7	567.4	661.0
155	609.5	490.4	456.6	557.6	615.5
160	570.4	497.4	477.9	544.6	571.4
165	537.7	505.0	495.6	530.6	539.5
170	521.3	510.4	508.1	524.3	523.3
175	517.3	513.0	515.4	517.9	516.2
180	516.7	516.6	516.5	516.6	516.7
DEG	LUMINOUS INTENSITY:cd				

Zonal Lumens

τ	φ total
0-5	25.57
5-10	99.25
10-15	214.1
15-20	361.0
20-25	529.2
25-30	707.3
30-35	883.4
35-40	1047
40-45	1189
45-50	1308
50-55	1405
55-60	1483
60-65	1543
65-70	1590
70-75	1624
75-80	1647
80-85	1660
85-90	1672
90-95	1692
95-100	1734
100-105	1808
105-110	1919
110-115	2069
115-120	2252
120-125	2457
125-130	2672
130-135	2883
135-140	3082
140-145	3263
145-150	3422
150-155	3558
155-160	3669
160-165	3755
165-170	3816
170-175	3853
175-180	3866
	UNIT: lm

Luminance cd/(m2)

G(DEG)	C0/180	C90/270
85	2227	2085
80	2595	2483
75	2967	2740
70	3381	2983
65	3871	3236
60	4444	3513
55	5907	3834
50	7599	4195
45	9253	4620

VERSA 2.3"

LED Architectural Linear

DISTRIBUTION DIAGRAM

4'/Micro Reflector/50% Up,50% Down/ 4000K

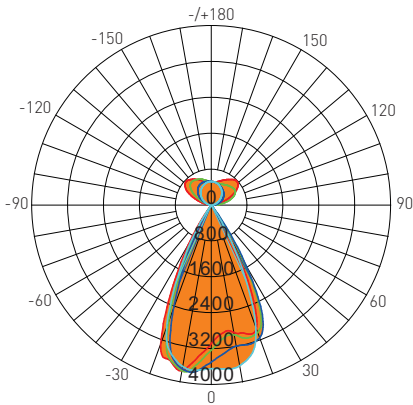

AVERAGE BEAM ANGLE(50%): 51.1°

Test Number: ZE-42-140AR
 Lumens: 4530.0 Lm
 Watts: 40 W
 LPW: 113.25 Lm/W
 CCT: 4000K

UNIT: cd
 — C0/180, 51.8°
 — C30/270, 51.9°
 — C60/240, 51.1°
 — C90/270, 49.5°

Zonal Flux Diagram

τ	C0	C45	C90	C135	C180
5	2868	3126	3668	3715	3397
10	2880	3036	3634	3615	3745
15	2965	3158	3455	2948	3584
20	2939	3141	2911	1757	3294
25	2099	2754	1812	787.4	2093
30	819.2	1675	767.6	84.95	1038
35	57.67	519.7	112.1	5.340	215.8
40	5.200	38.70	6.196	3.696	5.573
45	3.849	4.987	2.988	2.833	3.959
50	2.820	3.517	1.928	1.993	3.010
55	2.048	2.444	1.189	1.486	2.168
60	1.700	1.590	0.8656	1.277	1.783
65	1.470	1.073	0.7377	1.168	1.502
70	1.244	0.8401	0.6042	0.9728	1.231
75	0.9286	0.6696	0.5020	0.8287	0.9745
80	0.6716	0.5905	0.3831	0.7114	0.7084
85	0.5373	29.27	0.2523	0.4937	0.5233
90	30.98	71.66	0.2141	0.0995	29.17
95	75.71	141.9	15.05	24.16	67.03
100	142.1	225.0	44.13	62.52	127.1
105	242.7	301.3	80.91	126.9	220.4
110	372.9	363.9	121.7	217.7	351.7
115	510.1	410.7	165.2	310.7	490.8
120	635.7	442.3	209.3	395.6	622.1
125	724.8	462.4	252.9	463.4	710.8
130	775.0	475.8	294.3	511.7	761.3
135	779.1	483.6	333.9	540.5	769.3
140	747.9	487.4	371.4	557.4	744.0
145	702.3	487.4	407.0	568.1	704.9
150	655.7	488.6	438.3	571.1	664.9
155	612.7	494.3	464.0	564.6	620.9
160	575.3	503.6	486.8	554.1	577.9
165	544.1	512.1	505.8	540.0	547.0
170	529.8	517.2	519.4	534.1	531.5
175	527.0	523.3	527.4	527.4	525.0
180	526.1	525.7	525.2	525.2	526.1
DEG	LUMINOUS INTENSITY:cd				

Zonal Lumens

τ	φ total
0-5	82.46
5-10	328.5
10-15	726.1
15-20	1229
20-25	1728
25-30	2096
30-35	2265
35-40	2302
40-45	2306
45-50	2307
50-55	2308
55-60	2309
60-65	2310
65-70	2310
70-75	2311
75-80	2311
80-85	2313
85-90	2320
90-95	2342
95-100	2386
100-105	2463
105-110	2576
110-115	2727
115-120	2909
120-125	3113
125-130	3327
130-135	3538
135-140	3737
140-145	3919
145-150	4079
150-155	4216
155-160	4329
160-165	4417
165-170	4480
170-175	4517
175-180	4530
	UNIT: lm

Luminance cd/(m2)

G(DEG)	C0/180	C90/270
85	86	40
80	54	31
75	50	27
70	50	25
65	48	24
60	47	24
55	50	29
50	61	42
45	76	59

VERSA 2.3"

LED Architectural Linear

DISTRIBUTION DIAGRAM

4'/Deep Regressed/50% Up,50% Down/ 4000K

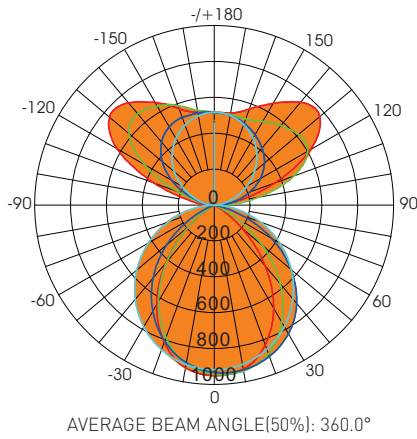

Test Number: ZE-42-140AT
 Lumens: 4070.6 Lm
 Watts: 40 W
 LPW: 101.77 Lm/W
 CCT: 4000K

UNIT: cd
 — C0/180, 360°
 — C30/270,360°
 — C60/240, 360°
 — C90/270, 360°

Zonal Flux Diagram

τ	C0	C45	C90	C135	C180
5	946.0	943.5	913.4	885.0	943.1
10	928.1	938.5	901.8	838.4	921.2
15	891.1	924.5	882.1	780.3	879.6
20	829.8	899.4	855.9	712.6	814.6
25	753.7	861.8	822.4	634.8	735.7
30	663.4	806.8	781.9	546.8	643.6
35	558.1	738.1	734.7	449.6	536.2
40	442.7	657.8	682.4	347.7	418.9
45	322.4	567.3	623.8	243.4	299.6
50	204.9	466.2	560.3	143.4	181.6
55	101.4	356.7	492.9	60.86	84.70
60	27.77	244.0	420.8	10.84	16.86
65	4.112	135.5	345.9	1.668	4.051
70	2.630	47.83	268.2	1.816	2.600
75	1.706	3.690	190.8	1.167	1.677
80	1.065	1.703	117.4	0.7295	1.033
85	0.7453	18.53	49.22	0.4487	0.6440
90	29.42	53.07	1.509	0.3989	28.29
95	70.27	110.8	14.82	27.83	68.73
100	132.9	190.9	44.10	68.59	129.0
105	228.4	270.2	80.81	137.5	222.8
110	355.1	337.7	121.5	230.3	353.6
115	491.8	391.5	164.9	324.7	492.3
120	619.3	430.1	208.7	409.3	622.8
125	713.2	455.4	252.3	475.1	712.4
130	768.2	471.2	293.6	520.7	762.1
135	777.1	482.9	332.7	546.4	769.5
140	748.5	488.9	369.4	560.2	743.3
145	702.4	489.3	403.0	567.7	703.0
150	654.2	489.1	432.2	567.7	660.9
155	609.3	490.4	457.0	557.9	615.3
160	570.3	497.3	478.0	544.8	571.3
165	537.6	504.9	495.7	530.8	539.4
170	521.2	510.3	508.1	524.4	523.2
175	517.2	512.8	515.3	518.0	516.1
180	516.6	516.4	516.4	516.4	516.6
DEG	LUMINOUS INTENSITY:cd				

Zonal Lumens

τ	φ total
0-5	22.14
5-10	87.59
10-15	193.3
15-20	334.1
20-25	503.1
25-30	691.8
30-35	890.3
35-40	1088
40-45	1275
45-50	1441
50-55	1579
55-60	1686
60-65	1763
65-70	1815
70-75	1846
75-80	1862
80-85	1868
85-90	1875
90-95	1894
95-100	1936
100-105	2010
105-110	2122
110-115	2272
115-120	2455
120-125	2661
125-130	2876
130-135	3087
135-140	3287
140-145	3468
145-150	3627
150-155	3763
155-160	3874
160-165	3960
165-170	4021
170-175	4058
175-180	4071
	UNIT: lm

Luminance cd/(m2)

G(DEG)	C0/180	C90/270
85	119	7843
80	85	9390
75	92	10237
70	107	10891
65	135	11369
60	771	11690
55	2455	11935
50	4427	12107
45	6332	12253