

**WARNING**

- To reduce the risk of fire and overheating, make sure all connections are tight.

**CAUTION**

- Do not install in wet locations. For dry and damp use only.
- Do not cover the fixture with heat insulation gaskets or similar materials.
- The maximum connection of each input line is
  - 40 ft. at 120VAC
  - 80 ft. at 230VAC
  - 100 ft. at 277VAC

**Drywall Ceiling**

**Power Feed**

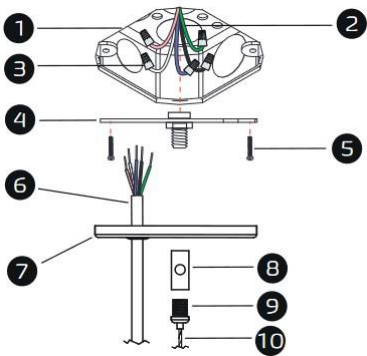

**Non Power Suspension**

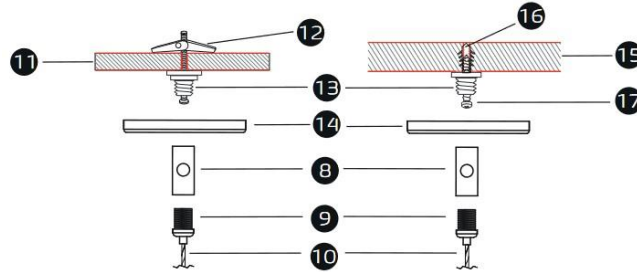

**Parts List**

1. 4" Octagonal Junction Box (by others)
2. Power Cord (by others)
3. Wire Nut
4. Junction Box Crossbar
5. Screw PM4\*22
6. Power Cord
7. 4" Power Canopy Kit
8. Cable Holder
9. Strain Relief Thread Nut
10. Aircraft Cable
11. Drywall Ceiling (by others)
12. Butterfly Drywall anchor
13. Crimp Stud
14. 2" Canopy
15. Solid Ceiling (by others)
16. Anchor
17. Screw PA4\*30

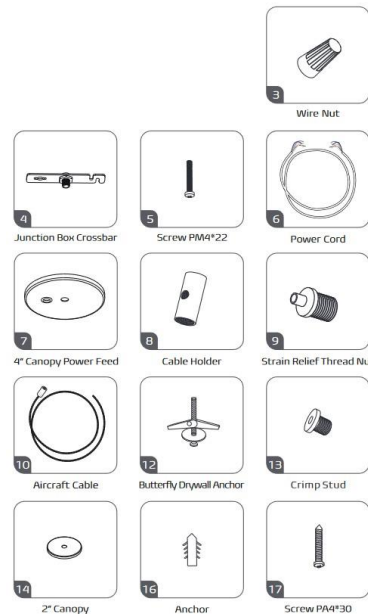

## Installation Instructions

### Pre-Installation – Assemble the Power Cord

1. Take off the end cap. Insert the cord holder into the power cord location as shown. (Figure 1)
2. Take off LED module and thread the power cord into the cord holder as shown. (Figure 2)
3. Wiring must connect connectors with corresponding colors as shown. (Figure 3)
4. Connect power cord with holder nut and reattach the module and end cap. (Figure 4)

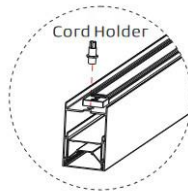

Figure 1

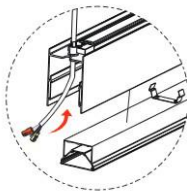

Figure 2

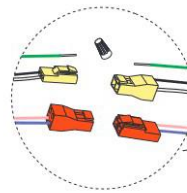

Figure 3

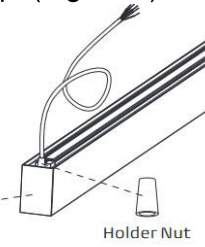
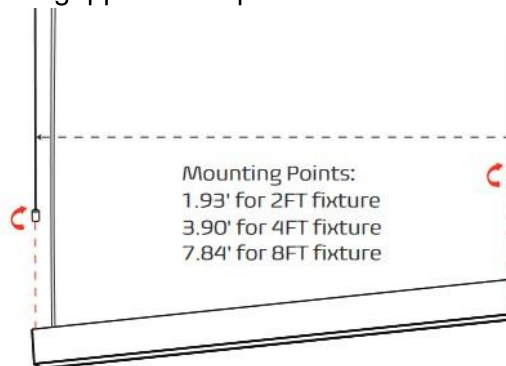

Figure 4

### Installation

1. Hang the Luminaire
  - Screw both bottom parts of aircraft cables clockwise and secure them on the top of the housing.
  - NOTE: The luminaire can be raised by pulling the cable through the gripper and can be lowered by depressing the top cylinder on the gripper which pulls the luminaire down.



2. Complete

- Use the cable tie to secure it against the aircraft cable.

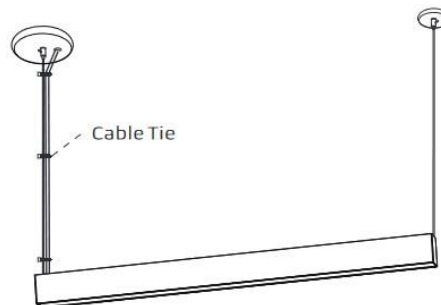

## Connecting Multiple Luminaries Together (Optional)

### Joiner

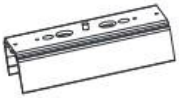

"—" Joiner

### Before Connecting – Disassemble Luminaries

- Start of run (SoR)
  - Remove the end cap of non-powered end and take the LED module out.

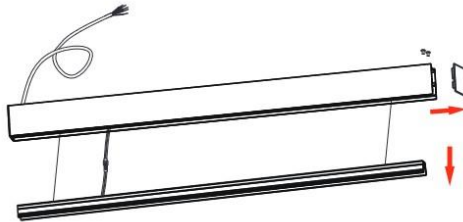

- Middle of run (MoR)
  - Remove both end caps and take the LED module out.

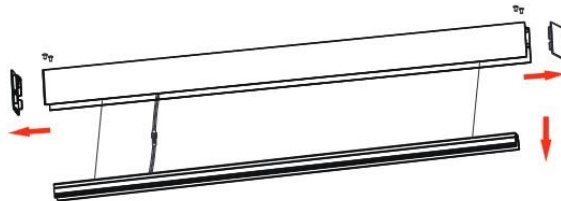

- End of run (EoR)
  - Remove the end cap of non-powered end and take the LED module out.

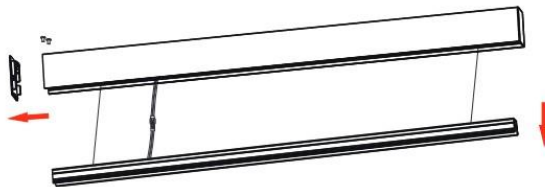

**Connecting Fixtures**

1. Install joiners

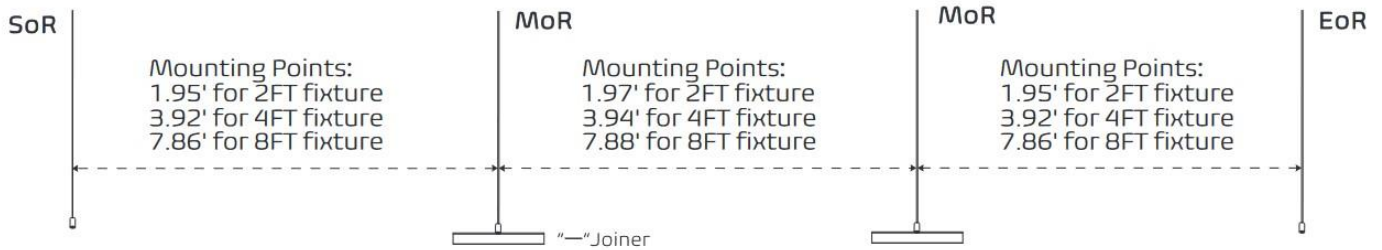

Screw the joiner “—” to the MoR aircraft cable in turn.

2. Hang luminaire and wiring – SoR

- a. Adjust the height of the luminaire. The Luminaire can be raised by pulling the cable through the gripper and can be lowered by depressing the top cylinder on the gripper which pulls the luminaire down.
- b. Insert the joiner “—” into the luminaire from one side and fix with screws.
- c. Screw both bottom parts of the aircraft cables clockwise and secure them on the top of the housing.

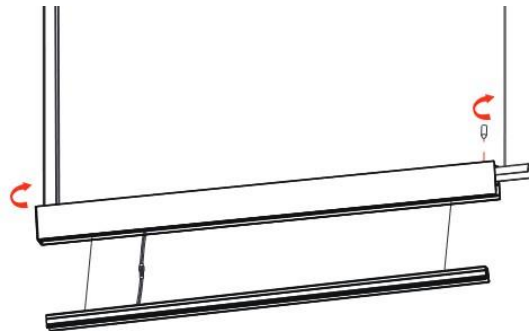

3. Repeat hang and join steps – MoR to EoR

- a. Zip tie the power cord and aircraft suspension cable with the cable tie.
- b. Connect the quick connectors.
- c. Insert all the LED modules into the housing from SoR to EoR.

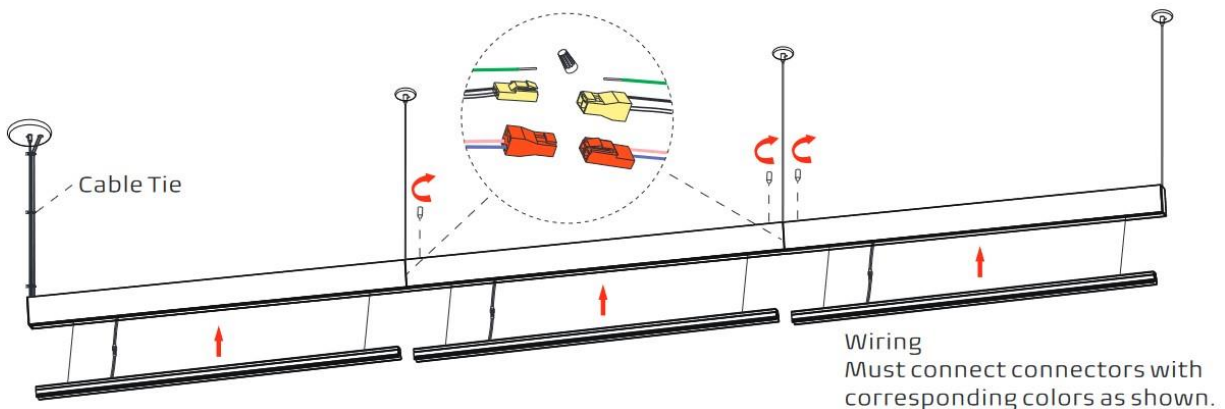

4. Complete

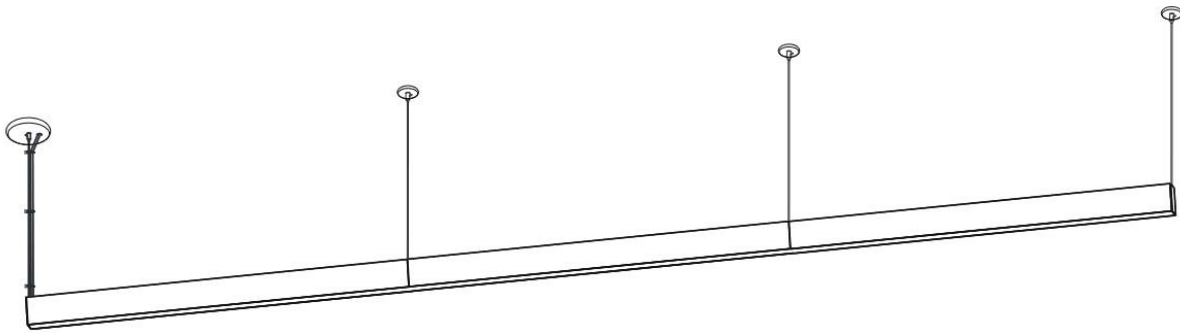

**Wiring Diagram**

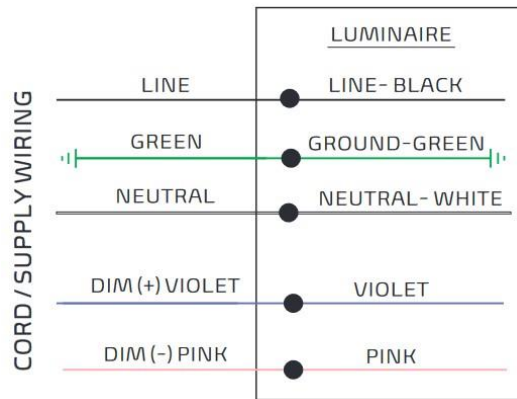

- Please isolate the two dimming wires by P2 terminal individually if not using dimming
- MUST connect wires with corresponding colors as shown.

**WARNING**

- Before installing, servicing, or performing routine maintenance upon this equipment, follow these general precautions.
- To reduce the risk of death, personal injury, or property damage from fire, electric shock, falling parts, cuts/abrasions, and other hazards, read all warnings and instructions included with and on the fixture box and all fixture labels.
- Proper grounding is required to ensure safety.
- Power must be turned off at the breaker before installation or maintenance.
- This product must be installed in accordance with the applicable installation code by a person familiar with the construction and operation of the product and the hazards involved.
- Wear gloves and eye protection at all times while installing, servicing, or performing maintenance on the luminaire, and avoid direct eye exposure to the light source while it is on.
- To prevent wiring damage or abrasion, do not expose wiring to edges of sheet metal or other sharp objects.

- Do not install damaged product. Inspect luminaire for damage that may have occurred during transit. If damaged, contact the manufacturer immediately.
- These instructions do not purport to cover all details or variations in equipment nor to provide every possible contingency to meet in connection with installation, operation, or maintenance. Should further information be desired or should particular problems arise which are not covered sufficiently for the purchaser's or owner's purposes, contact the manufacturer.

## **⚠ ADVERTENCIA**

- Antes de instalar, reparar o realizar el mantenimiento de rutina de este equipo, siga estas precauciones generales.
- Para reducir el riesgo de muerte, lesiones personales o daños a la propiedad por fuego, descarga eléctrica, caída de piezas, cortes / abrasiones y otros peligros, lea todas las advertencias y instrucciones incluidas con y en la caja del dispositivo y todas las etiquetas del dispositivo.
- Se requiere una conexión a tierra adecuada para garantizar la seguridad.
- Se debe apagar la energía en el disyuntor antes de la instalación o el mantenimiento.
- Este producto debe ser instalado de acuerdo con el código de instalación aplicable por una persona familiarizada con la construcción y operación del producto y los peligros involucrados.
- Utilice guantes y protección para los ojos en todo momento durante la instalación, el servicio o el mantenimiento de la luminaria, y evite la exposición directa de los ojos a la fuente de luz mientras está encendida.
- Para evitar daños o abrasiones en el cableado, no exponga el cableado a bordes de láminas de metal u otros objetos afilados.
- No instale un producto dañado. Inspeccione la luminaria en busca de daños que puedan haber ocurrido durante el tránsito. Si está dañado, comuníquese con el fabricante de inmediato.
- Estas instrucciones no pretenden cubrir todos los detalles o variaciones en el equipo ni proporcionar todas las posibles contingencias a cumplir en relación con la instalación, operación o mantenimiento. Si desea obtener más información o si surgen problemas particulares que no están suficientemente cubiertos para los propósitos del comprador o propietario, comuníquese con el fabricante.