

DESCRIPTION

Reduce energy and maintenance costs by replacing existing 1x4, 2x2, or 2x4 fluorescent fixtures with these more efficient color and wattage selectable LED surface mount panels. These panels are edge-lit allowing for an overall slimmer design that eases the installation process and modernizes the space.

FEATURES

- Efficiently replaces up to a 3 lamp fluorescent fixture
- Dimmable with 0-10V dimmers; see Compatible Dimmers section for full list of compatible dimmers
- Light output varies depending on wattage and color temperature selected; see Selectable Table for full breakdown
- Wattage and color temperature is selectable via switches on the back of the fixture; see installation instruction for more information

LISTINGS

- UL rated for damp locations

PERFORMANCE

- CRI: 80
- CCT: 3000K, 4000K, and 5000K
- LED L70 Life Hours @25°C: >54,000 hours

THERMAL

- -4°F to 104°F (-20°C to 40°C) operating temperature

ELECTRICAL

- THD: <20%
- Power Factor: >0.9
- Input Voltage: 120-277V
- Output Voltage: 30-42V
- Dimmable power supply (1-10V)
- Surge Protection: 1kV

INSTALLATION

- Designed for surface mounting with included hardware; see installation instructions for more information

CONSTRUCTION

- Extruded aluminum housing with white finish
- Frosted PMMA lens protects LEDs while evenly distributing light

Project name	Type
Catalog number	
Comments	Voltage
Approved by	Date

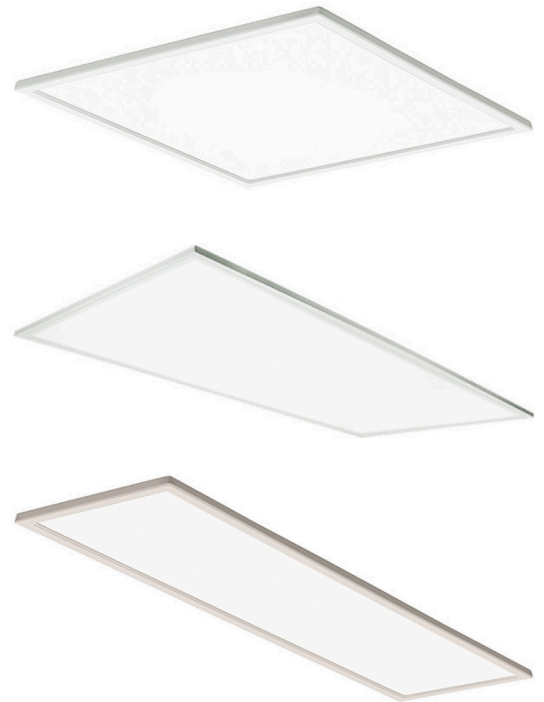

WARRANTY

- 5 year limited warranty; see pltsolutions.com for warranty details

APPLICATIONS

- Conference Rooms
- Retail
- Offices
- Hospitality
- Healthcare
- Schools
- Reception Areas

PERFORMANCE SUMMARY

Item #	Size	Watts*	CCT*	CRI	Dimming	Voltage	Replaces	Default Setting
PLT-90341	2x2	20/ 30/ 40	3000K/ 4000K/ 5000K	80	1-10V	120-277V	2 Lamp Fluorescent	40W, 4000K
PLT-90342	2x4	30/ 40/ 50	3000K/ 4000K/ 5000K	80	1-10V	120-277V	3 Lamp Fluorescent	50W, 4000K
PLT-90343	1x4	20/ 30/ 40	3000K/ 4000K/ 5000K	80	1-10V	120-277V	2 Lamp Fluorescent	40W, 4000K

* See Selectable Table for full breakdown

SELECTABLE TABLE

Item #	Wattage	CCT	Lumens	Efficacy
PLT-90341	20	3000K	2425	119
		4000K	2507	126
		5000K	2522	123
	30	3000K	3454	115
		4000K	3616	124
		5000K	3575	119
	40	3000K	4445	111
		4000K	4671	121
		5000K	4573	114
PLT-90342	30	3000K	3545	118
		4000K	3801	131
		5000K	3842	127
	40	3000K	4455	114
		4000K	4828	128
		5000K	4834	123
	50	3000K	5402	109
		4000K	5901	125
		5000K	5822	117
PLT-90343	20	3000K	2000	100
		4000K	2300	115
		5000K	2200	110
	30	3000K	3300	100
		4000K	3450	115
		5000K	3300	110
	40	3000K	4000	100
		4000K	4600	115
		5000K	4400	110

COMPATIBLE DIMMERS

Brand	Model #
Lutron	DVLV
Leviton	IP-710-DL

FIXTURE DIMENSIONS

PLT-90341 DIMENSIONS

Length: 23.7"

Height: 0.7"

Width: 23.7"

Weight: 7.72 lbs

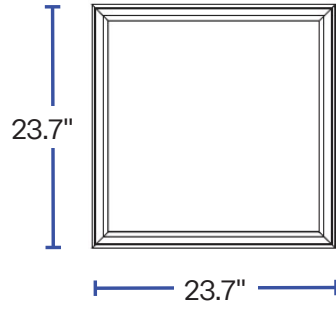

PLT-90342 DIMENSIONS

Length: 47.7"

Height: 0.7"

Width: 23.7"

Weight: 14 lbs

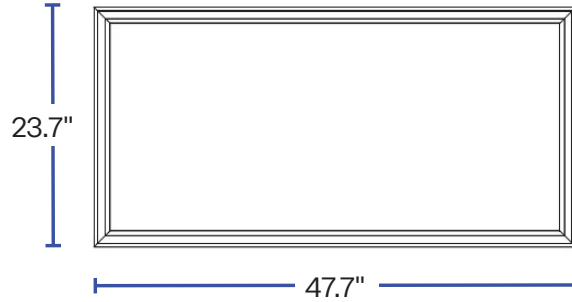

PLT-90343 DIMENSIONS

Length: 47.7"

Height: 0.7"

Width: 11.7"

Weight: 7.39 lbs

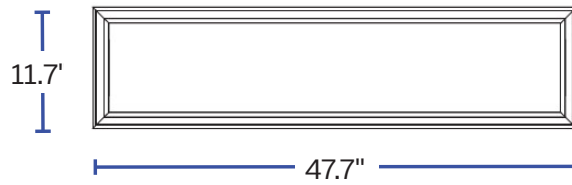

PHOTOMETRICS

PLT-90341 @ 4000K

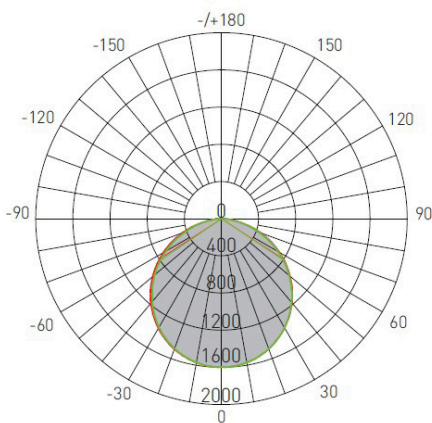

AVERAGE BEAM ANGLE(50%): 112.7°

PLT-90342 @ 4000K

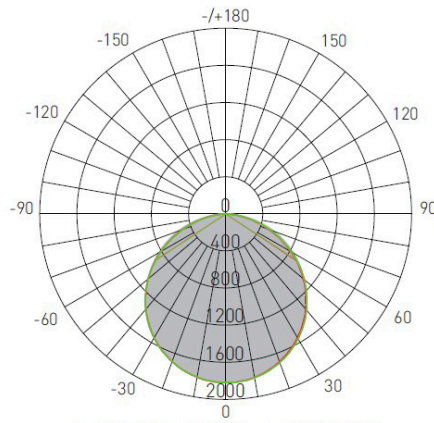

AVERAGE BEAM ANGLE(50%): 113.1°

PLT-90343 @ 4000K

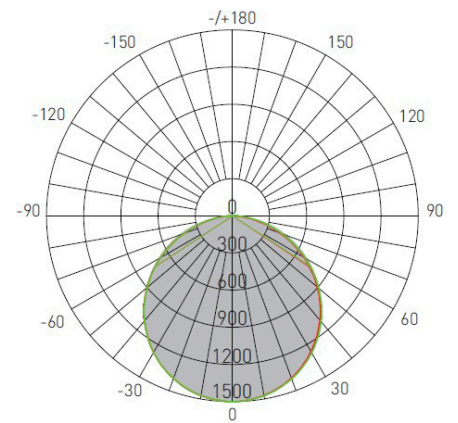

AVERAGE BEAM ANGLE(50%): 113.3°