



Libertyville, Illinois 60048

www.intermatic.com

Ascend™

Timer Installation & Operation Manual



*STW700W Smart In-Wall Timer/
ST700W Standard In-Wall Timer*

COMPLIANCE

This device complies with part 15 of the FCC. Operation is subject to the following two conditions: (1) this device may not cause harmful interference, and (2) this device must accept any interference received, including interference that may cause undesired operation.

FCC NOTE: The manufacturer is not responsible for any radio or TV interference caused by unauthorized modifications to this equipment. Such modifications could void the user's authority to operate the equipment.

NOTE: This equipment has been tested and found to comply with the limits for a Class B digital device, pursuant to Part 15 of the FCC Rules. These limits are designed to provide reasonable protection against harmful interference in a residential installation. This equipment generates, uses and can radiate radio frequency energy and, if not installed and used in accordance with the instructions may cause harmful interference to radio communications. However, there is no guarantee that interference will not occur in a particular installation. If this equipment does cause harmful interference to radio or television reception, which can be determined by turning the equipment off and on, the user is encouraged to try to correct the interference by one or more of the following measures:

- Reorient or relocate the receiving antenna.
- Increase the separation between the equipment and receiver.
- Connect the equipment into an outlet on a circuit different from that to which the receiver is connected.
- Consult the dealer or an experienced radio/TV technician for help.

Important note: To comply with the FCC RF exposure compliance requirements, no change to the antenna or the device is permitted. Any change to the antenna or the device could result in the device exceeding the RF exposure requirements and void user's authority to operate the device.

This Class B digital apparatus complies with ICES-005 of Canada.

WARNINGS/SAFETY

WARNING

Risk of Fire or Electric Shock

- Disconnect power at the circuit breaker(s) or disconnect switch(es) before installing or servicing.
- Installation and/or wiring must be in accordance with national and local electrical code requirements.
- Only use copper conductors rated 105°C minimum
- Battery is not user replaceable.
- Do NOT use timer to control devices that could have dangerous consequences due to inaccurate timing, such as sun lamps, saunas, heaters, and crock pots.

NOTICE

Dispose of product per local regulations on the disposal of lithium batteries.

Ratings¹

Operating Voltage	120 VAC, 50/60 Hz
General Purpose	15 A
Inductive Ballast	15 A
Tungsten/Incandescent	8 A
Electronic Ballast/LED	5 A
LED Load	600 W
Motor Load	1 HP
Dimensions	2 3/4" H x 1 3/4" W x 1 2/3" D

¹Type 1.C Action Operating Control, Pollution Degree 2, Impulse Voltage 2500 V

SINGLE-POLE WIRING

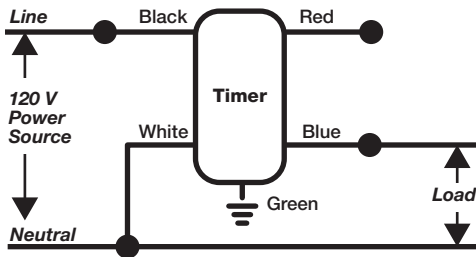

Wire	Description
Blue	Connects to black wire from Load
White	Connects to white (neutral) wire from Load and Power Source
Black	Connects to black (hot) wire from Power Source
Green	Connects to ground
Red	Not used in single-pole installations

Note: *To be installed in single- and double-gang with 2-1/2" minimum depth. Please consult a qualified electrician for specific wiring details.*

TYPICAL THREE-WAY WIRING

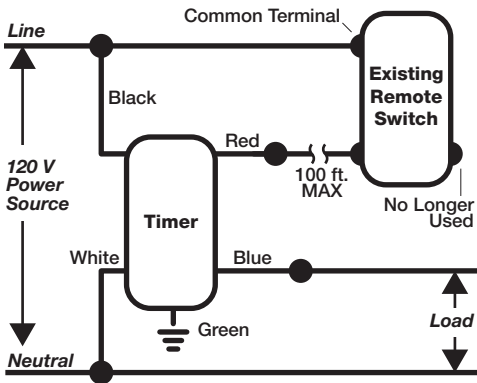

Wire	Description
Blue	Connects to black wire from Load
White	Connects to white (neutral) wire from Load and Power Source
Black	Connects to black (hot) wire from Power Source
Green	Connects to ground
Red	Connects through remote switch to black (hot) wire from Power Source

Note: For other three-way wiring scenarios, go to www.Intermatic.com/Ascend.

PRODUCT OVERVIEW

The Ascend 7-Day Timer portfolio consists of two timer models: ST700W Standard and STW700W Wi-Fi enabled. In addition to the intuitive control interface common to both models, the Wi-Fi enabled Timer offers a mobile app for access to a quick setup feature, the ability to save schedules for easy transfer to other Ascend Wi-Fi enabled timers, and convenient monitoring from compatible Apple or Android mobile devices.

Access Point Mode

- Creates a peer to peer communication network between the Timer and your mobile device to offer a direct connection for initial setup, scheduling, and control of your Timer.

Wi-Fi Mode (Local)

- Connects the Timer to your local wireless network.
- Provides the benefit of constant connection with every Timer on your network, when using the app.

Remote Access (Cloud)

- Establishing an Intermatic Connect Account and registering a Timer(s) with your account, enables access from anywhere you have an active Wi-Fi or cellular connection.

Voice Integration

- Works with Alexa and Google Home. Setup required using the Alexa or Google Home apps. See our website for installation details.
- When paired with Alexa or Google Home, users can command the Timer ON/OFF, Change Mode or get Timer status.

Setup Instructions

ST700W:

- Go to the Initial Setup at Timer section for instructions.

STW700W:

- Go to the Initial Setup at Timer section for instructions.
- Go to the Apple Store or Google Play Store and download the Intermatic Connect App. Follow the instructions in the App to set up your timer.

SWITCH INTERFACE

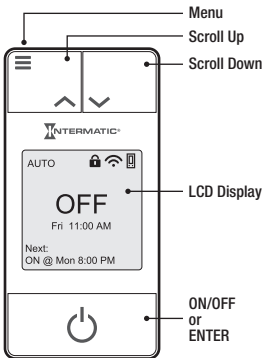

Icon	Description
	Timer locked
	Wi-Fi active
	Access Point Mode <i>Timer Connected</i>
	Access Point Mode <i>Timer waiting for connection</i>
	Wi-Fi Mode <i>Timer connected to network</i>
	Wi-Fi Mode <i>Timer not connected to network</i>

LCD Display

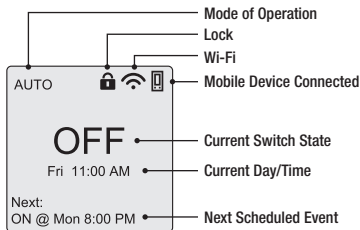

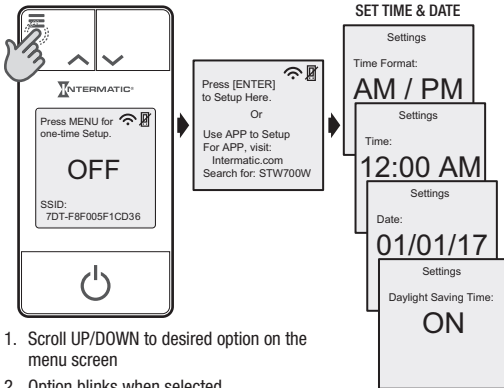

Note: *Display icons change based on timer model and programmed settings.*

INITIAL SETUP AT TIMER



1. Scroll UP/DOWN to desired option on the menu screen
2. Option blinks when selected
3. Press ENTER to confirm and move to the next menu

Note:

- *The app setup option is only applicable to the STW700W Wi-Fi enabled model. Press ENTER to begin setup for the ST700W standard model.*
- *You must complete all screens before returning to the Timer interface screen.*
- *Refer to **page 11** for descriptions of **Schedule Templates**.*
- *Refer to the **Latitude/Longitude** estimation chart on **page 20** or perform an app or Internet search for location specific values.*
- *The SSID and the  and  icons are not available for the ST700W.*

ENTER LOCATION SETTINGS

Settings

Latitude:
42.0°

Settings

Longitude:
-82.5°

SELECT COUNTRY

Settings

Country:
USA
Mexico
Canada

SET TIME ZONE

Settings

Timezone:
Pacific
Mountain
Central
Eastern

PRESS
ENTER

**Settings
Saved**

SELECT SCHEDULE

Schedule

- 1 ON all night
- 2 ON evenings
- 3 ON morning/evening
- 4 Custom Schedule
- 5 Cancel

SETUP SCHEDULE?



Do you want to
setup a schedule?

YES

Yes

No

SETUP COMPLETE



AUTO  

OFF

Fri 11:00 AM

Next:
ON @ Mon 8:00 PM

SETUP COMPLETE

MANUAL  

OFF

Fri 11:00 AM

MODES

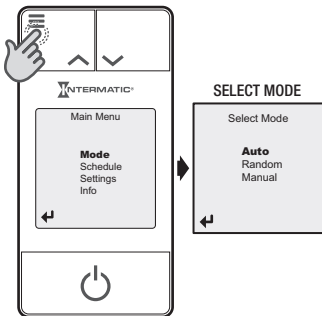

Auto	Timer operates using your programmed schedule of weekly ON/OFF events.
Random	Similar to Auto mode except that your programmed schedule occurs randomly at +/- 15 minutes from the programmed time.
Manual	Operates like a manual toggle switch to turn devices ON and OFF, regardless of any schedules programmed in the timer.

Note: *To enter Auto or Random mode, a programmed schedule must be loaded into memory.*

SCHEDULE TEMPLATES

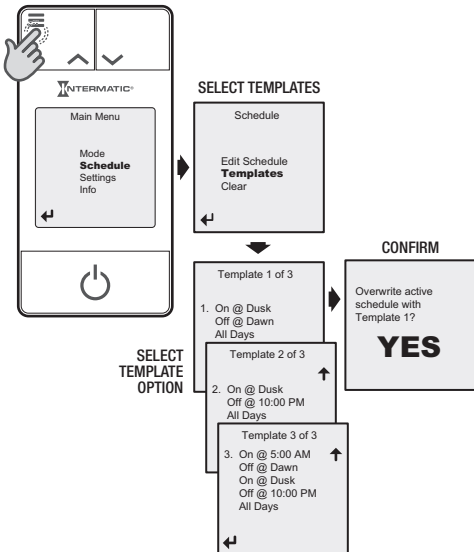

Note:

- A Template is a pre-set schedule of events that overrides your current schedule when chosen.
- Once a Template becomes your current schedule, you can edit the events.
- Template events in this menu cannot be altered.
- Reference **page 14** to **Edit Schedule** events.

NEW SCHEDULE

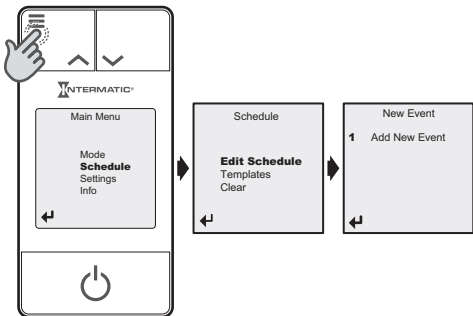

Menu Options

Action

1. Enter to modify Action
 - **Turn OFF** blinks
2. Scroll UP/DOWN to select:
 - Turn On
 - Turn Off
3. ENTER to confirm

Event 1 (new):	
Action:	Turn Off
Days:	No Days
Time:	No Time
←	Cancel

Note: At any time, scroll to ← and press ENTER to go back to the Main Menu or choose Cancel to cancel input.

Days

1. Enter to modify Days
 - **No Days** blinks
2. Scroll UP/DOWN to select:
 - All Days
 - Weekdays
 - Weekends
 - Define Days
 - a. UP/DOWN to select/deselect days
 - b. ENTER to confirm day
 - c. Select  to confirm
3. ENTER to confirm

Event 1 (new):

Action: Turn On
Days: **No Days**
Time: No Time

 Cancel

Event 1 (new):

Days of Week:

<input checked="" type="checkbox"/> Sun	<input type="checkbox"/> Thu
<input type="checkbox"/> Mon	<input checked="" type="checkbox"/> Fri
<input checked="" type="checkbox"/> Tue	<input type="checkbox"/> Sat
<input checked="" type="checkbox"/> Wed	



Time

1. Enter to modify Time
 - **No Time** blinks
2. Scroll UP/DOWN to select:
 - Define Time
 - Dusk
 - Dawn
3. ENTER to confirm selection
4. UP/DOWN to increase/decrease time
5. ENTER to confirm

Event 1 (new):

Action: Turn On
Days: No Days
Time: Dawn
0 mins Offset

 Cancel

Event 1 (new):

Action: Turn On
Days: No Days
Time: Define Time
12:00 AM

 Cancel

Note: *The Offset function allows Dusk/Dawn events to activate before or after the actual Dusk/Dawn time for your location. You can set an offset of +/- 0 to 120 minutes.*

EDIT SCHEDULE

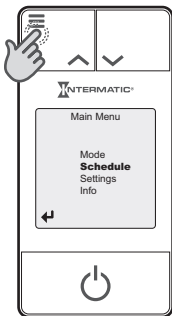

SELECT EDIT SCHEDULE

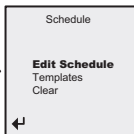

SCROLL UP/DOWN TO SELECT EVENT

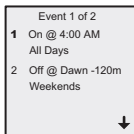

Note: *Clear will delete the current schedule.*





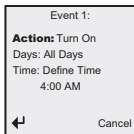
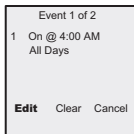
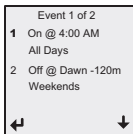

Edit Event



- ENTER to select event
 - EDIT to change the event (Refer to **page 12** for options)
 - CLEAR to remove event from schedule

ERROR MESSAGES

Error	Resolution
 No Days	Add a day to your event. Options include: <ul style="list-style-type: none">• All Days• Weekdays• Weekends• Define Days
 Duplicates	A duplicate event exists. Modify or cancel your event.
 No Time	Add a time to your event. Options include: <ul style="list-style-type: none">• Define Time• Dusk• Dawn
 No Memory	Remove an event before adding a new one.

SETTINGS

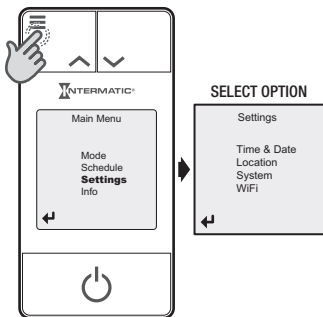

Menu Options

Time & Date

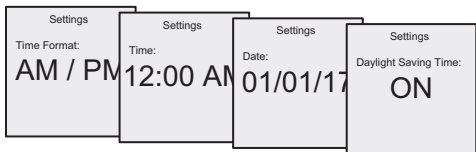

Select a 12-hour am/pm or 24-hour time format. Choose the time and date then choose to turn Daylight Saving Time ON or OFF.

Location

Settings Latitude: 42.0°	Settings Longitude: -82.5°	Settings Country: USA Mexico Canada	Settings Timezone: Pacific Mountain Central Eastern
---------------------------------------	---	---	--

Program your latitude, longitude, country and timezone.

System

Settings Lock Timer: OFF To Unlock, hold [Up]/[Dn] buttons.	Settings Auto-Sleep: ON Display is dimmed after inactivity.	Settings System Restart: YES Keeps all settings and schedule.	Settings Set Factory Defaults: YES Erases all settings and schedule.
--	--	--	---

Lock Timer	<ul style="list-style-type: none">Prevents access to Timer schedules and functionsTo unlock: press and hold the UP and DOWN buttons for three seconds
Auto-Sleep	Dims display after one minute of inactivity
System Restart	<ul style="list-style-type: none">Resets timer but maintains all settings and schedulesRestores communication between the timer and routerApplies to STW700W only
Set Factory Defaults	<ul style="list-style-type: none">Restores timer to out-of-box conditionClears programming, time settings, schedules, error log and wi-fi settings

Wi-Fi

Clears and resets your Wi-Fi to Access Point Mode. To re-establish a Wi-Fi connection refer to the app.

Settings Reset WiFi: NO Erases WiFi settings.
--

INFO MENU OVERVIEW

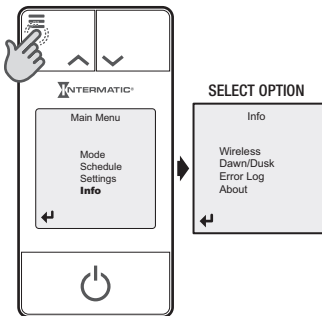

Menu Options

Wireless Settings (STW700W model only)

This option lets you view your IP Address, identify your Timer SSID number, and view your security PIN information.

Note: *Your security PIN is a unique code that allows the app to connect to your Timer.*



Dawn/Dusk

This option shows you the current time, the date, and the time associated with Dawn or Dusk in your set location.

Dawn/Dusk

Time: 4:53 AM
Date: 08/04/16
Loc: 27.1 , -169.2
Dawn: 7:15 AM
Dusk: 10:02 PM

Error Log

Scroll UP/DOWN through the error log to view any issues logged in your system.

Error Log

Error 1 of 10:

Date: 06/23/2016
Time: 11:42 PM
Error: E-7

About

View the information associated with your timer, including model, version, and manufacturing date. You can also find contact details for Intermatic, Inc.

About

Model: STW700W
v01.00.04
Mfg: 01L
Intermatic, Inc.
1.815.675.7000
Intermatic.com

LATITUDE/LONGITUDE

Major United States Cities

City	Lat. n°	Long. w°
Albany, NY	43	-74
Albuquerque, NM	35	-107
Amarillo, TX	35	-102
Anchorage, AK	61	-150
Atlanta, GA	34	-84
Austin, TX	30	-98
Baker, OR	45	-118
Baltimore, MD	39	-77
Bangor, ME	45	-69
Birmingham, AL	34	-87
Bismarck, ND	47	-101
Boise, ID	44	-116
Boston, MA	42	-71
Buffalo, NY	43	-79
Carlsbad, NM	32	-104
Charleston, WV	38	-82
Charlotte, NC	35	-81
Cheyenne, WY	41	-105
Chicago, IL	42	-88
Cincinnati, OH	39	-85
Cleveland, OH	41	-82
Columbia, SC	34	-81
Columbus, OH	40	-83
Dallas, TX	33	-97
Denver, CO	40	-105
Des Moines, IA	42	-94
Detroit, MI	42	-83
Dubuque, IA	43	-91
Duluth, MN	47	-92
El Paso, TX	32	-106
Eugene, OR	44	-123
Fargo, ND	47	-97
Flagstaff, AZ	35	-112

City	Lat. n°	Long. w°
Fresno, CA	37	-120
Grand Rapids, MI	43	-86
Helena, MT	47	-112
Honolulu, HI	21	-158
Hot Springs, AR	35	-93
Houston, TX	30	-95
ID Falls, ID	44	-112
Indianapolis, IN	40	-86
Jackson, MS	32	-90
Jacksonville, FL	30	-82
Juneau, AK	58	-134
Kansas City, MO	39	-95
Key West, FL	25	-82
Klamath Falls, OR	42	-122
Knoxville, TN	36	-84
Las Vegas, NV	36	-115
Los Angeles, CA	34	-118
Louisville, KY	38	-86
Manchester, NH	43	-72
Memphis, TN	35	-90
Miami, FL	26	-80
Milwaukee, WI	43	-88
Minneapolis, MN	45	-93
Mobile, AL	31	-88
Montgomery, AL	32	-86
Montpelier, VT	44	-73
Nashville, TN	36	-87
New Haven, CT	41	-73
New Orleans, LA	30	-90
New York, NY	41	-74
Nome, AK	64	-166
Oklahoma City, OK	35	-97
Philadelphia, PA	40	-75

Major Canadian Cities

City	Lat. n°	Long. w°
Calgary, AL	51	-114
Edmonton, AL	54	-113
Fredericton, NB	46	-67
Halifax, NS	45	-64
London, ON	43	-82
Montreal, QC	46	-74
Nelson, BC	50	-117
Ottawa, ON	45	-76
Quebec, QC	53	-74
Regina, SK	50	-105
Toronto, ON	44	-79
Vancouver, BC	49	-123
Whitehorse, YT	61	-135
Winnipeg, MB	50	-97

Major Mexican Cities







City	Lat. n°	Long. w°
Acapulco	17	-100
Cancún	21	-87
Colima	19	-104
Culiacán	25	-107
Durango	24	-105
Guadalajara	21	-103
La Paz	24	-110
León	21	-102
Mérida	21	-90
Mexico City	19	-99
Monterrey	26	-100
Morelia	20	-101
Oaxaca	17	-97
Querétaro	21	-100
Tepic	22	-105
Tuxtla Gutiérrez	17	-93
Veracruz	19	-96
Villahermosa	18	-93
Zacatecas	23	-103

City	Lat. n°	Long. w°
Phoenix, AZ	33	-112
Pierre, SD	44	-100
Pittsburgh, PA	40	-80
Portland, ME	44	-70
Portland, OR	46	-123
Providence, RI	42	-71
Raleigh, NC	36	-79
Reno, NV	40	-120
Richfield, UT	39	-112
Richmond, VA	38	-77
Roanoke, VA	37	-80
Sacramento, CA	39	-122
Salt Lake City, UT	41	-112
San Antonio, TX	29	-99
San Diego, CA	33	-117
San Francisco, CA	38	-122
San Juan, PR	19	-66
Savannah, GA	32	-81
Seattle, WA	48	-122
Shreveport, LA	32	-94
Sioux Falls, SD	44	-97
Spokane, WA	48	-117
Springfield, IL	40	-90
Springfield, MO	37	-93
St. Louis, MO	39	-90
Syracuse, NY	43	-76
Tampa, FL	28	-82
Virginia Beach, VA	37	-76
Washington, D.C.	39	-77
Wichita, KS	38	-97
Wilmington, NC	34	-78

Note: *These charts provide approximate information on your Latitude and Longitude. Perform an app or Internet search for location specific values.*

TROUBLESHOOTING

Problem	Possible Cause	What To Do
Timer won't enter Auto or Random mode when you press Mode.	A schedule is not saved.	Choose a template or define a schedule of events.
Timer switches at incorrect times or skips some of the programmed times.	The active schedule has an invalid setting.	Review the settings and revise them as necessary.
	Timer is in Random mode, which varies switching times up to +/- 15 minutes.	Select the Auto Mode.
	The Astronomic and Defined switching times are in conflict, your DST may or may not be turned on, or your timezone and location are not configured properly. Note: <i>Your switch timer automatically skips any conflicting ON event as summer approaches to prevent unwanted operation of lights or other controlled devices.</i>	Review your program settings and revise them as necessary.
Load only operates when the remote (3-way) switch is in one position or the Timer ignores the remote switch.	The remote switch is wired incorrectly.	Recheck the wiring, especially for the jumper.
The Timer ignores a 3-way remote switch even though it is wired correctly or the load turns off immediately after being turned ON.	<ul style="list-style-type: none"> • The remote switch or switch timer is wired wrong. • There is an excessive length of wire (greater than 100 feet). • There is buried wire to the remote switch. • The remote switch is not functioning properly or worn out. 	Contact a qualified electrician.
Timer shows ON but the light or other controlled device is OFF.	The light or controlled device itself may be switched OFF.	Make sure the light or controlled device is switched ON and plugged in.
Screen is OFF.	Timer is set up in Sleep Mode to turn the screen OFF after one minute of inactivity.	<ul style="list-style-type: none"> • Hit any key to wake up Timer. • To keep screen ON all the time, change the Sleep Mode setting to OFF.

Problem	Possible Cause	What To Do
Timer is not connecting to my local Wi-Fi network. (applies to STW700W only)	Timer display shows:  or  icon. Timer is in Access Point Mode or the Access Point Mode is not connected.	Follow app instructions to connect the Timer to your local Wi-Fi network
	Timer shows:  icon. Timer is waiting for a connection. The router password for the local router may be incorrect.	<ul style="list-style-type: none"> • Check Wi-Fi router to make sure it is ON. • Use app to revise Wi-Fi settings and reconnect to your router.
Can't connect my mobile device to my Timer. (applies to STW700W only)	No  icon is showing. Model does not have a Wi-Fi radio, or the radio is not turning ON.	<ul style="list-style-type: none"> • Make sure you have the STW700W Wi-Fi enabled Timer model. • Try resetting the W-Fi and Timer. If problem persists, contact Intermatic.
	 icon is showing. Timer is connected to a Wi-Fi network. The mobile device may not be connected to the same network.	<ul style="list-style-type: none"> • Make sure your mobile device is connected to the same local Wi-Fi network. • To disconnect Timer from current Wi-Fi network, perform a Wi-Fi reset at the Timer.
	 icon is showing. Timer is in Access Point Mode, waiting for mobile device connection.	Follow app instructions to connect to Timer. Make sure you are not in a wireless "dead zone" when attempting to connect.
	 icon is showing. Timer is already connected to a mobile device.	<ul style="list-style-type: none"> • Check your mobile device Wi-Fi settings. If connected to the 7DT-xxx network, go to the app and choose Search. • If your mobile device is not connected, there is another mobile device already connected. Disconnect the other device.

Note: For more troubleshooting tips, contact Intermatic Tech Support at: 815-675-7000.

WARRANTY

WARRANTY LIMITED WARRANTY

Warranty service is available by either (a) returning the product to the dealer from whom the unit was purchased or (b) completing a warranty claim online at www.intermatic.com. This warranty is made by: Intermatic Incorporated, Customer Service 1950 Innovation Way, Suite 300, Libertyville, IL 60048.

For warranty service go to: <http://www.Intermatic.com> or call 815-675-7000. For complete information on Intermatic products, literature and Contractors Guides visit www.intermatic.com.