



DESCRIPTION

Add these easy to install wattage and color selectable LED downlights as part of new construction or renovation projects.

FEATURES

- Energy efficient replacement for 50W incandescents
- Light output will vary depending on the color temperature selected, see Selectable Table for more information
- IC Rated and air-tight
- Does not require a recessed housing
- High color rendering index (CRI) of 90 makes color appear more accurate
- Dimmable; see Compatible Dimmers section for full list of compatible dimmers
- Color temperature can be adjusted via switch on the top of the fixture; see installation instructions for more information

LISTINGS

- ETL Listed for wet locations
- JA8
- RoHS
- IC Rated

PERFORMANCE

- CRI: 90
- CCT: 2700K, 3000K, 3500K, 4000K, and 5000K
- Rated Lifetime L70: 50,000 hours

ELECTRICAL

- THD: 19.3%
- Power Factor: >0.9
- Input Voltage: 120V
- Surge protection: 2.5kV

THERMAL

- -4°F to 104°F (-20°C to 40°C) operating temperature

CONSTRUCTION

- Aluminum body and round trim, both with white finish
- Acrylic lens

project name	type
catalog number	
comments	voltage
approved by	date



RoHS
Compliant



JA8

WARRANTY

- 3-year limited warranty; see pltsolutions.com for warranty details

APPLICATIONS

- Offices
- Lobbies
- Conference Rooms
- Living Rooms
- Hallways
- Bathrooms
- Laundry Rooms

PERFORMANCE	Power Consumption*	7, 8 Watt
	CRI	90
	CCT*	2700K, 3000K, 3500K, 4000K, 5000K
	Beam Angle	38°
ELECTRICAL	LED L70 Life Hours	50,000
	Power Factor	>0.9
	THD	19.3%
CONSTRUCTION	Input Voltage	120V
	Housing	Aluminum
	Lens	Clear
LISTINGS	Certifications	ETL Listed, IC, RoHS, JA8
	Environment	Wet Location Rated

* See Selectable Table for full breakdown

PERFORMANCE SUMMARY

Item #	Size	Wattage	CCT*	Voltage	Replaces	CRI	LED L70 Life Hours	Dimmable	Trim	Default Setting
PLT-12604	2"	7	2700K/ 3000K/ 3500K/ 4000K/ 5000K	120V	50W	90	50,000	Yes	Smooth	20W, 3000K
PLT-12605	3"	8	2700K/ 3000K/ 3500K/ 4000K/ 5000K	120V	50W	90	50,000	Yes	Baffled	40W, 3000K

* See Selectable Table for full breakdown

SELECTABLE TABLE

Wattage	CCT	Lumen	Efficacy
7	2700K	464	66
	3000K	499	71
	3500K	526	75
	4000K	536	77
	5000K	518	74
8	2700K	533	67
	3000K	560	70
	3500K	610	76
	4000K	636	79
	5000K	642	80

COMPATIBLE DIMMERS

Brand	Model	Load	Dimmability
LUTRON	AYCL-153P	150W	10%-100%
	DV-600PR	600W	1%-100%
	DVCL-153P	150W	10%-100%
	MACL-153MH	600W	10%-100%
	MRF2-6CL	600W	10%-100%
	D-600P	600W	10%-100%
	NTELV-300P	600W	10%-100%
	S-600P	600W	10%-100%
	CT-600P	600W	1%-100%
	CTCL-153P	600W	10%-100%
	TG-600P	600W	10%-100%
TCCL-153P	600W	1%-100%	
LEVITON	6633	600W	20%-100%
	6674	700W	20%-100%
	6602	700W	10%-100%
	IPL06	1000W	1%-100%
LEGRAND	ADTP703TU	300W	20%-100%
	H703PTW	150W	10%-100%
COOPER	9540	600W	10%-100%
	DAL06P	150W	10%-100%

DOWNLIGHT DIMENSIONS

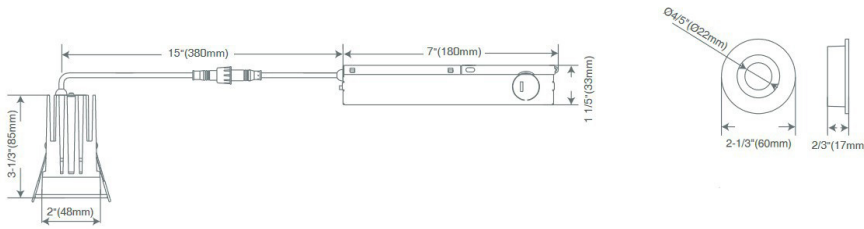

DIMENSIONS PLT-12604

Height – 3.35"

Diameter w/o Trim – 2"

Round Trim Inside Diameter – 1.38"

Round Trim Outside Diameter – 2.36"

Cable Length – 13"

Driver Box Length – 7"

Driver Box Height – 1.20"

Driver Box Width – 1.20"

Weight – 0.79 lbs

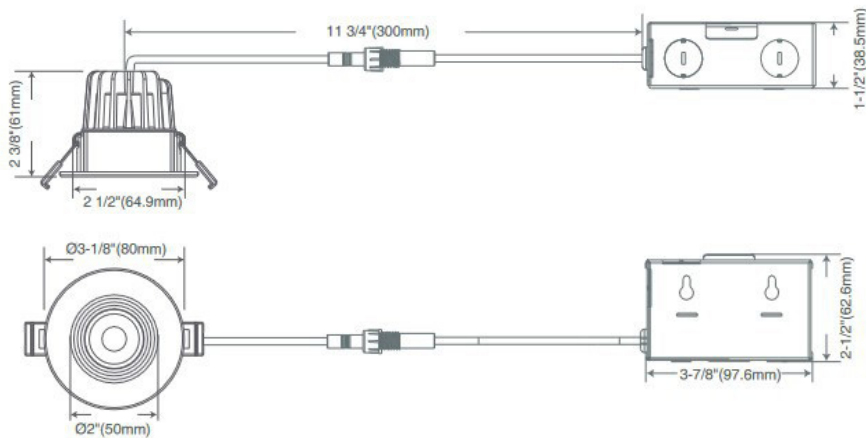

DIMENSIONS PLT-12605

Height – 2.40"

Diameter w/o Trim – 2.5"

Round Trim Inside Diameter – 2"

Round Trim Outside Diameter – 3.15"

Cable Length – 11.75"

Driver Box Length – 3.84"

Driver Box Height – 1.5"

Driver Box Width – 2.5"

Weight – 0.93 lbs

WARNINGS

- Only use this LED downlight with the dimmers listed in the compatibility list. Using this downlight with incompatible dimmers may cause performance issues including humming, buzzing, flickering, and poor dimming performance.
- Hole cut size: PLT-12604 – 2.13"; PLT-12605 – 2.63"

PLT-12604 2700K

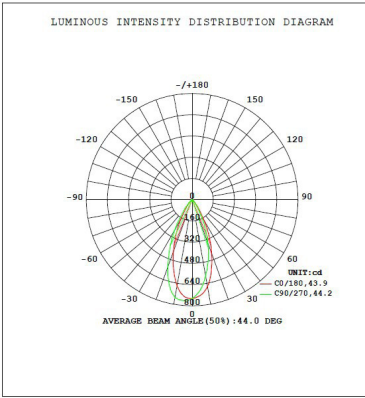

PLT-12604 3000K

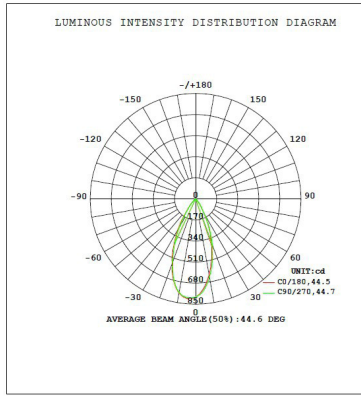

PLT-12604 3500K

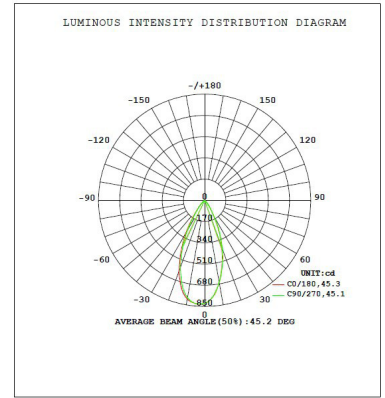

PLT-12604 4000K

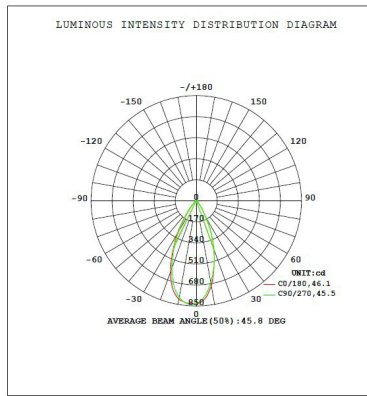

PLT-12604 5000K

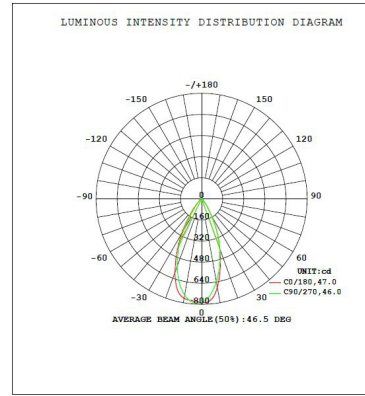

PLT-12605 2700K

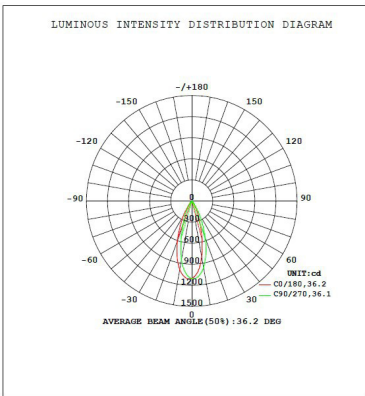

PLT-12605 3000K

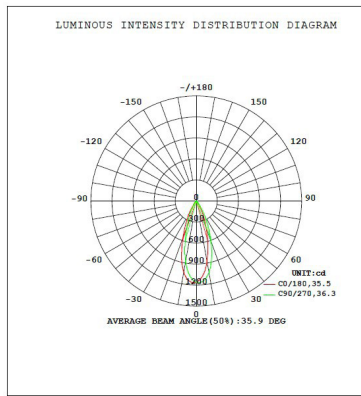

PLT-12605 3500K

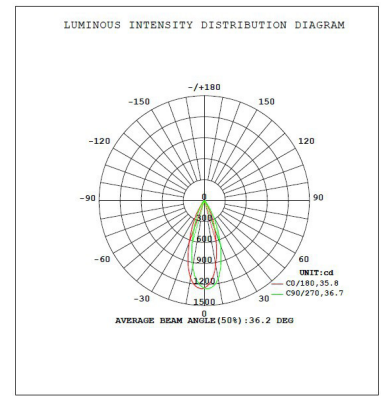

PLT-12605 4000K

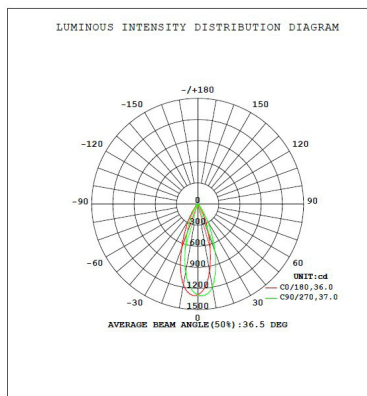

PLT-12605 5000K

