

DESCRIPTION

Greatly reduce energy and maintenance costs by replacing existing fluorescent strip fixtures with these more efficient color selectable LED strip light fixtures that feature both direct and indirect lighting.

FEATURES

- Provides 70% direct lighting, 30% indirect lighting; see Selectable Table for full breakdown
- 0-10V dimming
- Multiple fixtures can be linked end-to-end using joiner (PLT-90317, sold separately); see End-to-End Linking section for more information
- 3.9' power cord
- Direct and indirect lighting color temperature is adjusted via dip switch on the top of the fixture; see installation instructions for more details

LISTINGS

- UL rated for damp locations
- FCC
- RoHS
- DesignLights Consortium® 5.1 Standard - meets the requirements for the highest DLC qualification for efficacy and lumen maintenance

PERFORMANCE

- CRI: 80
- CCT: 3500K, 4000K, and 5000K
- LED L70 Life Hours: >100,000

LISTINGS

- -4°F to 122°F (-20°C to 50°C) operating temperature

ELECTRICAL

- THD: <20%
- Power Factor: >0.9
- Input Voltage: 120-277V
- Dimmable power supply (0-10V)

INSTALLATION

- Designed for suspension mounting (3.3' cables (2), canopies (2), and suction cup included); see installation instructions for more details
- Recommended mounting height of 18 to 24" below the ceiling to help disperse the light output better.

CONSTRUCTION

- Cold-rolled steel housing with white, silver, or black finish
- Frosted PC lens protects LEDs while evenly distributing light

project name	type
catalog number	
comments	voltage
approved by	date

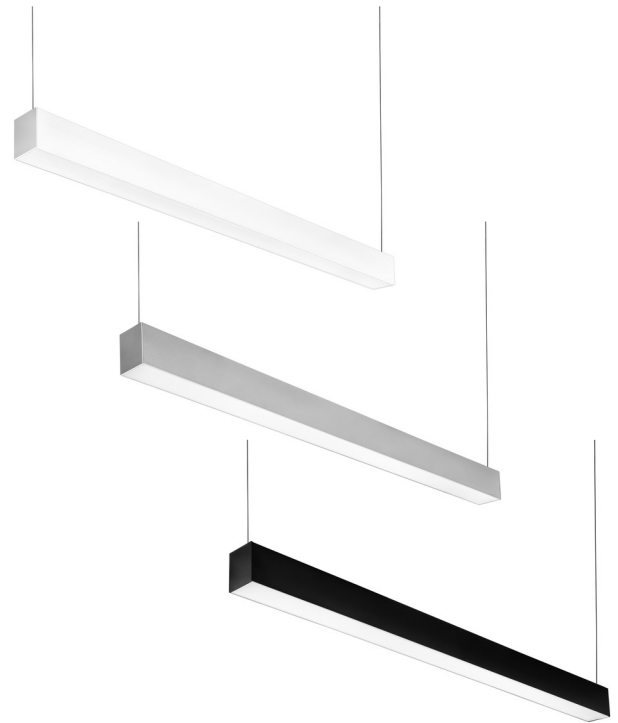

WARRANTY

- 5 year limited warranty; see pltsolutions.com for warranty details

APPLICATIONS

- Storage Areas
- Utility Areas
- Garages
- Workshops
- Hallways

PERFORMANCE SUMMARY

Item #	Total Wattage*	Indirect Lighting Wattage	Direct Lighting Wattage	CCT*	CRI	Dimming	Voltage	Replaces	Finish	Length	DLC #	DLC Level
PLT-90271	50	15	35	3500K/ 4000K/ 5000K	80	0-10V	120-277V	3 Lamp Fluorescent	White	4'	PLTMA4232411	5.1 Standard
PLT-90272	50	15	35	3500K/ 4000K/ 5000K	80	0-10V	120-277V	3 Lamp Fluorescent	Silver	4'	PLTMA4232412	5.1 Standard
PLT-90273	50	15	35	3500K/ 4000K/ 5000K	80	0-10V	120-277V	3 Lamp Fluorescent	Black	4'	PLTMA4232413	5.1 Standard
PLT-90274	65	19.5	45.5	3500K/ 4000K/ 5000K	80	0-10V	120-277V	6 Lamp Fluorescent	White	8'	PLTMA8332411	5.1 Standard
PLT-90275	90	27	63	3500K/ 4000K/ 5000K	80	0-10V	120-277V	8 Lamp Fluorescent	White	8'	PLTMA8432411	5.1 Standard
PLT-90376	65	19.5	49.5	3500K/ 4000K/ 5000K	80	0-10V	120-277V	8 Lamp Fluorescent	Black	8'	N/A	N/A

*See Selectable Table for full breakdown

SELECTABLE TABLE

Wattage	CCT	30% Indirect Lumen Output	70% Direct Lumen Output	Combined Lumen Output	Efficacy
50	3500K	1800	4200	6000	120
	4000K	1860	4340	6200	124
	5000K	1830	4270	6100	122
65	3500K	2340	5460	7800	120
	4000K	2418	5642	8060	124
	5000K	2379	5551	7930	122
90	3500K	3240	7560	10,800	120
	4000K	3348	7812	11,160	124
	5000K	3294	7686	10,980	122

FIXTURE ACCESSORIES

SKU	Description
PLT-90317	2.6 inch Line Joiner - For Use With PLT Solutions LED Suspension Light Fixtures
PLT-90408	8 ft. Suspended Fixture Lens - For Use with 4' PLT LED Suspension Light Fixtures

END-TO-END LINKING

SKU	Number of Fixtures @ 120V	Number of Fixtures @ 277V
PLT-90271	4	8
PLT-90272	4	8
PLT-90273	4	8
PLT-90274	3	6
PLT-90275	2	4
PLT-90276	4	8
PLT-90376	3	6

* Requires PLT-90317, sold separately

DIMENSIONS

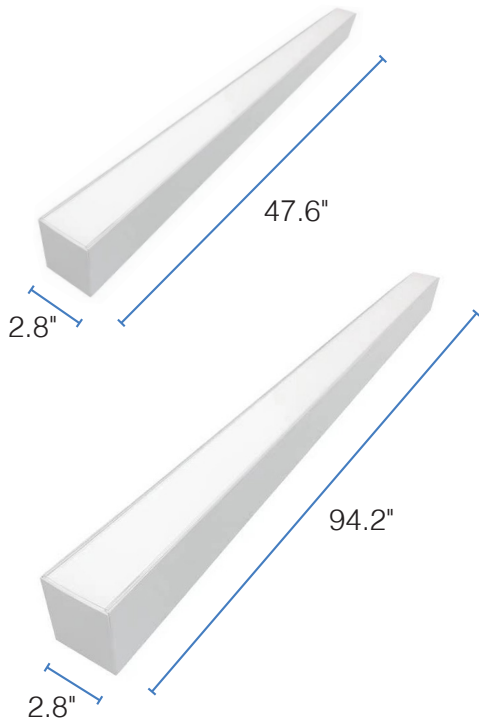

4' DIMENSIONS

Length: 47.6"

Height: 2.8"

Width: 2.8"

Weight: 7.94 lbs

8' DIMENSIONS

Length: 94.2"

Height: 2.8"

Width: 2.8"

Weight: 16.31 lbs

PHOTOMETRICS

PLT-90271 INDIRECT

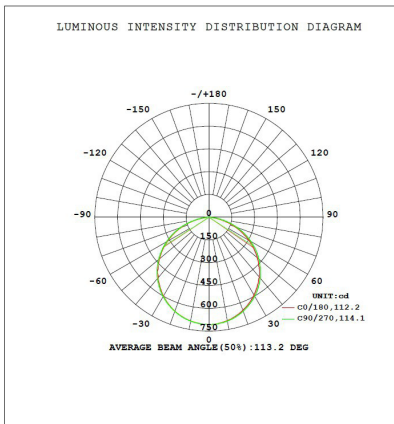

PLT-90272 INDIRECT

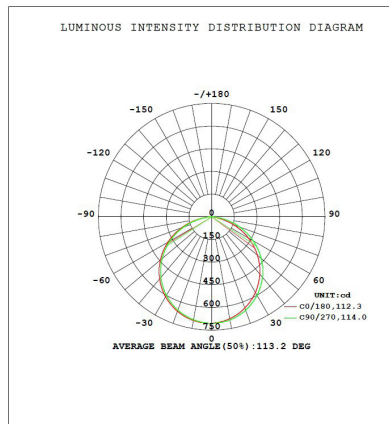

PLT-90273 INDIRECT

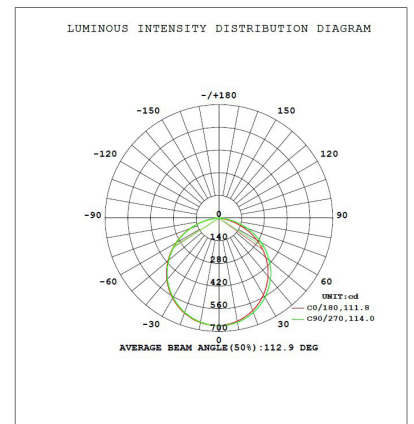

PLT-90271 DIRECT

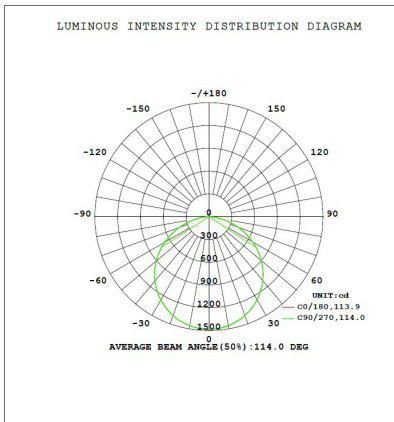

PLT-90272 DIRECT

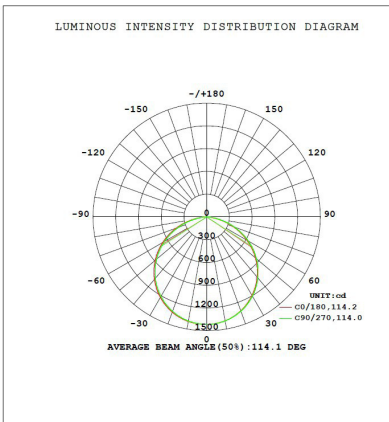

PLT-90273 DIRECT

