

Project Name:	Type:
Part Number:	Date:

# THINFIT 6" COMMERCIAL DOWNLIGHT

## SPECIFICATION FEATURES

- **Mechanical** - Shallow die cast aluminum heat sink with a low profile external driver is ideal for new or remodel construction. Two rugged spring clips allow for both easy installation and field accessibility below the ceiling.
- **Electrical** - 120V voltage, 50/60Hz external driver, dims to 10% using most forward and reverse phase dimmers. Plenum rated cable with quick connect for easy installation. Go to [www.greencreative.com](http://www.greencreative.com) for complete dimmer compatibility list.
- **Optical** - Edge lighting technology featuring a PMMA light guide plate and smooth polycarbonate lens ensures an even light emitting surface. Available in 2700K, 3000K and 4000K with a minimum of 90 CRI.
- **Thermal** - Die cast aluminum heat sink with it's edge lighting design maximizes thermal dissipation. L70 rated lifetime of 50,000 hours. Fixture operating temperature: -4°F to 95°F (-25°C to 35°C)
- **Compliance and warranty** - ETL Listed for wet location. Certified air-tight per ASTM 283-04, IC rated for direct contact with insulation. 5 year parts warranty for complete fixture.



041621



## BENEFITS

- Quick and easy installation with spring action clip
- External driver with quick connector for easy wiring
- Suitable for shallow ceiling applications
- Install almost everywhere with Wet Location, IC and Air-tight ratings
- Edge lighting technology for gentle and smooth diffusion

## APPLICATIONS

- Commercial
- Residential
- Educational
- Hospitality
- Retail

## ORDERING INFORMATION

Series	Size	CRI	CCT	Driver
<input checked="" type="checkbox"/> <b>12NCDL</b> New Construction Downlight 12W	<input checked="" type="checkbox"/> <b>R6DIM</b> 6"	<input checked="" type="checkbox"/> <b>9</b> CRI 90	<input type="checkbox"/> <b>27</b> 2700K <input type="checkbox"/> <b>30</b> 3000K <input type="checkbox"/> <b>40</b> 4000K	<input checked="" type="checkbox"/> <b>EXT</b> 120V - Line voltage dimming

## LINE DRAWINGS

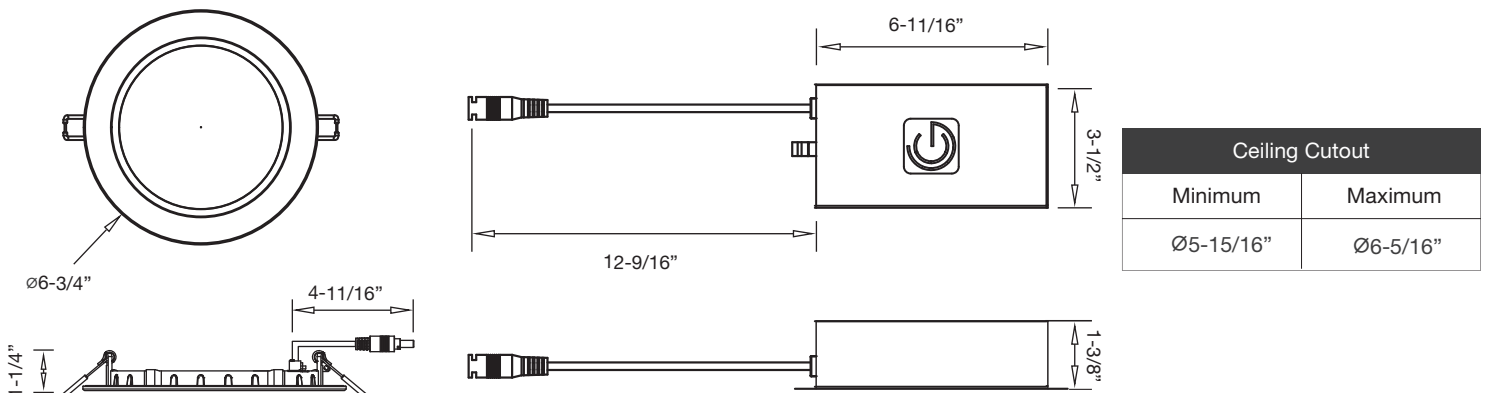



# THINFIT 6" COMMERCIAL DOWNLIGHT

## TECHNICAL INFORMATION

Dimming	Input Voltage	Input Frequency	Input Current	Input Power	THD Power	Power Factor
Forward or Reverse Phase	120V	50 / 60Hz	0.10A	12W	<20%	>0.9

## PHOTOMETRY

12NCDLR6DIM/930/EXT

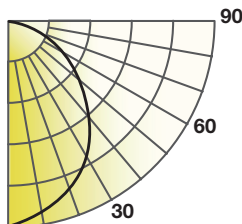

Lumens: 982 lm  
 Power: 12 W  
 Efficacy: 80 lm/W  
 CRI: 90+  
 Spacing Criteria: 1.25  
 Beam Angle: 113°

Candlepower Distribution	
Angle (°)	Average (cd)
0	339
5	337
15	325
25	301
35	267
45	225
55	176
65	124
75	68
85	15
90	0

Initial Footcandles		
Height (ft)	Fc	Diameter (ft)
8	5	24
9	4	27
10	3	30
12	2	36
15	2	45

Zonal Lumen Summary		
Zone	Lumens	%Fixture
0-30	263	27
0-40	433	44
0-60	766	78
0-90	982	100

Coefficient		
2700K	3000K	4000K
0.99	1.00	1.10











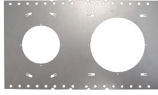
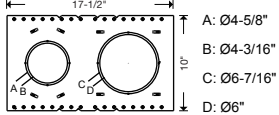
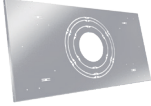
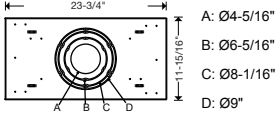

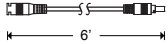

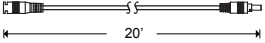

## PERFORMANCE

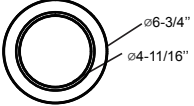
12NCDLR6DIM/9xx/EXT

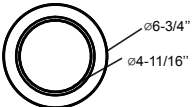
	2700K	3000K	4000K
CCT	2700K	3000K	4000K
Lumens	969	982	1078
LPW	79	80	86

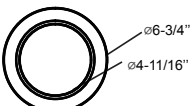

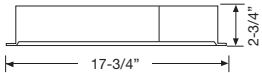
# THINFIT 6" COMMERCIAL DOWNLIGHT

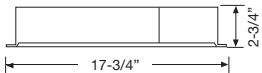
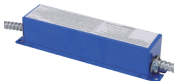
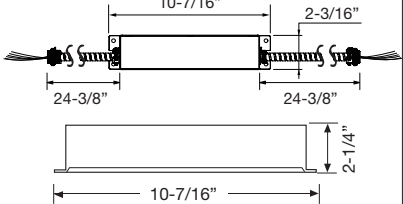
ACCESSORY ORDERING INFORMATION				
Product	Model	Description	Pictures	Dimenions
98280	NCDL46RPLATE	4" & 6" THINFIT EXT Series New Construction Plate for Stud/Joist Mounting		
98501	NCPLATE/T4689	New Construction or Remodel Plate for T-Grid Ceilings		
98236	NCDLCON6	THINFIT EXT 120V - 6 foot extension cable		
98237	NCDLCON20	THINFIT EXT 120V - 20 foot extension cable		
97848	DLNC6GOOF/R	6" THINFIT EXT Series GOOF RING		
98348	NCDLR6TRIMBL	6" THINFIT EXT Series Black Trim		
98349	NCDLR6TRIMBN	6" THINFIT EXT Series Brushed Nickel Trim		
98350	NCDLR6TRIMBZ	6" THINFIT EXT Series Bronze Trim		
58012	35EMINVERTER	35W Emergency Inverter (Field Installation)		
58013	35EMINVERTER/CEC	California Title 20 Compliant 35W Emergency Inverter (Field Installation)		
98003	23EMDRIVER	California Title 20 Compliant 23W Emergency LED Driver (Field Installation)		



# THINFIT 6" COMMERCIAL DOWNLIGHT

## ORDERING GUIDE

Product	Model
98107	12NCDLR6DIM/927/EXT
98108	12NCDLR6DIM/930/EXT
98109	12NCDLR6DIM/940/EXT

Note: All rights reserved. All sizes and specifications are subject to change at any time without notice.