

Project Name:	Type:
Part Number:	Date:

THINFIT 6" COMMERCIAL DOWNLIGHT

SPECIFICATION FEATURES

- **Mechanical** - Shallow die cast aluminum heat sink with a low profile external driver is ideal for new or remodel construction. Two rugged spring clips allow for both easy installation and field accessibility below the ceiling.
- **Electrical** - Externally mounted driver, 120 - 277V voltage, 50/60Hz, 0 - 10V dimming to 10%. Quick connect electrical connect in metal clad cable. Go to www.greencreative.com for complete dimmer compatibility list.
- **Optical** - Edge lighting technology featuring a PMMA light guide plate and smooth polycarbonate lens ensures an even light emitting surface. Available in 3000K, 3500K and 4000K with a minimum of 90 CRI.
- **Thermal** - Die cast aluminum heat sink with its edge lighting design maximizes thermal dissipation. L70 rated lifetime of 50,000 hours. Fixture operating temperature: -4°F to 95°F (-25°C to 35°C)
- **Compliance and warranty** - ETL Classified and Listed for wet location. Certified air-tight per ASTM 283-04, IC rated for direct contact with insulation. 5 year parts warranty for complete fixture.



041621



BENEFITS

- Quick and easy installation with spring action clip
- External driver with quick connector for easy wiring
- Suitable for shallow ceiling applications
- Install almost everywhere with Wet Location, IC and Air-tight ratings
- Edge lighting technology for gentle and smooth diffusion

APPLICATIONS

- Commercial
- Residential
- Educational
- Hospitality
- Retail

ORDERING INFORMATION

Series	Size	CRI	CCT	Driver
<input checked="" type="checkbox"/> 12NCDL New Construction Downlight 12W	<input checked="" type="checkbox"/> R6DIM 6"	<input checked="" type="checkbox"/> 9 CRI 90	<input type="checkbox"/> 30 3000K <input type="checkbox"/> 35 3500K <input type="checkbox"/> 40 4000K	<input checked="" type="checkbox"/> 277V / EXT 120 - 277V, 0-10V Dimmable to 10%

LINE DRAWINGS

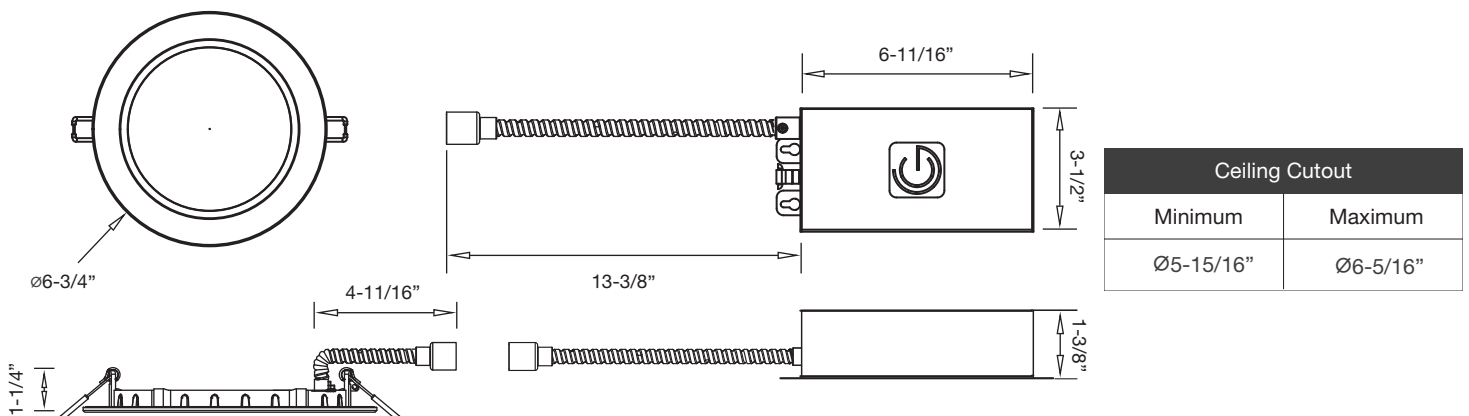



THINFIT 6" COMMERCIAL DOWNLIGHT

TECHNICAL INFORMATION

Dimming	Input Voltage	Input Frequency	Input Current	Input Power	THD Power	Power Factor
0-10V	120-277V	50 / 60Hz	0.10A	12W	<20%	>0.9

PHOTOMETRY

12NCDLR6DIM/935/277V/EXT

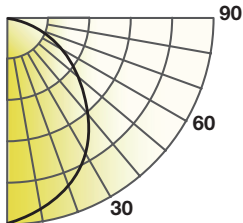

Lumens: 1056 lm
 Power: 12 W
 Efficacy: 91 lm/W
 CRI: 90+
 Spacing Criteria: 1.25
 Beam Angle: 100°

Candlepower Distribution	
Angle (°)	Average (cd)
0	364
5	362
15	350
25	324
35	289
45	243
55	192
65	136
75	77
85	20
90	0

Initial Footcandles		
Height (ft)	Fc	Diameter (ft)
8	6	24
9	4	27
10	4	30
12	3	37
15	2	46

Zonal Lumen Summary		
Zone	Lumens	%Fixture
0-30	282	27
0-40	463	44
0-60	821	78
0-90	1056	100











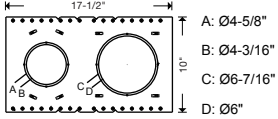
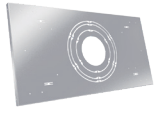
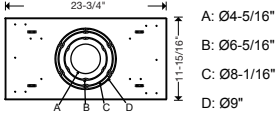

Coefficient		
3000K	3500K	4000K
0.96	1.00	1.01

PERFORMANCE

12NCDLR6DIM/9xx/277V/EXT

	3000K	3500K	4000K
CCT	3000K	3500K	4000K
Lumens	1017	1056	1069
LPW	88	91	93

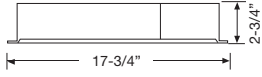
THINFIT 6" COMMERCIAL DOWNLIGHT

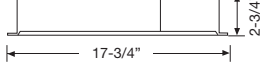
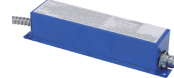
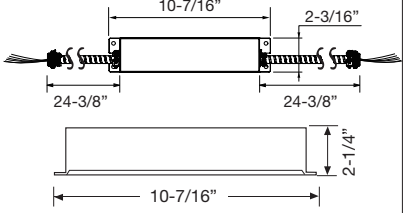
ACCESSORY ORDERING INFORMATION				
Product	Model	Description	Pictures	Dimenions
98280	NCDL46RPLATE	4" & 6" THINFIT EXT Series New Construction Plate for Stud/Joist Mounting		 A: $\varnothing 4-5/8"$ B: $\varnothing 4-3/16"$ C: $\varnothing 6-7/16"$ D: $\varnothing 6"$
98501	NCPLATE/T4689	New Construction or Remodel Plate for T-Grid Ceilings		 A: $\varnothing 4-5/16"$ B: $\varnothing 6-5/16"$ C: $\varnothing 8-1/16"$ D: $\varnothing 9"$
97848	DLNC6GOOF/R	6" THINFIT EXT Series GOOF RING		 $\varnothing 8-5/8"$ $\varnothing 6-1/4"$
98348	NCDLR6TRIMBL	6" THINFIT EXT Series Black Trim		 $\varnothing 6-3/4"$ $\varnothing 4-11/16"$
98349	NCDLR6TRIMBN	6" THINFIT EXT Series Brushed Nickel Trim		 $\varnothing 6-3/4"$ $\varnothing 4-11/16"$
98350	NCDLR6TRIMBZ	6" THINFIT EXT Series Bronze Trim		 $\varnothing 6-3/4"$ $\varnothing 4-11/16"$
58012	35EMINVERTER	35W Emergency Inverter (Field Installation)		 $17-3/4"$ $2-3/4"$
58013	35EMINVERTER/CEC	California Title 20 Compliant 35W Emergency Inverter (Field Installation)		 $17-3/4"$ $2-3/4"$
98003	23EMDRIVER	California Title 20 Compliant 23W Emergency LED Driver (Field Installation)		 $10-7/16"$ $2-3/16"$ $24-3/8"$ $24-3/8"$ $2-1/4"$ $10-7/16"$

ORDERING GUIDE	
Product	Model
98217	12NCDLR6DIM/930/277V/EXT
98218	12NCDLR6DIM/935/277V/EXT
98219	12NCDLR6DIM/940/277V/EXT

Note: All rights reserved. All sizes and specifications are subject to change at any time without notice.