

legrand®

Wattstopper®

Lighting Control Panel

User Manual

No: 24270 – 11/16 rev. 1

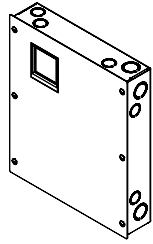

Catalog Number: LC8-120/277

Country of Origin: Made in China

SPECIFICATIONS

Power input	120/277 VAC; 50/60 Hz
Accessory power	500 mA at 24 VDC
Switch inputs with screw terminals;	
Used with 3-wire momentary, 2-wire momentary or maintained with pilot light output	
Relay grouping	Configurable to switches through touchscreen user interface
Panel weight	8.1 lbs. (without relays)
Relays	Modular; dual 1-pole or single 2-pole
LCDP-1 relay ratings	
Ballast/LED Driver	20 A @ 208V
Ballast/LED Driver	20 A @ 240V/480V (2 Phase)
Motor	1 HP @ 208V/240V
Short Circuit Current Rating	14kA AIC @ 277 VAC
LCSP-2 relay ratings	
Incandescent	20 A @ 120V/277V
Ballast/LED Driver	20 A @ 120V/277V
Motor	1/2 HP @ 120V
Short Circuit Current Rating	14kA AIC @ 277 VAC
Relay weight	LCDP-1: 0.49 lbs., LCSP-2: 0.37 lbs.
Operating conditions	For indoor installation only
.....	32-122oF (0-50oC); 5-95% RH noncondensing
UL and CUL listed	

CONTENTS

Specifications	1
Description and Operation	3
Quick Setup	3
Interior Lighting.....	3
Exterior Lighting	7
Installation and Setup	12
Installing the Panel.....	12
Wiring SPST Loads	13
Wiring DPST Loads.....	14
Connecting Low Voltage Switches to the LC8	15
Connecting Occupancy Sensors and Photocells	16
Connecting an EM24-D Exterior Photocell to the LC8.....	16
Operation Guide	16
Theory of Operation	16
Icon Definitions.....	17
Getting Started	18
Relays Override.....	19
Setup Menus	20
Assigning Relays to an Input.....	23
Assigning Relays to Channels	24
Assigning Schedules to Channels.....	25
Schedules.....	26
Sound Options	37
Returning the LC8 Panel to Factory Default Settings	38
Troubleshooting	39
Lighting Control Panel Circuit & Program Documentation Form.....	40

DESCRIPTION AND OPERATION

The LC8 Lighting Control Panel is an easy to use lighting controller intended for applications where automated lighting control is required. Lighting control can be configured to respond to scheduling, photocell input, astronomic input, switch input and/or combinations of these. The LC8 is suitable for controlling interior or exterior lighting, and can be configured with either single pole single throw relays or double pole single throw relays for multi-pole circuits. Configuration changes are easily made through the integrated touch screen that is always accessible through the panel cover.

QUICK SETUP

The LC8 is designed to allow very flexible automated lighting control, yet can be set up to do basic automatic control functions very simply. It is assumed that your unit is installed and wired before using this Quick Setup. The steps for basic control are as follows:

Interior Lighting

The following example provides quick setup instructions for assigning interior lighting to a schedule. The basic steps are:

1. Set Time and Date.
2. Assign Relays to a Channel.
3. Set a Schedule.
4. Assign Channel to your Schedule.

Step 1: Set Time and Date

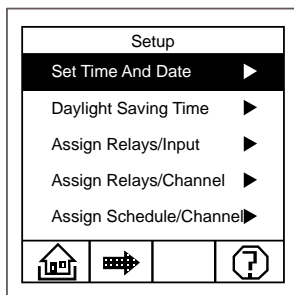
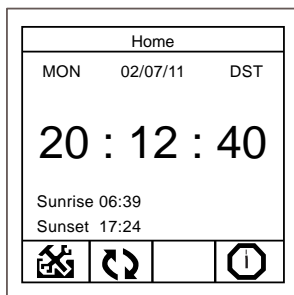

Select Setup from Home menu. 

Touch Set Time and Date.

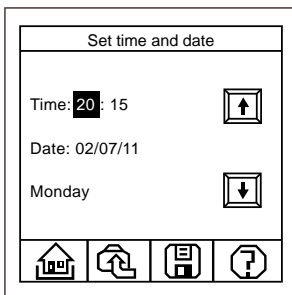

Touch Hour to highlight. Use up and down arrows to adjust time. Repeat for setting minutes and date.

Select  Save

Step 2: Assign Relays to a Channel.

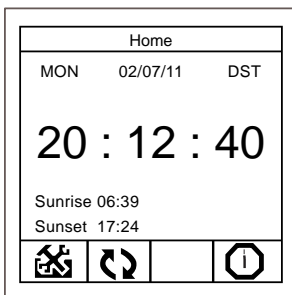

Select Setup  from Home menu.

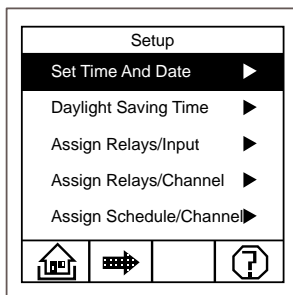

The Setup menu displays.

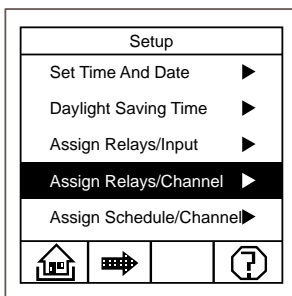

Touch Assign Relays/Channels to highlight. Touch again to enter relay assignment menu.

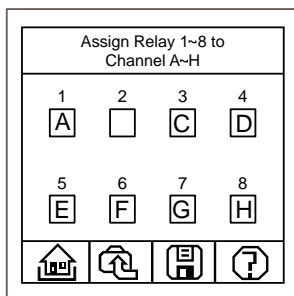

Select relay number to highlight. Touch relay number again to select Channel A. Repeat above for all desired relays. Select Save

NOTE: In the example, only Relay 1 controls interior lighting and has been assigned to Channel A. Your setup may require more than one relay to be assigned to Channel A.

Step 3: Set a Schedule.

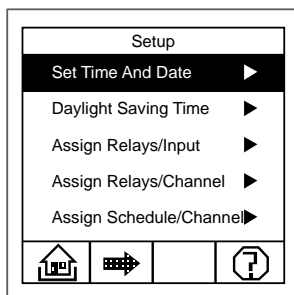
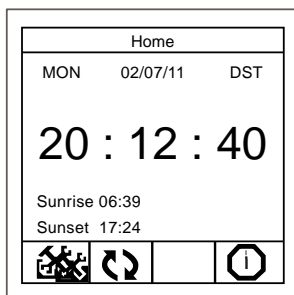

Select Setup from Home menu. 

Select Next. 

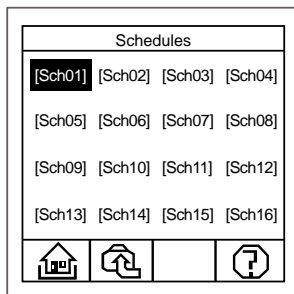
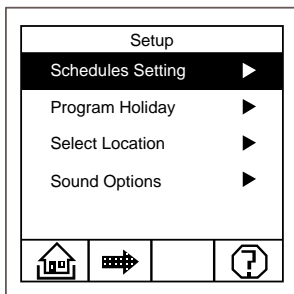

Touch Schedules Setting to display Schedule # setup menu.

Select (Sch01). Touch again.

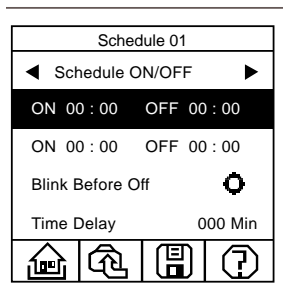
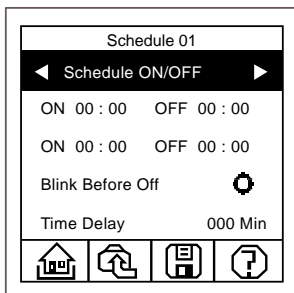

Ensure "Schedule ON/OFF" is highlighted.

Touch the first ON/OFF setting to highlight. Touch again to display Schedule Time screen.

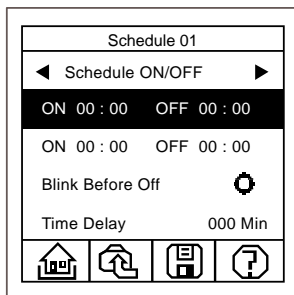
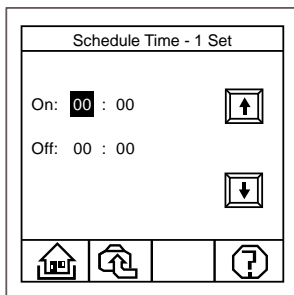

Touch hours (and minutes if desired) to highlight. Use up and down arrows to select times.

Select Save to save settings



Select Back



Step 4: Assign Channel to Your Schedule.

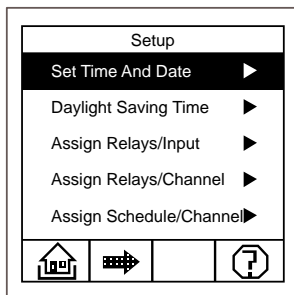
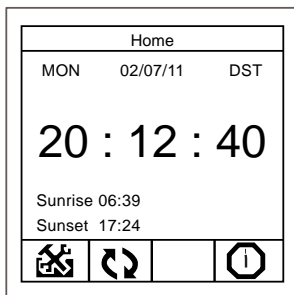

Select Setup  from Home menu.

Setup Menu displays

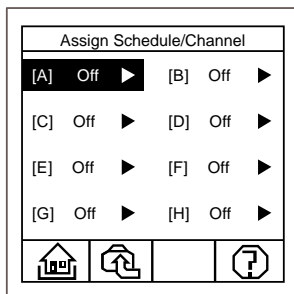
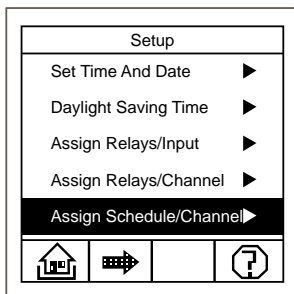

Select Assign Schedule/Channel. Touch again.

The Assign Schedule/Channel menu displays. Select Channel A.

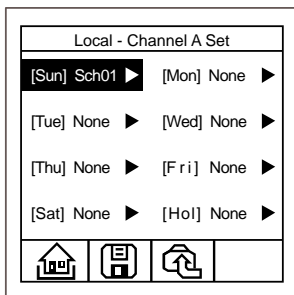

Enter Sch01 to each day of the week desired.

Select Save. 

RESULT: Interior lighting will turn **ON** at the scheduled **ON** time, and turn **OFF** at the scheduled **OFF** time.

Exterior Lighting

The following example provides basic instructions for configuring exterior lighting to respond to astronomical inputs. The basic steps are:

1. Set Time and Date (unless previously set up)
2. Enter Geographic Location
3. Assign Relays to a Channel
4. Set a Schedule
5. Assign Channel to your Schedule

Step 1: Set Time and Date.

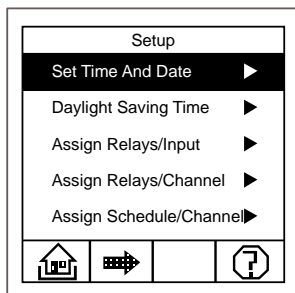
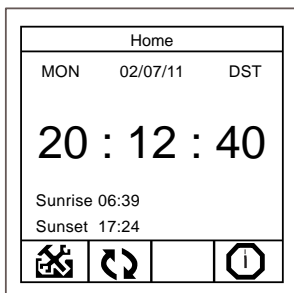

Select Setup from Home menu. 

Touch Set Time and Date.

Step 2: Enter Geographic Location.

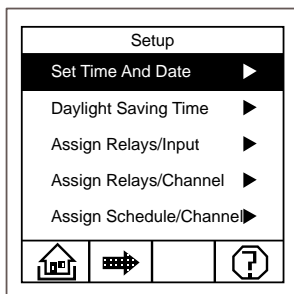
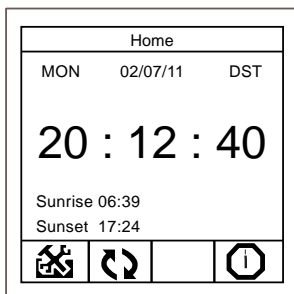

Select Setup from Home menu. 

Select Next. 

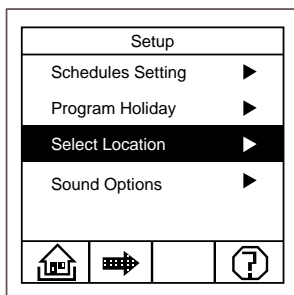
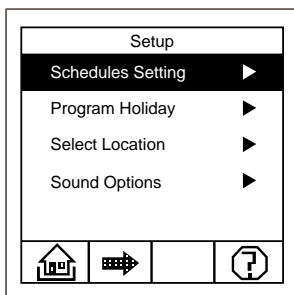

Schedules Setting displays

Touch Select Location.
Touch again for Location Set.

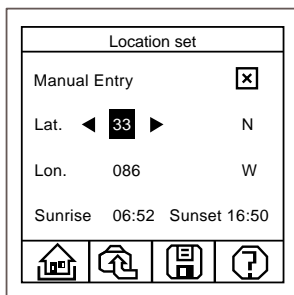
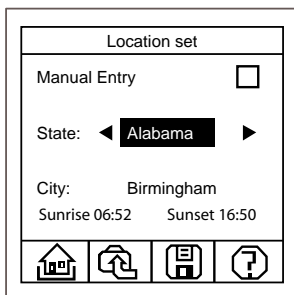

Scroll through entries to select state.
Scroll through entries to select city.

Select Manual Entry. Enter Lat. and Lon. if your location is not in lists.

Select Save. 

Select Save. 

Step 3: Assign Relays to a Channel.

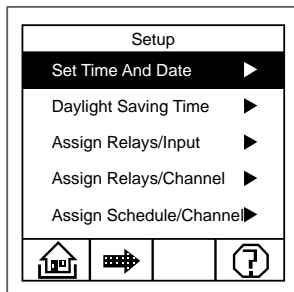
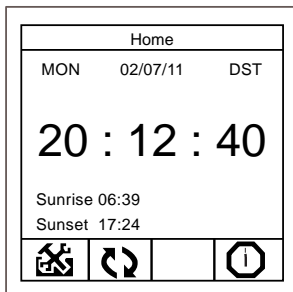

Select Setup from Home menu. 

Setup menu displays

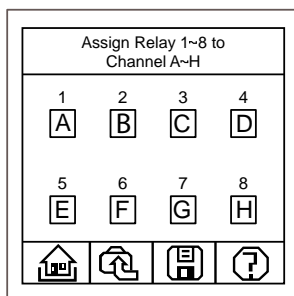
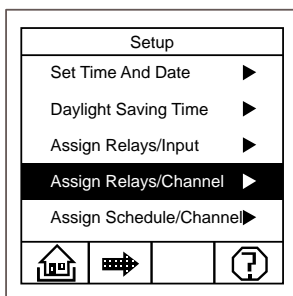

Touch Assign Relays/Channels to highlight.
Touch again to enter relay assignment menu.

Select relay # to highlight. Touch relay number again to select Channel B. Repeat above for all desired relays

Select Save. 

Step 4: Set a Schedule.

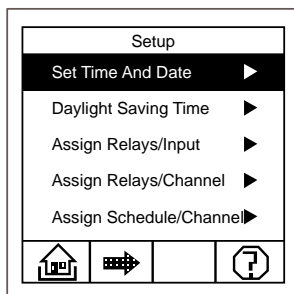
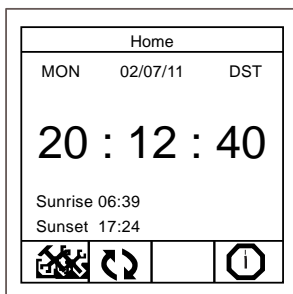

Select Setup from Home menu. 

Select Next. 

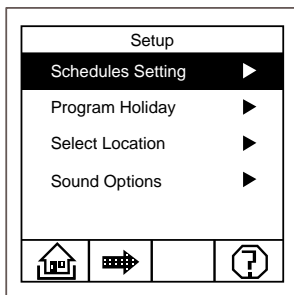

Touch Schedules Setting to display Schedule# setup screen

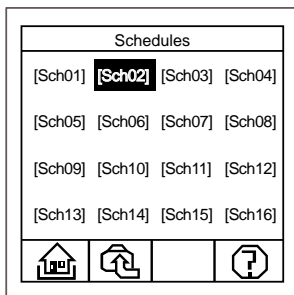

Select (Sch02). Touch again.

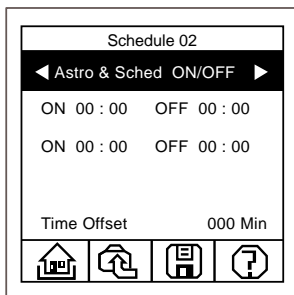

Ensure "Astro & Sched ON/OFF" is highlighted.

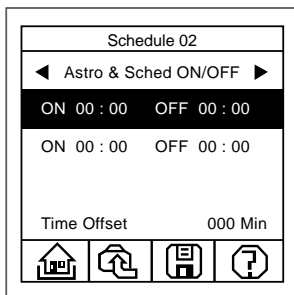

Touch the first ON/OFF setting to highlight.

Step 5: Assign Channel to Your Schedule.

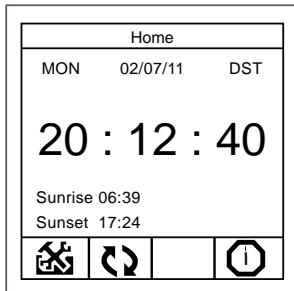

Select Setup from Home menu.

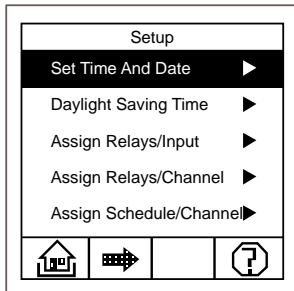

Setup menu displays



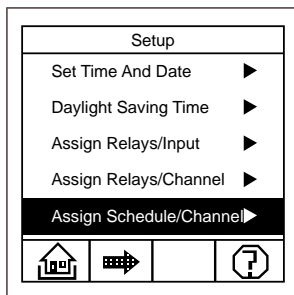

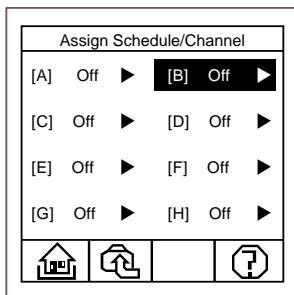

Select Assign Schedule/Channel. Touch again.

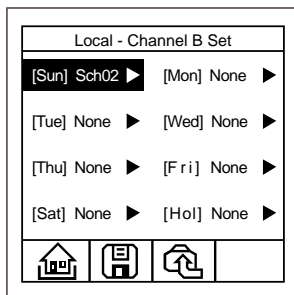

The Assign Schedule/Channel menu displays. Select Channel B.



Enter Sch02 to each day of the week desired.

Select Save. 

RESULT: The exterior lighting will turn **ON** at sunset and turn **OFF** at sunrise, as well as turn **ON** and **OFF** according to your schedule.

NOTE: The above will provide basic lighting control. More complex setups of operation can be achieved through the use of additional schedules and/or accessories such as low voltage wall switches, photocells, or occupancy sensors.

INSTALLATION AND SETUP

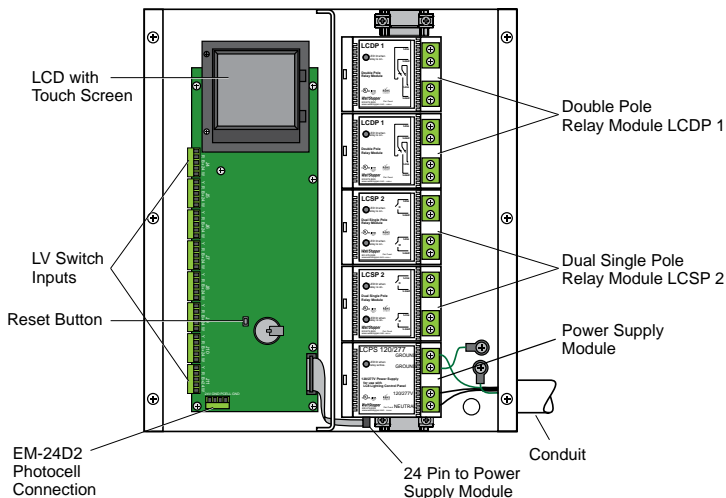

Fig. 1: LC8 Components

Installing the Panel

The LC8-120/277 enclosure is designed for surface wall mounting. Attach the enclosure to the wall using hardware appropriate for the wall type and material (not included).

The relays for the LC8 are modular and may have shipped separately from the enclosure. The relay modules are designed for DIN rail mounting. To install the relay modules:

1. Place the module over the DIN rail with the terminal blocks to the right.
2. First, hook the terminal side of the module DIN rail track onto the DIN rail.
3. Then, lower the module and press down until the opposite side of the module clicks to the DIN rail.
4. After the module is attached to the DIN rail, slide the module down the DIN rail until it makes contact with the power supply module.
5. Carefully push the relay module against the power supply module until the multi-pin connector on the relay module fully mates with the matching connector on the power supply module.
6. Repeat this process for all relay modules that are to be installed in the enclosure.
7. When properly installed, there should be approximately 1/16 inch space between each module.
8. Connect the hot feed wire (120 or 277 volts) to the "L" terminal block on the power supply module.

9. Connect the neutral feed wire to the “N” terminal block on the power supply module.
10. Connect the building source supply earth ground wire to earthing ground post. Use the other grounding post to bond power supply module to earth ground.

CAUTION: This unit contains two earthing posts for grounding. Only one dedicated post shall be used for the building source supply ground and is not to be used or shared with any other conductors. The other post can be used for earth bonding of internal components.

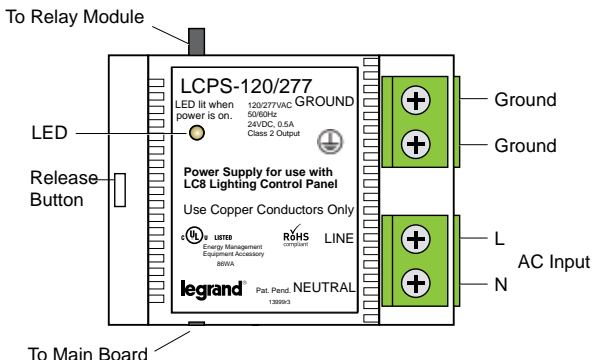

Fig. 2: Power Supply

Energize the feed circuit and note the following conditions:

1. The touch screen display back light will illuminate for a short time.
2. The green LED on the power supply module will illuminate and remain lit.
3. Three red LEDs on the main PC board will illuminate and remain lit.
4. If any of the above conditions do not occur, refer to the troubleshooting section, otherwise de-energize the feed circuit and continue with the installation.

Wiring SPST Loads

1. Connect each load to the Load terminal on a relay module.
2. Connect the Line terminal for each relay to an appropriate source of power to control the load.
3. Note that the LCSP-2 relay module contains two single pole relays that are independently controlled by the panel. Thus, each LCSP-2 has two Input/Output terminal blocks.

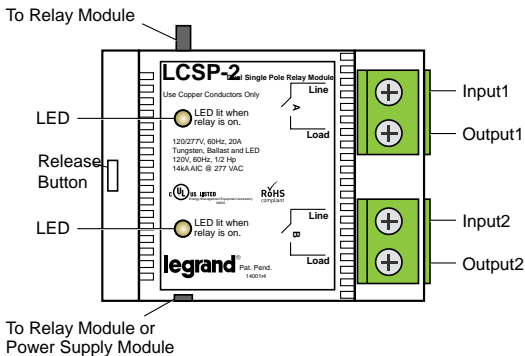

Fig. 3: Relay for SPST Loads

Wiring DPST Loads

1. Connect the load wires to the Output 1 and Output 2 terminal blocks on the LCDP-1 double pole relay module.
2. Connect the double pole circuit to be controlled to the Input 1 and Input 2 terminal blocks.
3. Note that the LCDP-1 relay module contains one double pole relay. Thus, all connections to each LCDP-1 relay module are for the same load.

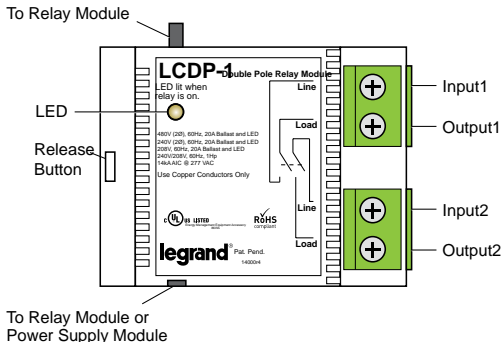
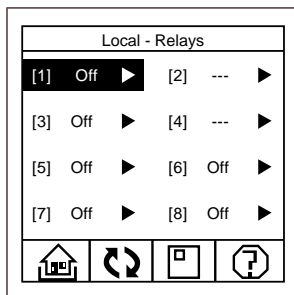
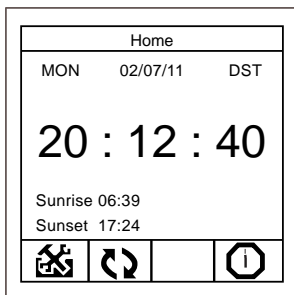

Fig. 4: Relay for DPST Loads

1. Note that the load neutral wires are not connected to the relay modules.
2. Check all load wires for shorts prior to energizing the panel power supply feed or the load feed breakers.
3. Energize the LC8 panel power supply and again note the conditions indicated previously.
4. Touch the <Rotate> icon on the Home page of LCD screen until the Relays screen is displayed.



5. Touch each relay to toggle the relay on and off.
6. Confirm that all of the relays switch and that the loads turn on and off.

Connecting Low Voltage Switches to the LC8

The LC8 will operate with a variety of low voltage switch types including 2 wire momentary, 3 wire momentary, or maintained contact. Switches may be connected to the input terminal blocks 1- 8 and configured to control relays or channels. Connect switches per the following diagrams:

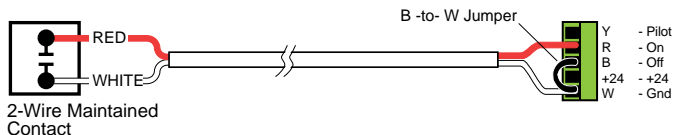
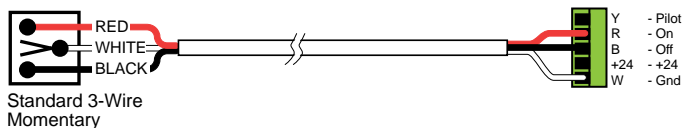
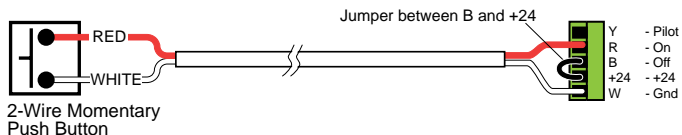

Fig.5: Low Voltage Switches

Connecting Occupancy Sensors and Photocells

Any WattStopper low voltage occupancy sensor that is intended to work with a power pack can be used as an input to the LC8 to control relays. Connect the occupancy sensor per the following diagram:

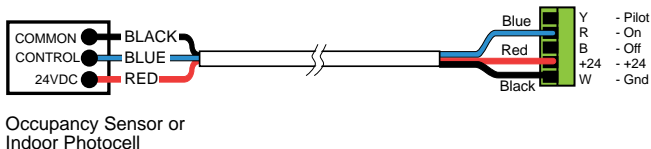
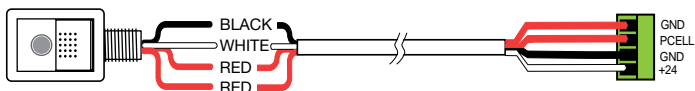

Fig.6: Connecting Occupancy Sensors

Connecting an EM24-D Exterior Photocell to the LC8



OPERATION GUIDE

Theory of Operation











The LC8 lighting control panel is designed to automatically control interior or exterior lighting based on a weekly schedule, astronomic time calculation, or input from an accessory photocell. Automatic operation can be augmented or overridden through the use of accessory low voltage wall switches. Automatic operation is conveniently user-defined by selecting an operating mode scenario that will automatically combine the clock, astronomic, and photocell operations to produce the desired sequence of operation for each day of the week.

The LC8 supports the control of both single pole (120 or 277 volts) and double pole lighting circuits (240, 208, or 480 volts) through the selection of either SPST or DPST relay modules. Modules are available as either a single double pole relay or two independent single pole relays. A maximum of 4 relay modules can be installed in the LC8 panel for a total of 8 circuits of control. Input power to the LC8 panel can be supplied at either 120 or 277 volts.

All user interface with the LC8 is through the illuminated touch screen. There are no pushbuttons or other controls provided except for a reset button located above the battery inside the enclosure.

Icon Definitions

The following is a list of all icons and their functions.

Icon	Function
	Return to the Home screen with <Home> icon.
	Rotate through Input, Relay and Channel screens with <Rotate> icon.
	Enter the setup mode with <Setup> icon.
	Choose a panel with <Panel Select> icon.
	Display Help with <Help> icon.
	Save settings with <Save> icon.
	Go back with <Back> icon
	Go to the next screen with <Next> icon.
	Go to Holiday set range screen with <Range> icon.
	Get hardware, firmware versions, and model with <Information> icon.

Getting Started

Upon initial startup, the Logo screen displays:



Touch the screen to display the Home menu:

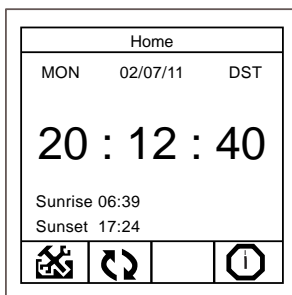

The Home screen always displays the current day of the week, date, Daylight Savings Time (DST) status and the time of day in 24 hour format. The sunrise and sunset times are also displayed based on the astronomic location settings in the panel. From most other screens you can return to the home screen by touching the <Home> icon:



From the Home screen you can rotate through the status screens and back to Home by touching the <Rotate> icon:



Enter the setup mode by touching the <Setup> icon:



Relays Override

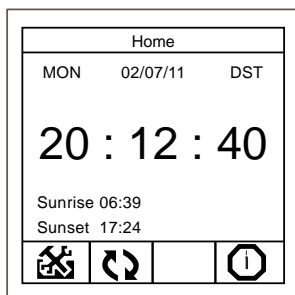

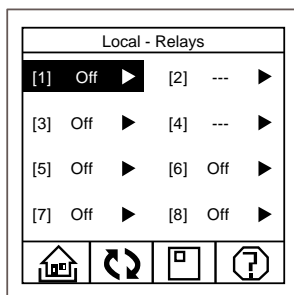

Touch Rotate to display the Local Relays screen. 

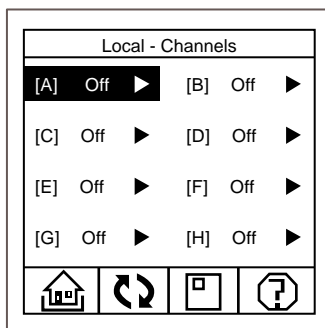

Touch a Relay to toggle the relay ON and OFF.

Note that two pole relays will be controlled by the odd number, or first, relay position. The even number position will be blank. For example, a two pole relay module installed in position #1 on the DIN rail will be controlled by the Relay #1 display. Relay #2 will be shown as a "---" position on the screen.



Touch Rotate to bring up the Channels screen. 

There are three states of a channel depending on the states of assigned relays: **ON**, **OFF** and **MIX** (when there is a mixture of **ON** and **OFF** relays).

The relays that are assigned can be toggled on and off. By default, the relays are assigned to the channels on a one-to-one basis. That is, relay one to channel A, relay 2 to channel B, etc. See the section on Assign Relays/Channel under Setup to change the default assignment of relays to the channels. If channels are not assigned, a "---" will display.

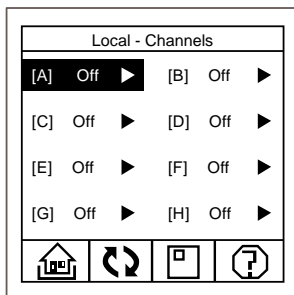

Touch Rotate to bring up the Inputs screen. 

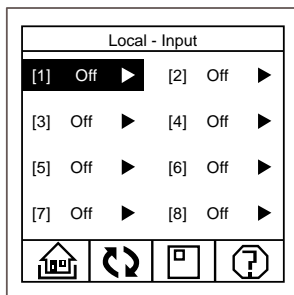

Touch the input number to toggle the relay(s) programmed to the input ON and OFF.

Setup Menus

There are three setup menus that you can cycle through:

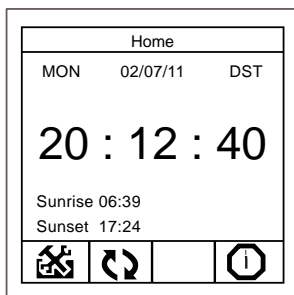

Select Setup from Home menu. 

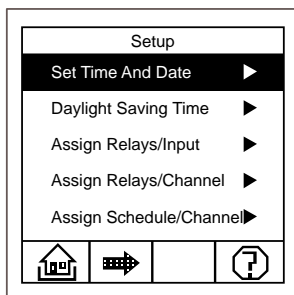

Select Next. 

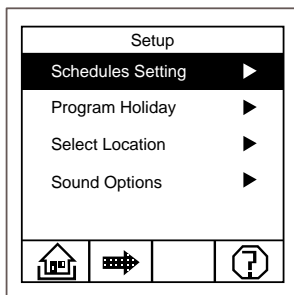

Second Setup menu displays .

Select Next. 

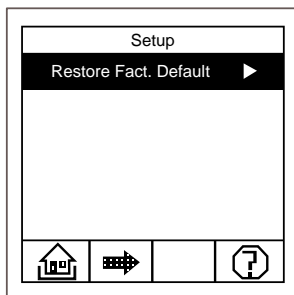

Third Setup menu displays.

Setting Time and Date

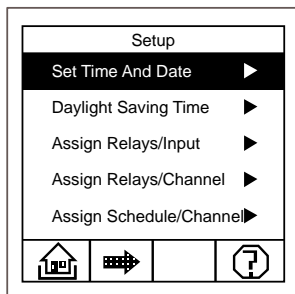
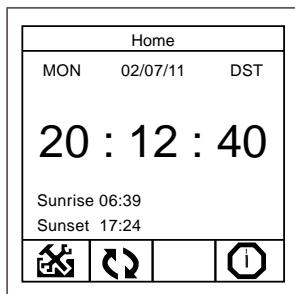

Select Setup from Home menu. 

Touch Set Time and Date.

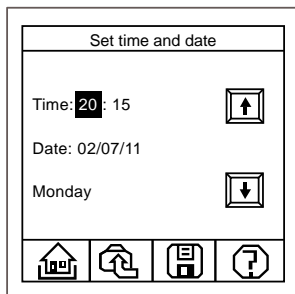

Touch Hour to highlight. Use up and down arrows to adjust time. Repeat for setting minutes and date.

Select  Save

Daylight Saving Time

The LC8 can be set to follow or not follow DST.

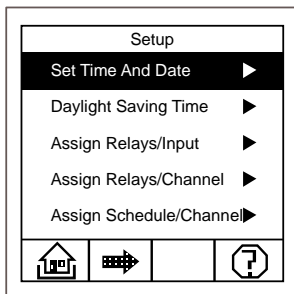
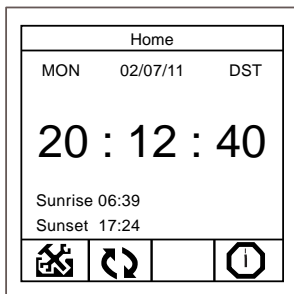

Select Setup from Home menu. 

The Setup Menu Displays

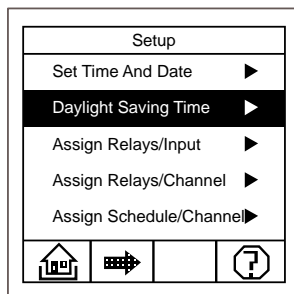

Select Daylight Saving Time.

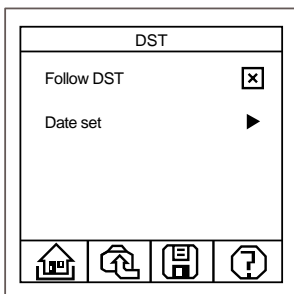

Touch the check box to activate or deactivate DST feature.

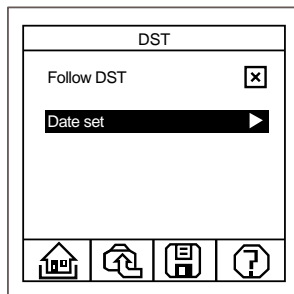

Touch Date set twice to display DST Date Set screen.

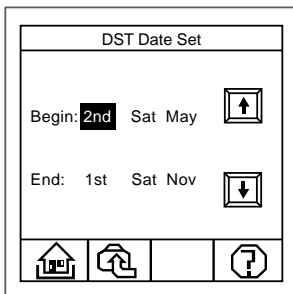

Touch desired value. Use up and down arrows to change value.

Assigning Relays to an Input

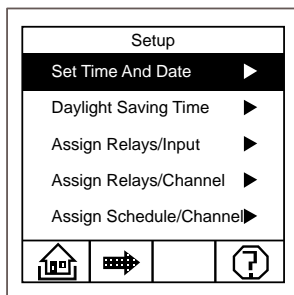
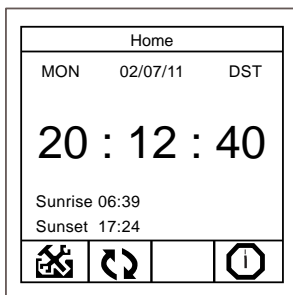

Select Setup from Home menu.



The Setup Menu Displays

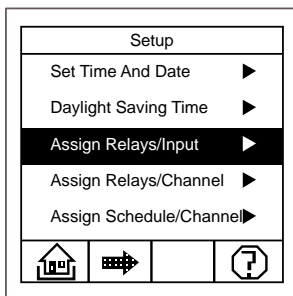

Touch Assign Relays/Input.
Touch again.

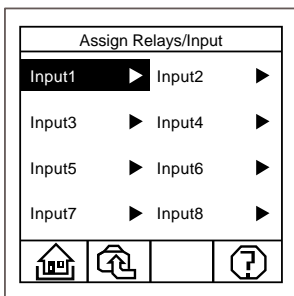

The Assign Relays/Input menu displays. Touch the input number to program.

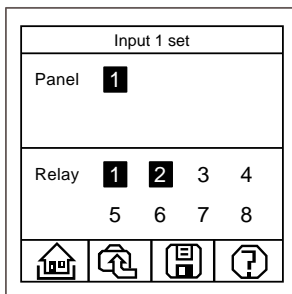

The Input number Set screen displays relays set to this input.

Select Save



Assigning Relays to Channels

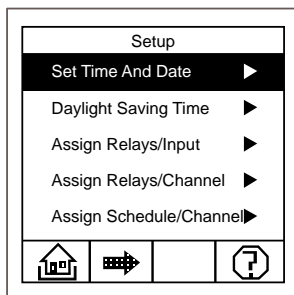
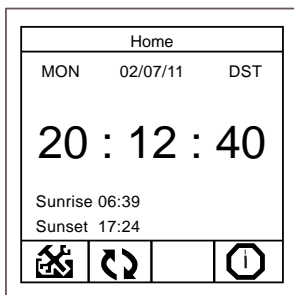

Select Setup from Home menu.



The Setup Menu Displays

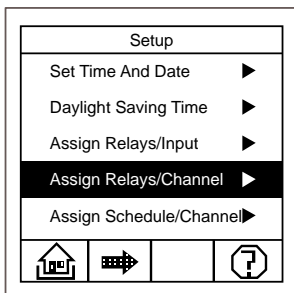

Touch Assign Relays/Channels to highlight. Touch again to enter relay assignment menu.

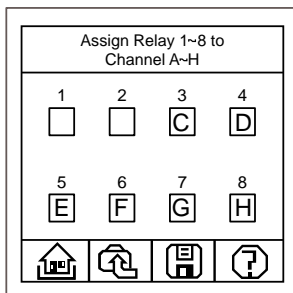

Select relay number to highlight. Touch relay number again to select Channel A. Repeat above for all desired relays.

Select Save

NOTE: If dashes (--) and not boxes are shown in your relay assignment menu, you have an SPST installed instead of a DPST:

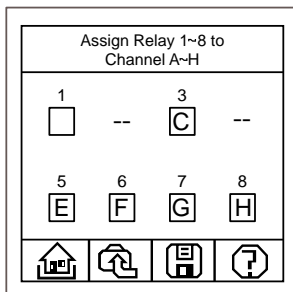

Assigning Schedules to Channels

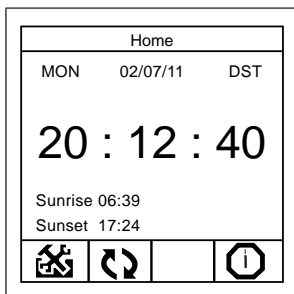

Select Setup from Home menu. 

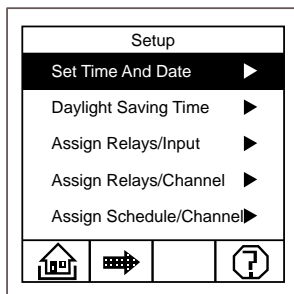

The Setup Menu Displays

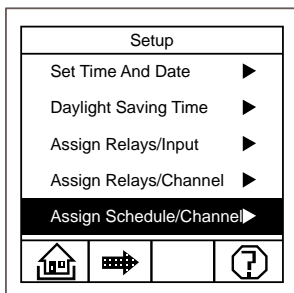

Touch Assign Schedule/Channel.
Touch again.

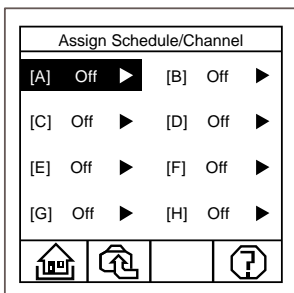

The Assign Schedule/Channel menu displays.
Select Channel A.

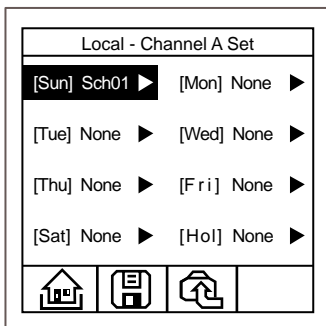

Enter Sch01 to each day of the week desired.

Select Save 

Schedules

Schedule ON/OFF

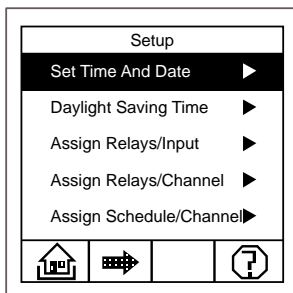
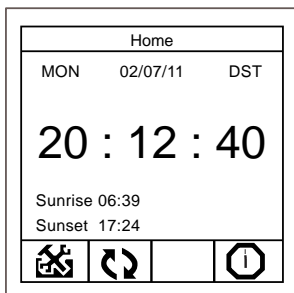

Select Setup from Home menu. 

Select Next. 

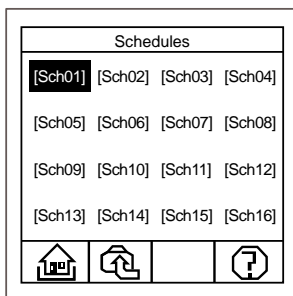
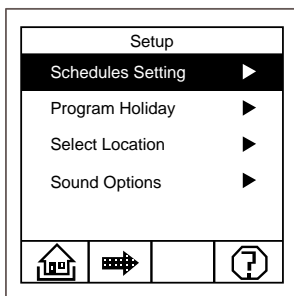

Touch Schedules Setting to display Schedule # Setup menu.

Select (Sch01). Touch again.

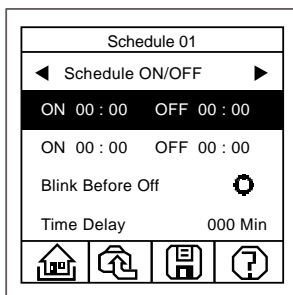
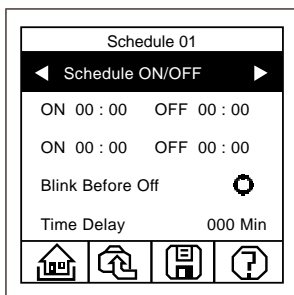

Select Schedule ON/OFF by touching arrows and cycling through the choices.

Touch ON/OFF to display Schedule Time menu.

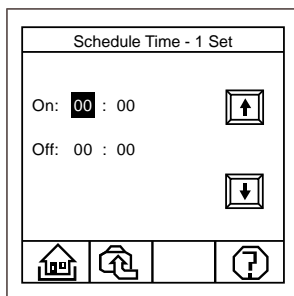

Use up and down arrows to select times.

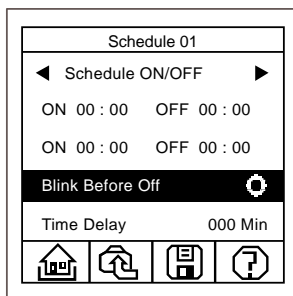

If the Blink Before Off feature is to be active for this schedule:
Touch the Blink Before Off display.

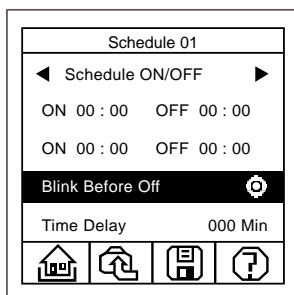

Then touch the circle display.
A dot indicates the blink feature is active. No dot indicates that the blink feature is not used for this schedule.

If a wall switch will be used with the lighting controlled by this schedule, you will need to set a Time Delay for the switch.

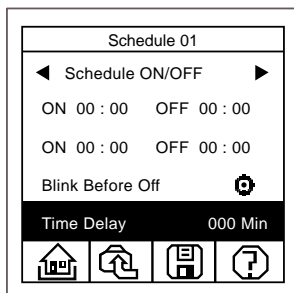

Touch time delay to display Time Delay screen.

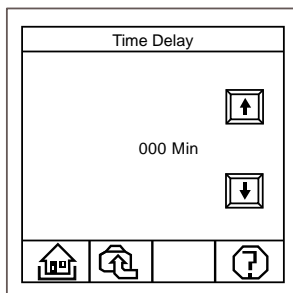

Use up and down arrows to set number of minutes between OFF sweeps.

Manual ON/Schedule OFF

Time settings will turn the lighting **OFF**. Lighting will be turned **ON** manually. This setting works similar to Schedule **ON/OFF**, except that the **ON** time setting does not turn the lighting **ON**. It determines the time when the Time Delay feature is deactivated.

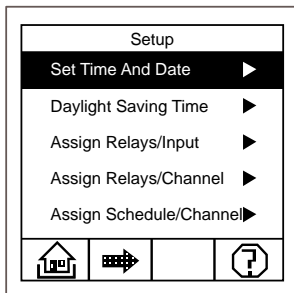
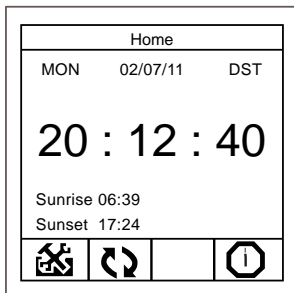

Select Setup from Home menu. 

Select Next. 

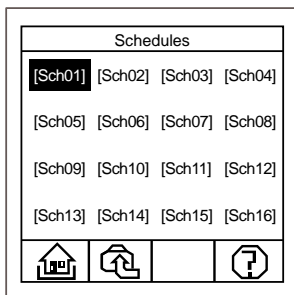
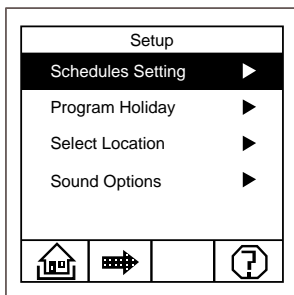

Touch Schedules Setting to display Schedule # Setup menu.

Select (Sch01). Touch again.

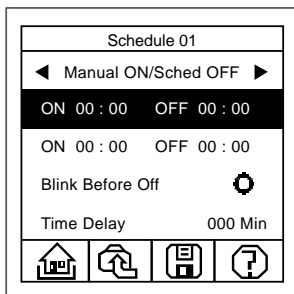
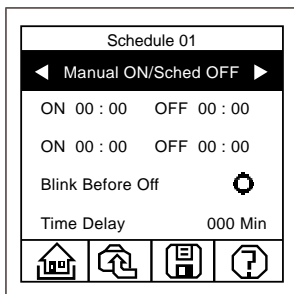

Select Manual ON/Sched OFF by touching arrows and cycling through the choices.

Touch ON/OFF to display Schedule Time menu.

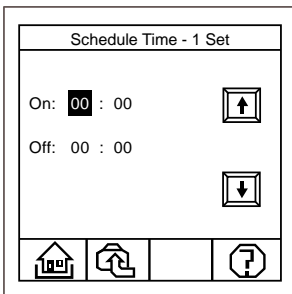

Use up and down arrows to select times.

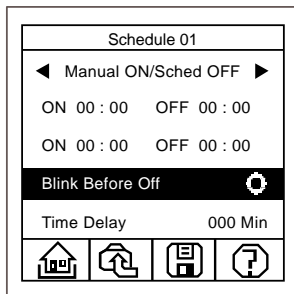

Touch the Blink Before Off display.

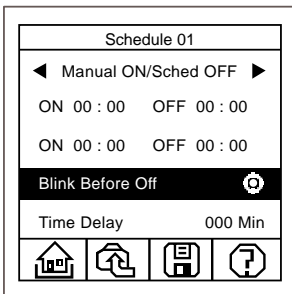

Then touch the circle display. A dot indicates the blink feature is active. No dot indicates that the blink feature is not used for this schedule.

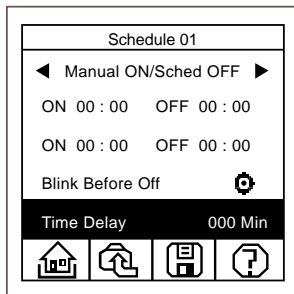

Touch time delay to display Time Delay screen.

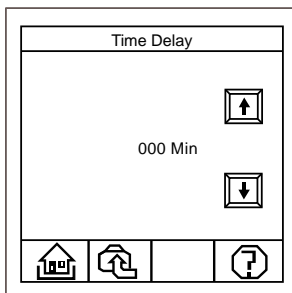

Use up and down arrows to set number of minutes between OFF sweeps.

Astronomic & Schedule ON/OFF

The astronomic feature and schedule work together by issuing commands for the lighting to turn **ON** and **OFF**. The astronomic command happens only at sunset and sunrise. The schedule command happens at the set **ON** and **OFF** times for the schedule. The lighting obeys the last command it is given.

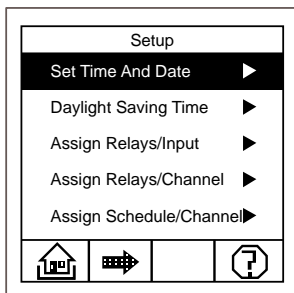
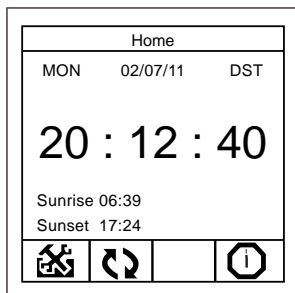

Select Setup from Home menu. 

Select Next. 

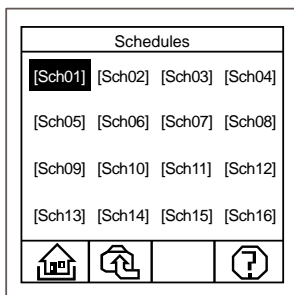
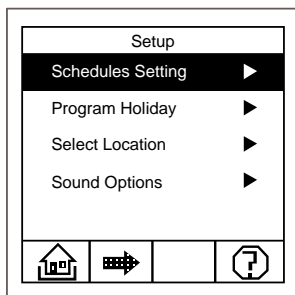

Touch Schedules Setting to display Schedule # Setup menu.

Select (Sch01).
Touch again.

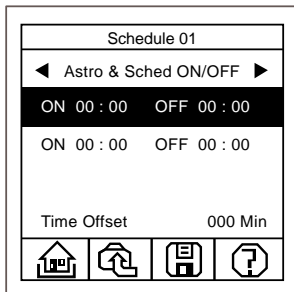
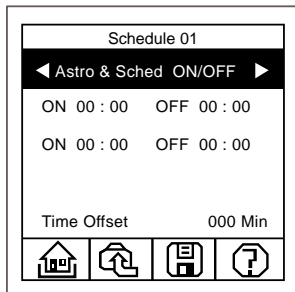

Select Astro & Sched ON/OFF by touching arrows and cycling through the choices.

Touch ON/OFF to display Schedule Time menu.

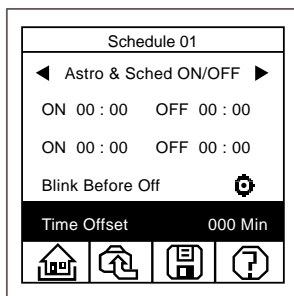

Touch Time Offset. Touch again to set sunrise or sunset offset.

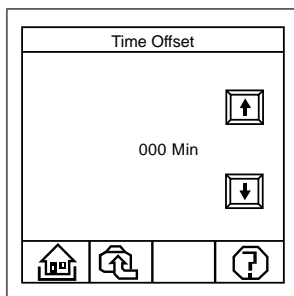

Use up and down arrows to set number of minutes for Time Offset.

Photocell & Schedule ON/OFF

The photocell and schedule act as two separate inputs each issuing commands for the lighting to turn **ON** and **OFF**. The photocell command happens only on a transition from light-to-dark or dark-to-light. The schedule command happens at the set **ON** and **OFF** times for the schedule. The lighting obeys the last command it is given. This means that if a photocell has registered there is enough light to turn the load off the load will shut off. But even in this condition, if a scheduled **ON** time is set, then the lights will turn **ON** regardless of the photocell command.

NOTE: If the photocell only is to turn the light **ON** and **OFF**, use this selection but do not enter schedule times for **ON** and **OFF**. If the Astronomic feature only is to turn the lighting **ON** and **OFF**, use this selection but do not enter schedule times for **ON** and **OFF**.

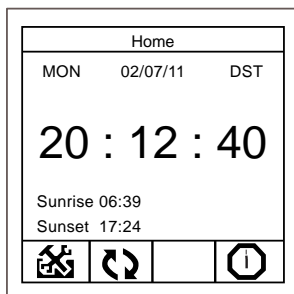

Select Setup from Home menu. 

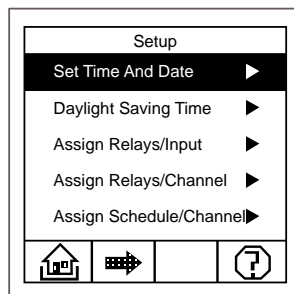

Select Next. 

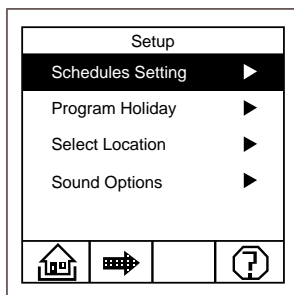

Touch Schedules Setting to display Schedule # Setup menu.

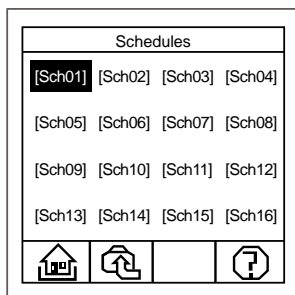

Select (Sch01). Touch again.

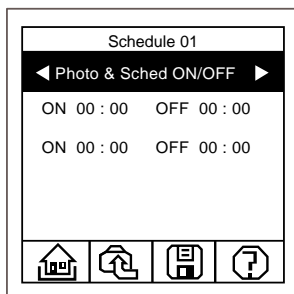

Select Photo & Sched ON/OFF by touching arrows and cycling through the choices.

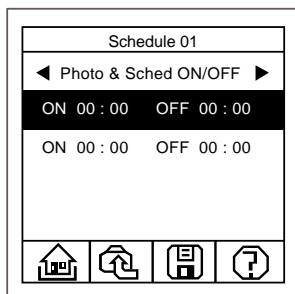

Touch ON/OFF to display Schedule Time menu.

AS-100 Auto ON/OFF

This setting will use the Auto ON/OFF feature of the AS-100 Automatic Wall Switch (see the AS-100 installation instructions for more information).

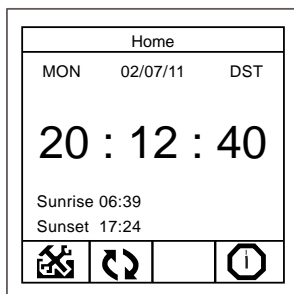

Select Setup from Home menu. 

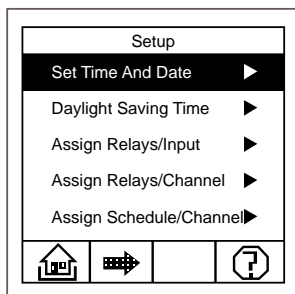

Select Next. 

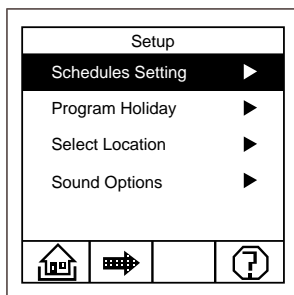

Touch Schedules Setting to display Schedule # Setup menu.

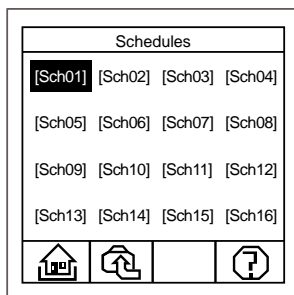

Select (Sch01). Touch again.

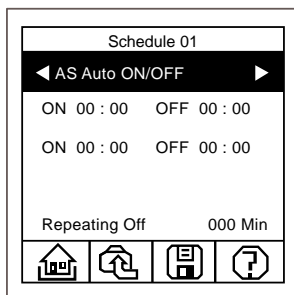

Select AS Auto ON/OFF by touching arrows and cycling through the choices.

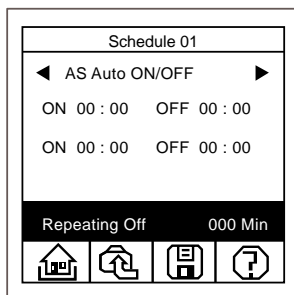

Touch Repeating Off twice to enter Time Repeat screen.

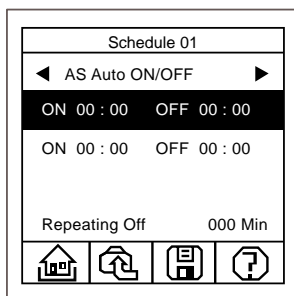

Touch ON/OFF to display Schedule Time menu.

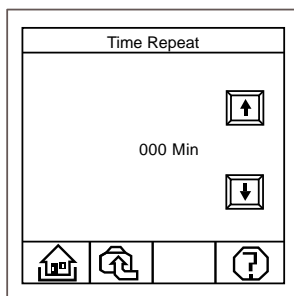

Use up and down arrows to set number of minutes between OFF sweeps during the scheduled off periods.

AS-100 Manual ON/Auto OFF

This setting will use the **Manual ON/Automatic OFF** feature of the AS-100 Automatic Wall Switch (see the AS-100 installation instructions for more information). Follow the screens for AS-100 **Auto ON/OFF**, selecting **AS Manual ON/Auto OFF** when selecting schedule type.

NOTE: The AS-100 switch must remain powered at all times in order to operate.

- Do not assign an input switch to a relay controlling the AS-100.
- Avoid assigning relay/s controlling the AS-100 to schedules other than those designed for the AS-100 (**AS Auto ON/OFF** and **AS Manual ON/Auto OFF**).
- Avoid grouping the relay controlling the AS-100 with other relays (unless relay controls another AS-100).
- When turning the relays ON/OFF from the user interface, avoid the relay/s controlling the AS-100.

Schedule Day Spanning

For a scheduled event to span midnight, it is necessary to create a schedule event in both days where the beginning of the event starts on Day 1 and ends at midnight 00:00, and another event continues on Day 2 beginning at midnight 00:00. When set up this way, the schedule event will pass through midnight without affecting the lighting. No **ON** or **OFF** event will actually occur at midnight (00:00).

Setting Up a Holiday Schedule

The schedule assigned as the Holiday Schedule is special in that it will automatically be substituted for the regular daily schedule on each of a user-entered list of calendar dates.

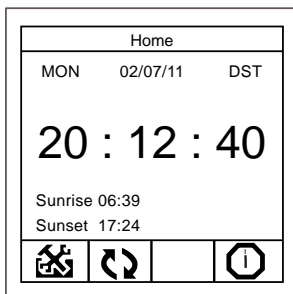

Select Setup from Home menu.

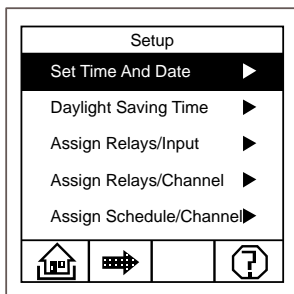

Select Next.



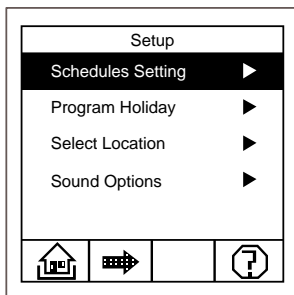

Schedules Setting displays

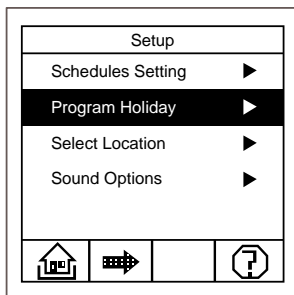

Touch Program Holiday.
Touch again.

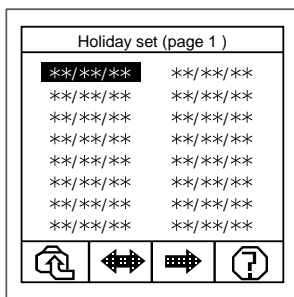

Touch a */**/** to display Holiday Date Set.

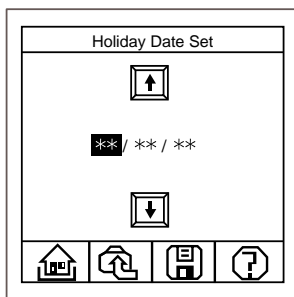

Use the up and down arrows to set month, day and year.

Select Save

To set Holiday Date Range:

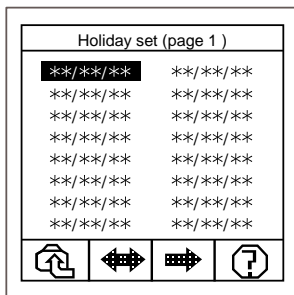

Select Range.

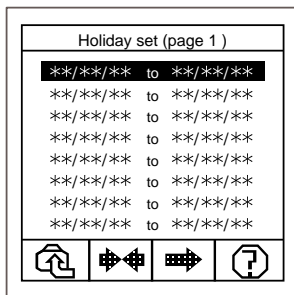

Touch a */**/** to display Holiday Date Set.

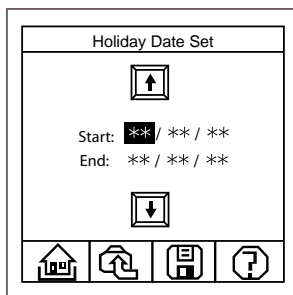

Use the up and down arrows to set Start and End Dates. .

Select Save 

Setting a Location for the Astronomic Feature

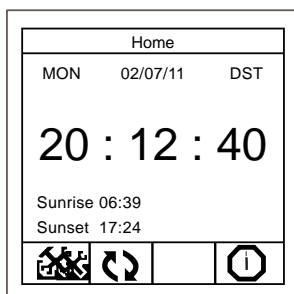

Select Setup from Home menu. 

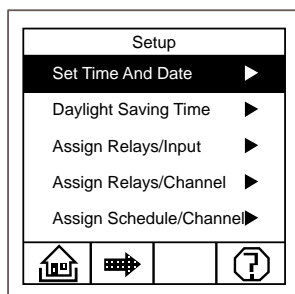

Select Next. 

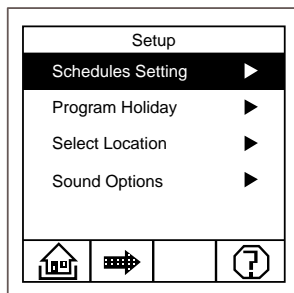

Schedules Setting displays

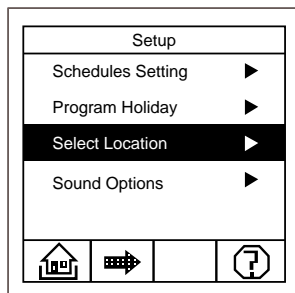

Touch Select Location.
Touch again for Location Set.

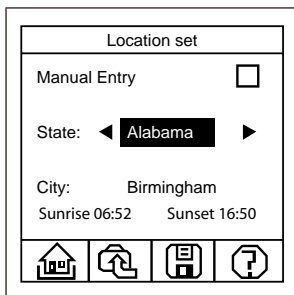

Scroll through entries to select state.
Scroll through entries to select city.

Select Save. 

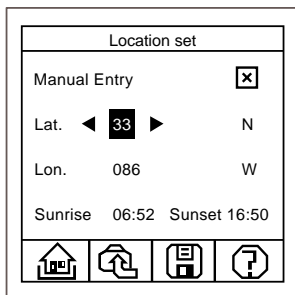

If your location is not in city/state lists, select Manual Entry. Enter Lat. and Lon.

Select Save. 

Sound Options

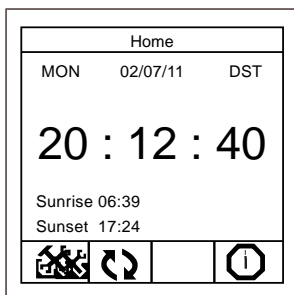

Select Setup from Home menu. 

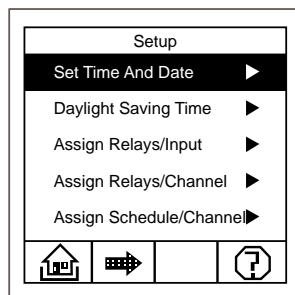

Select Next. 

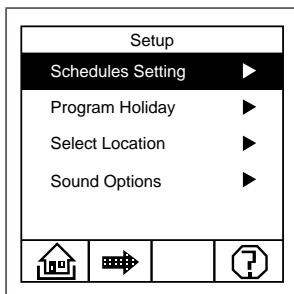

Schedules Setting displays

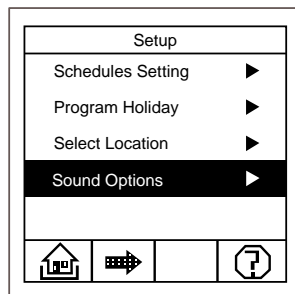

Touch Sound Options.
Touch again.

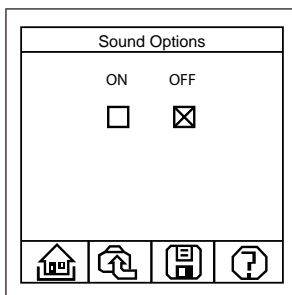

Touch the box to turn sound ON or OFF when screen is touched.

Returning the LC8 Panel to Factory Default Settings

To erase all programming and return the panel to factory default configuration:

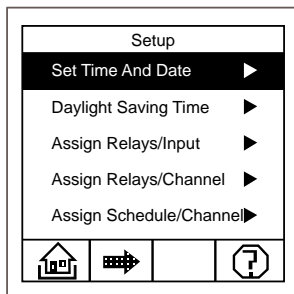
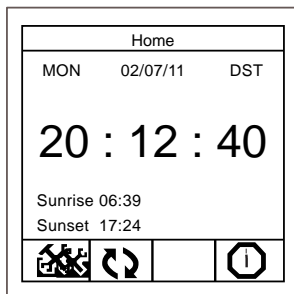

Select Setup from Home menu. 

Select Next. 

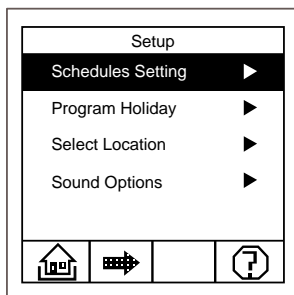

Select Next. 

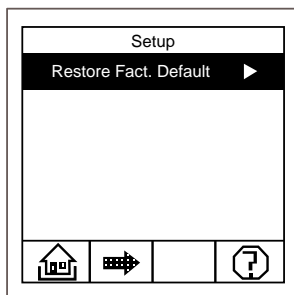

Touch Restore Fact. Default

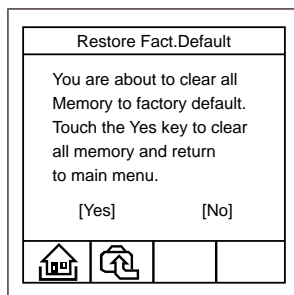

Confirm the action by touching Yes. To cancel the action and return to the menu, touch No.

TROUBLESHOOTING

Problem	What to Check	What to Do
The LCD screen is blank.	Check that the unit has power, three red LEDs illuminated on the main board.	LEDs not lit, check for input power, check circuit breaker. LEDs are lit, replace main board.
The touch screen does not control relays.	Check that the relay modules are installed per the instructions, check that the connectors between the relay module(s) are firmly seated together.	Properly install relay modules, firmly seat the connectors.
Schedule controls lights at the wrong time.	Check that the time zone is correctly set. Check that the date and time are set correctly.	Set the proper time zone. Set the proper date and time.
Photocell turns lights OFF too early.	Check the aperture setting on the photocell.	Increase the aperture size on the photocell.
Photocell turns lights OFF too late.	Check the aperture setting on the photocell.	Decrease the aperture size on the photocell.
Switch does not control the lights.	Does the corresponding touch screen INPUT override control the lights?	Check the wiring of the switch, replace switch. Check that the input# is programmed to control at least one relay.

LIGHTING CONTROL PANEL CIRCUIT & PROGRAM DOCUMENTATION FORM

Switch Input	Controlled Relays or Controlled Channel	Relay Pole	Load Description	Assigned Channel
1		1		
2		2		
3		3		
4		4		
5		5		
6		6		
7		7		
8		8		

Channel Letters below left correspond to Channel Letters above right.

Channel	Mon	Tue	Wed	Thu	Fri	Sat	Sun
A							
B							
C							
D							
E							
F							
G							
H							

Enter the schedule numbers that apply in the spaces above.

WARRANTY INFORMATION

Wattstopper warrants its products to be free of defects in materials and workmanship for a period of five (5) years. There are no obligations or liabilities on the part of Wattstopper for consequential damages arising out of, or in connection with, the use or performance of this product or other indirect damages with respect to loss of property, revenue or profit, or cost of removal, installation or reinstallation.

