

Double & Single ended By Pass/Line Voltage

1. Product Features:

- UL certified

- Single ended:

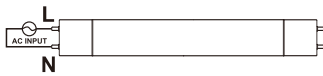

- Full glass housing: No Aging, Yellowing, Bending.

- Double ended:

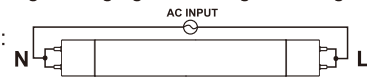

2. Product Applications:

Widely used in residential buildings, offices, shopping malls, supermarkets, hospitals, assembly lines, warehouses, etc. for energy saving illumination.

3. Installation Instructions:

Please completely comply with these instructions and notes, to ensure that the product is operated in a safe condition.

⚠ Safety Precautions:

For your and others' safety, please read the precaution carefully before installation:

- (1). Product should be installed by qualified electrician.
- (2). Switch off the power supply before commencing work, make sure correct connection before power on.
- (3). Suitable for use with the following emergency equipment : PRECISION LIGHTING & TRANSFORMER, INC., model PLTSP91, PLTSP92.

⚠ WARNING:

WARNING - Risk of fire or electric shock. LED Retrofit Kit installation requires knowledge of luminaires electrical systems. If not qualified, do not attempt installation. Contact a qualified electrician.

AVERTISSEMENT - Risque d'incendie ou de choc électrique. Installation du kit de Retrofit LED exige une connaissance des systèmes électriques luminaires. Si vous n'êtes pas qualifié, ne tentez pas de l'installation. Contactez un électricien qualifié.

WARNING - Risk of fire or electric shock. Install this kit only in the luminaires that have the construction features and dimensions shown in the photographs and/or drawings and where the input rating of the retrofit kit does not exceed the input rating of the luminaire.

AVERTISSEMENT - Risque d'incendie ou de choc électrique. Installez ce kit dans les luminaires qui ont les caractéristiques de construction et les dimensions indiquées dans les photographies et / ou dessins et où la cote d'entrée du kit de modification ne dépasse pas la capacité d'entrée du luminaire.

WARNING -To prevent wiring damage or abrasion, do not expose wiring to edges of sheet metal or other sharp objects.

AVERTISSEMENT - Pour éviter d'endommager le câblage ou à l'abrasion, ne pas exposer le câblage aux bords de tôle ou d'autres objets pointus.

WARNING: To avoid potential fire or shock hazard, do not use this retrofit kit in luminaires employing shunted bi-pin lampholders. Note: Shunted lamp holders are found only in fluorescent luminaires with Instant-Start ballasts. Instant-start ballasts can be identified by the words "Instant Start" or "I.S." marked on the ballast. This designation may be in the form of a statement pertaining to the ballast itself, or may be combined with the marking for the lamps with which the ballast is intended to be used, for example F40T12/IS. For more information, contact the LED luminaire retrofit kit manufacturer.

AVERTISSEMENT: Pour éviter tout incendie potentiel ou tout risque de choc, ne pas utiliser ce kit de rénovation dans les luminaires utilisant des douilles shuntées à deux broches. Remarque: les supports de lampe shunté ne se trouvent que sur les luminaires fluorescents avec ballasts et à allumage instantané. Les ballastes à allumage instantané peuvent être identifiés par les mots "Démarrage instantané" ou "I.S" sur la ballaste. Cette désignation peut être présentée sous la forme d'une déclaration relatives au ballast lui-même, ou peut être combinée avec le marquage pour les lampes dont le ballast est destiné à être utilisé, par exemple le modèle F40T12 / EST. Pour plus d'informations, contactez le fabricant du kit de rénovation de luminaire LED.

Do not make or alter any open holes in an enclosure of wiring or electrical components during kit installation.

Installers should not disconnect existing wires from lamp holder terminals to make new connections at lamp holder terminals. Instead installers should cut existing lamp holder leads away from the lamp holder and make new electrical connections to lamp holder lead wires by employing applicable connectors.

THIS RETROFIT ASSEMBLY IS ACCEPTED AS A COMPONENT OF A LUMINAIRE WHERE THE SUITABILITY OF THE COMBINATION SHALL BE DETERMINED BY UL OR AUTHORITIES HAVING JURISDICTION. THERE ARE TUBE, OPERATION INSTRUCTION AND THE FIELD APPLIED DOUBLE-ENDED OR SINGLE-ENDED APPLICATION LABEL IN THIS RETROFIT KIT.

Type B LAMP – intended for operation in luminaires with traditional fluorescent-type lamp holders wired directly to the branch circuit. This includes both factory-wired luminaires as well as those converted for this purpose under a retrofit program.



Any further questions or interests, please visit

www.pltsolutions.com

The units covered by this report were intended to retrofit surface mount, Type IC or non-IC recessed mount Listed fluorescent luminaires that use maximum 4 tubular lamps, the minimum lamp compartment dimensions are tabulated below:

Model Number	MINIMUM LAMP COMPARTMENT DIMENSIONS [Length x Width x Height] [mm]	Lamp Quantity	Lamp-to-lamp Spacing [cm]
PLTSP3F213/PLTSP3F214 PLTSP3F215/PLTSP3E213 PLTSP3E214/PLTSP3E215	1230 x 340 x 45	4	3

This device complies with Part 15 of the FCC Rules. Operation is subject to the following two conditions:
(1) this device may not cause harmful interference,
and (2) this device must accept any interference received, including interference that may cause undesired operation.

⚠ The below ballast wiring represents typical configuration. The actual ballast wiring varies according to ballast model. The socket should be non-shunted.

Single ended Wiring Instruction

Retrofit luminaire with 1 lamp

Instant Start

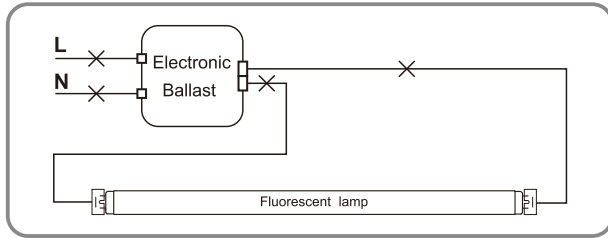

Program Start or Rapid Start

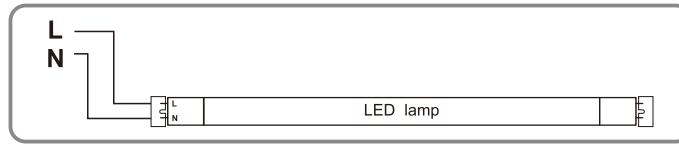
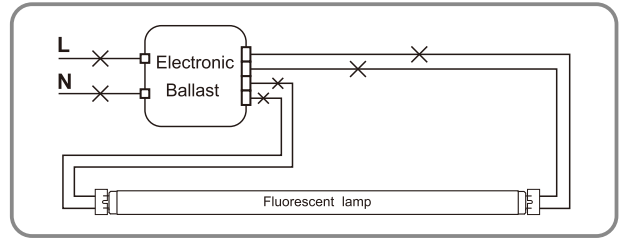

Retrofit luminaire with 2 lamps

Instant start

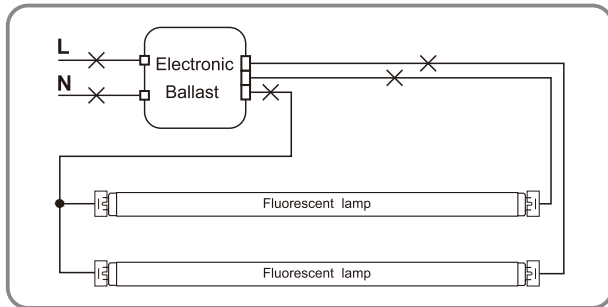

Program Start or Rapid Start

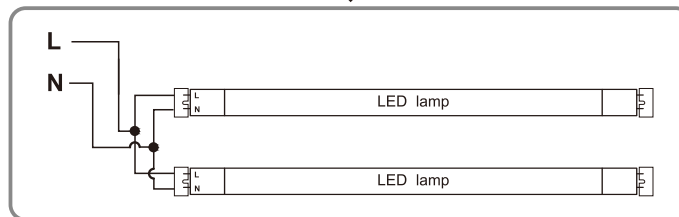
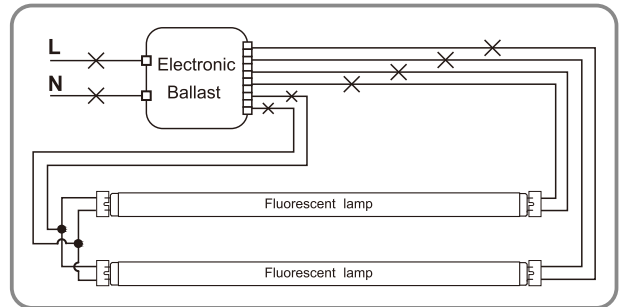

Any further questions or interests, please visit

www.pltsolutions.com

Retrofit luminaire with 3 lamps

Instant start

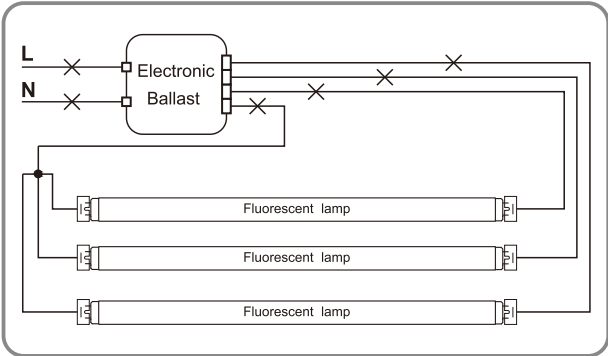

Program Start or Rapid Start

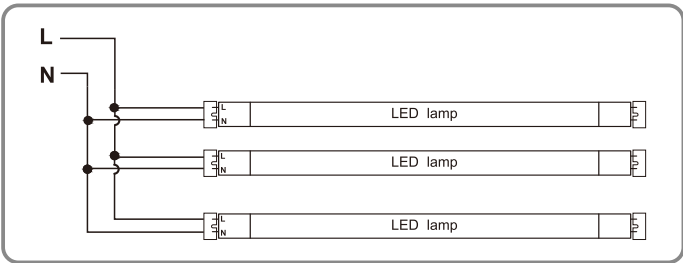
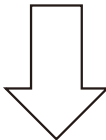
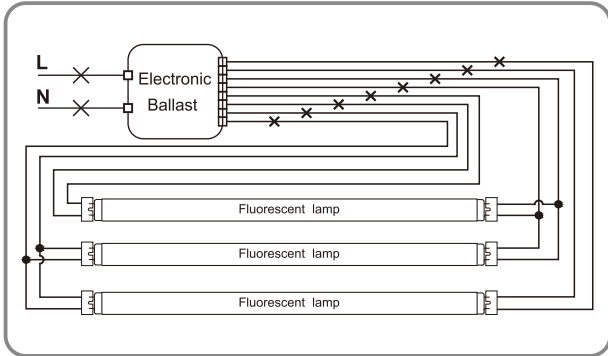

Retrofit luminaire with 4 lamps

Instant start

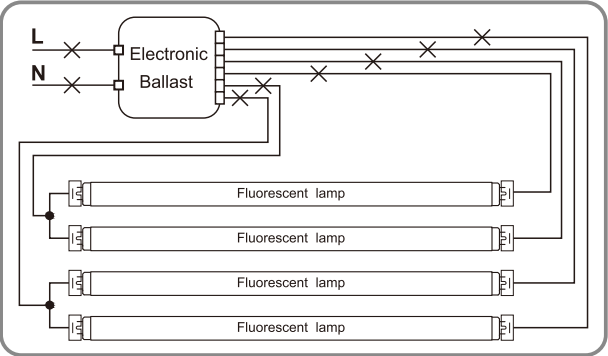

Program Start or Rapid Start

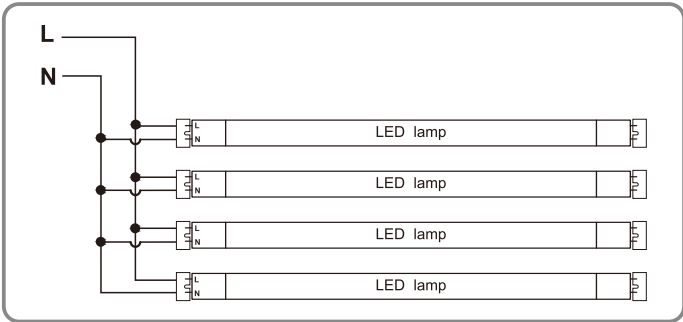
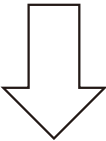
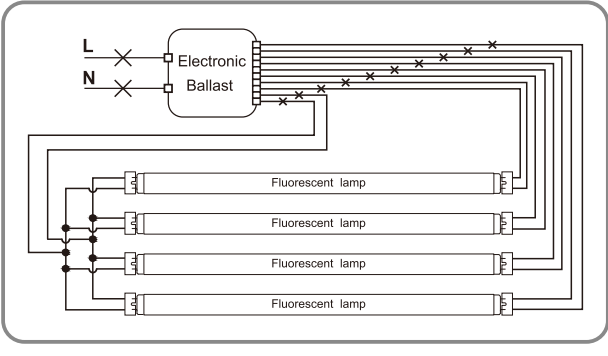

Any further questions or interests, please visit

www.pltsolutions.com

⚠ The below ballast wiring represents typical configuration. The actual ballast wiring varies according to ballast model. It is not needed to change socket (if in good condition) to operate double ended lamps, regardless the type of sockets. Please make sure one side of fixture is connected to Live (L) and the other side to Neutral (N).

Double ended Wiring Instruction

Retrofit luminaire with 1 lamp

Instant Start

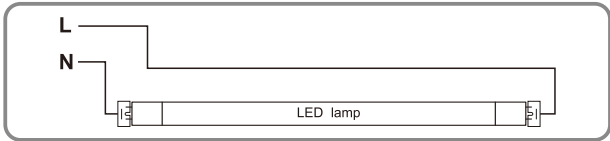
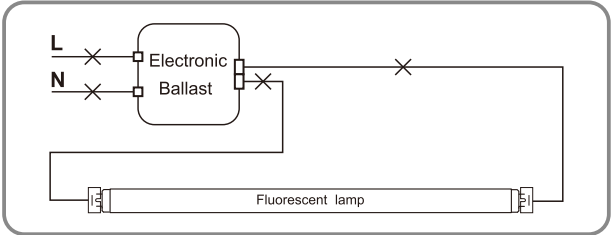

Program Start or Rapid Start

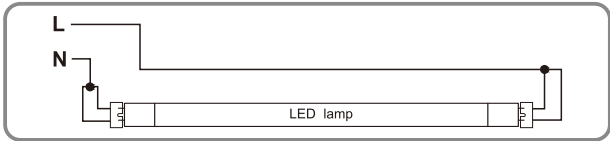
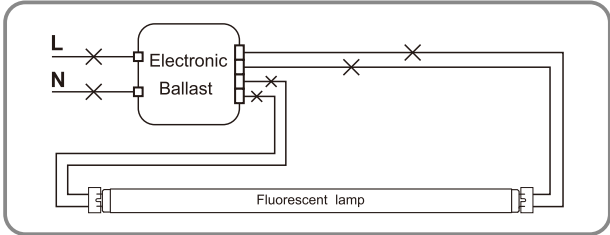

Retrofit luminaire with 2 lamps

Instant Start

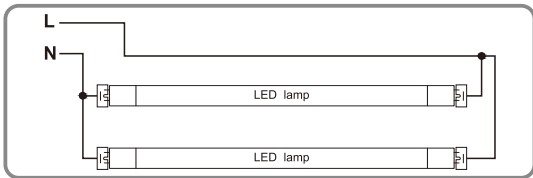
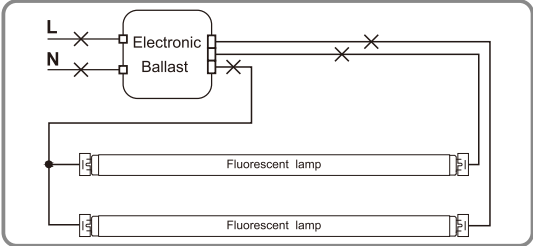

Program Start or Rapid Start

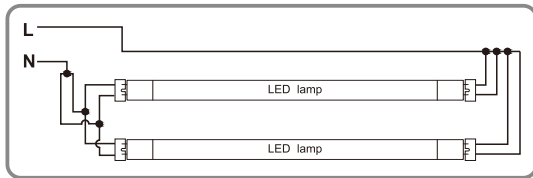
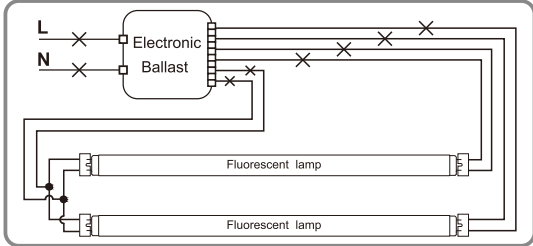

Any further questions or interests, please visit

www.pltsolutions.com

Retrofit luminaire with 3 lamps

Instant Start

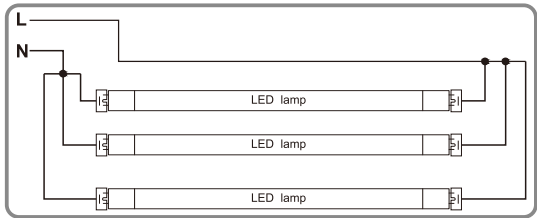
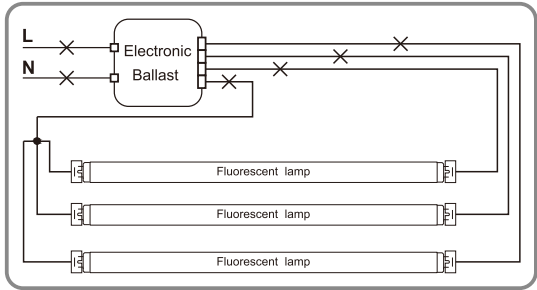

Program Start or Rapid Start

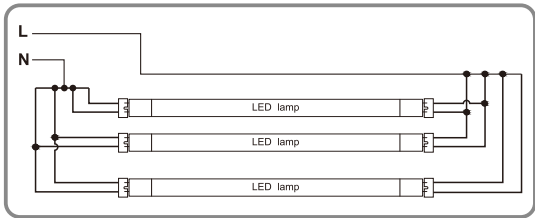
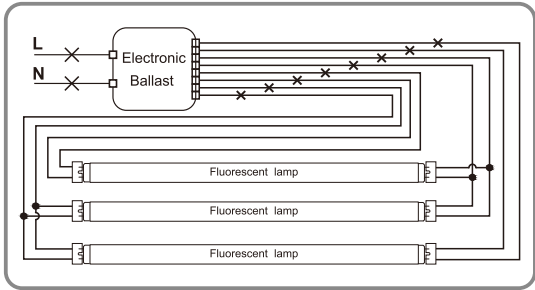

Retrofit luminaire with 4 lamps

Instant Start

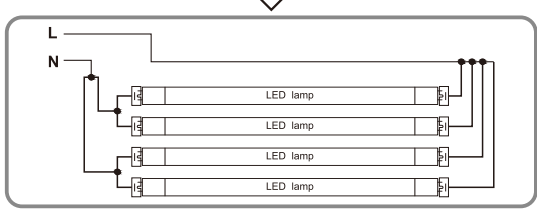
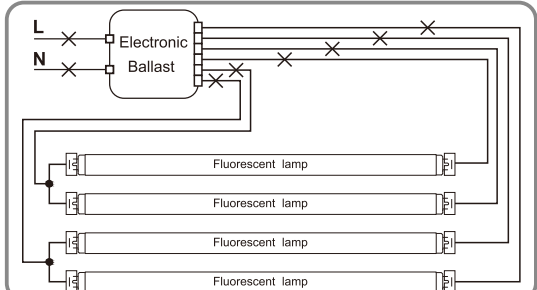

Program Start or Rapid Start

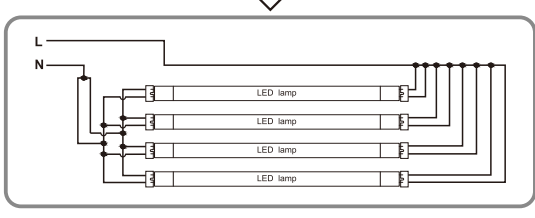
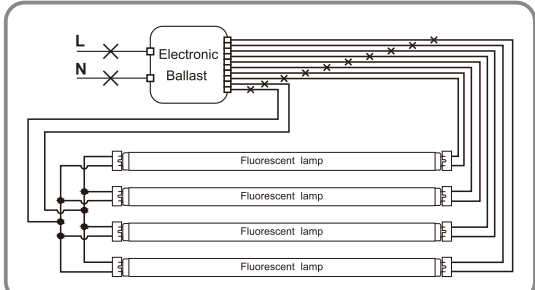

Any further questions or interests, please visit

www.pltsolutions.com