

DESCRIPTION

Featuring a low-profile design, this 240W round LED high bay is a cost-effective solid state solution for high bay applications, providing a one-for-one replacement of 1000 Watt metal halide fixtures.

FEATURES

- Up to 134 LPW ultra-high efficiency delivers superior performance over older HID high bays
- 0-10V dimming
- Instant-on with no warmup
- 6kV surge protection
- 6' power cord w/o plug standard for more installation flexibility
- Provides direct and indirect lighting, meaning that it directly lights the floor below and indirectly lights the ceiling above

LISTINGS

- IP65 Rated
- UL Listed for wet locations
- DesignLights Consortium® 5.1 Standard - meets the requirements for the highest DLC qualification for efficacy and lumen maintenance; DLC PN - PLTSN131422RP

PERFORMANCE

- CRI: >80
- CCT: 5000K
- Rated lifetime L70: 50000 hours
- Philips Lumileds LEDs and Sosen driver

THERMAL

- -40°F to 122°F (-40°C to 50°C) operating temperature

ELECTRICAL

- THD: ≥ 0.9
- Power Factor: ≤ 20%
- Input Voltage: 120-277V
- Surge Protection: 6kV
- Dimmable power supply (0-10V)

INSTALLATION

- Suspended mounting with included 10mm ring or surface mounting with u-bracket (sold separately); see installation instructions for more information

CONSTRUCTION

- Ships standard with impact resistant polycarbonate lens & reflector (90°)
- Slim, lightweight die-cast aluminum construction (9.57 lbs) allows for quick and easy installation
- 18-gauge power conductors (Line, Neutral, and Ground)
- 22-gauge control conductors (DIM +, DIM -, AUX)

project name	type
catalog number	
comments	voltage
approved by	date



WARRANTY

- 5 year limited warranty; see pltsolutions.com for warranty details

APPLICATIONS

- Warehouses
- Manufacturing Plants
- Distribution Centers
- Grocery Stores
- Gymnasiums
- Indoor Recreational Facilities
- Cold Storage
- Big Box Retail
- Service Repair Centers

PERFORMANCE SUMMARY

Item #	Model	Watts	Lumens	LPW	CCT	CRI	Dimming	Voltage	Replaces	DLC #	DLC Rating
PLTS-11995	Round High Bay w/ Reflector	240	32,078	134	5000K	>80	0-10V	120-277V	MH1000	PLTSN131422RP	DLC Standard 5.1

MOUNTING ACCESSORIES

SKU	Description
PLTS-12282	Adjustable U-Bracket - Black

DIMENSIONS

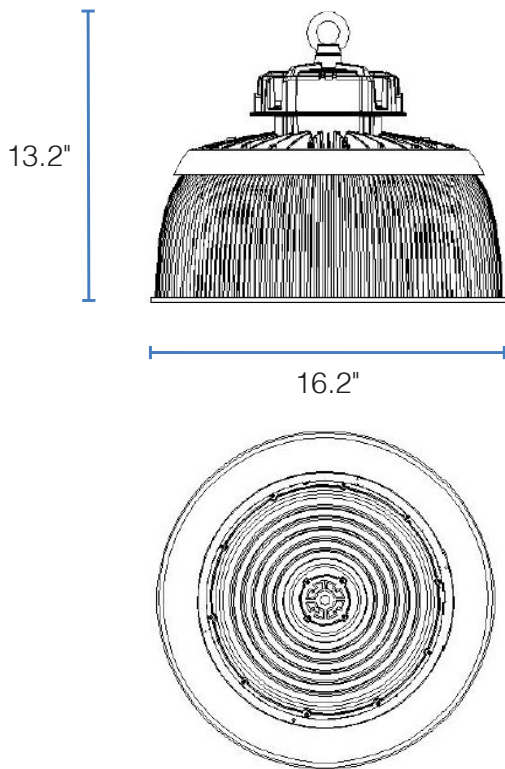

DIMENSIONS

Height: 7.3"
Diameter: 14.2"
Weight: 7.94 lbs.

DIMENSIONS W/ REFLECTOR

Height: 13.2"
Diameter: 16.2"
Weight: 9.57 lbs.

Ring Mount Thread Size: 10MM