

DESCRIPTION

A long-lasting and highly efficient replacement for metal halide fixtures, use this LED canopy light to improve outdoor security lighting.

FEATURES

- Delivers an impressive 130 LPW
- Replaces 250W metal halide fixtures
- 0-10V dimming
- Instant on with no warmup
- Built in 4kV surge protection

LISTINGS

- IP65 Rated
- UL Listed for wet locations
- FCC Part 15, Part B, Class A
- DesignLights Consortium® 5.1 Premium - meets the requirements for the highest DLC qualification for efficacy and lumen maintenance; DLC PN - PLTBE35[S;blank]

PERFORMANCE

- CRI: >70
- CCT: 5000K
- LED L70 Life Hours: ≥100,000 hours
- Philips Lumileds LEDs

ELECTRICAL

- THD: <20%
- Power Factor: >0.95
- Surge Protection: 4kV
- Input Voltage: 120-277V

THERMAL

- -40°F to 122°F (-40°C to 50°C) operating temperature

INSTALLATION

- Designed for pendant or surface mounting with J-box (not included); see installation instructions for more information

CONSTRUCTION

- Low-profile aluminum housing with bronze powder coat finish
- Polycarbonate lens

project name	type
catalog number	
comments	voltage
approved by	date



WARRANTY

- 5 year limited warranty; see pltsolutions.com for warranty details

APPLICATIONS

- Warehouses
- Factories
- Hospitals
- Hotels
- Offices

PERFORMANCE SUMMARY

Item #	Watts	Lumens	LPW	CRI	CCT	Lens	Dimming	Voltage	Replaces	DLC #	DLC Level
PLT-11930	75	9700	130	>70	5000K	Polycarbonate	0-10V	120-277	MH250	PLTBE35[S;blank]	5.1 Premium

DIMENSIONS

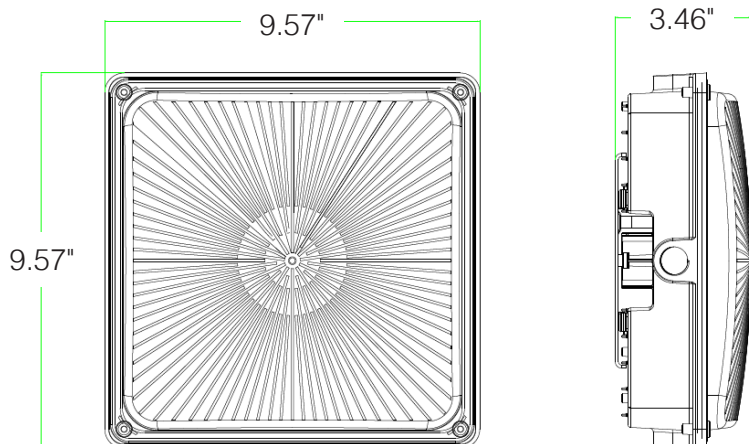

DIMENSIONS

Length: 9.57"
 Height: 3.46"
 Width: 9.57"
 Weight: 4.6 lbs.

PHOTOMETRICS

