

LED Luminaires

ProLED Select Volumetric Panel Series

- Selectable Wattage
- Selectable Color Temperatures
- 0-10V Dimming
- Direct Backlit Design
- 5 Year Warranty



Specifications



Description

The ProLED Select Volumetric Panel Series provides an architectural, modern design with increased visual comfort and functionality. This innovative product features both Wattage and CCT Selectability to make this one of the most versatile Volumetric Panels on the market.

Construction

- Wattage Select Dipswitch - Protective Shield
- CCT Select Dipswitch
- Die-Cast Steel Housing
- Diffused Polycarbonate Lens
- Multiple Knockouts on Driver Compartment

Certifications

- DLC Premium
- cULus
- ROHS Compliant
- IC Rated
- Damp Location

Performance

- Selectable Wattage between 15W-49W
- Selectable Color Temperatures between 3500K - 5000K
- >140LPW
- L70 Lumen Maintenance > 50,000 Hours
- 5 Year limited Warranty
- 0-10V Dimming
- 120-277V

ProLED Select Volumetric Panel Series

Product Description

Ordering Logic

Product Size	Series	CRI	Dimmable	Voltage	Options
14 = 1x4 22 = 2x2 24 = 2x4	FSVPL = Field Selectable Volumetric Panel	8 = 80	D = Dimmable (0-10V)	U = 120/277V	Blank = NA EM = Emergency Battery

Ordering Information

Product SKU	Product Code	Product Description
81779	14FSVPL/8DU	ProLED Select Volumetric Panel 1x4 Selectable Wattage and CCT 0-10V Dimmable
81780	22FSVPL/8DU	ProLED Select Volumetric Panel 2x2 Selectable Wattage and CCT 0-10V Dimmable
81781	24FSVPL/8DU	ProLED Select Volumetric Panel 2x4 Selectable Wattage and CCT 0-10V Dimmable

Accessories

Product SKU	Product Code	Product Description
81782	14VPL/SMK	1X4 Surface Mount Kit for Volumetric Panels
81783	22VPL/SMK	2x2 Surface Mount Kit for Volumetric Panels
81784	24VPL/SMK	2X4 Surface Mount Kit for Volumetric Panels
10310	BBU/EM8WU	Emergency Battery Back Up 8W 120-277V*

* Not compatible with 1x4 housing (81779)*

Dimensions

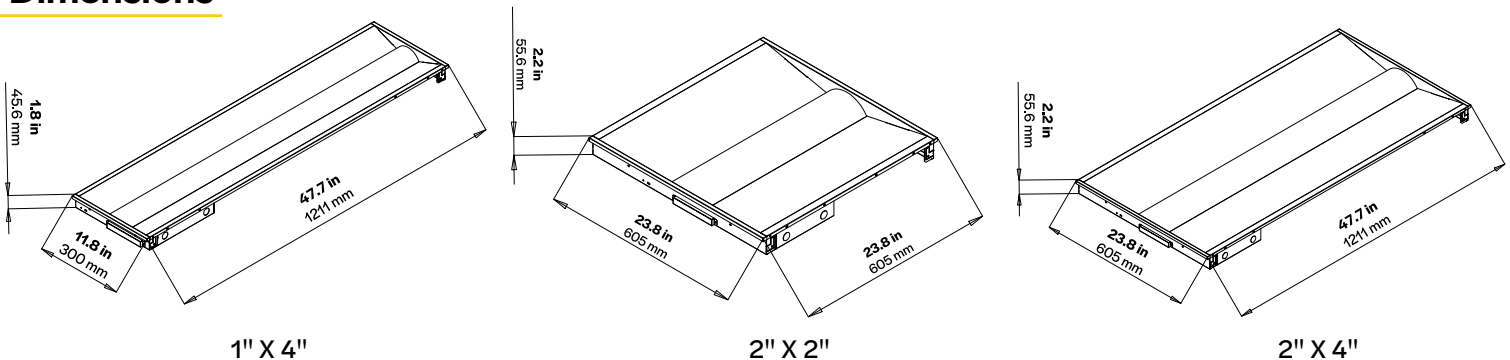

ProLED Select Volumetric Panel Series

Specifications Table

	1x4	2x2	2x4
Nominal Wattage	Selectable - 15W/19W/24W/29W	Selectable - 15W/19W/24W/29W	Selectable - 24W/29W/32W/39W
Delivered Lumens	2190lm - 4437lm	2175lm - 4379lm	3384lm - 5889lm
CCT	Selectable - 3500K, 4000K, 5000K	Selectable - 3500K, 4000K, 5000K	Selectable - 3500K, 4000K, 5000K
Efficacy (lm/W)	141LPW - 158LPW	141LPW - 156LPW	136LPW - 157LPW
CRI	>80		
L70 Lifetime (hrs)	50,000		
Voltage	120-277V		
Power Factor	>0.9		
Dimming	0-10V		
Housing	Die Cast Steel		
Lens	Diffused Lens		
Operating Temperature	-20°C - 40°C		
Listings	DLC Premium, cULus, FCC		
Environment	UL Damp Location, IC Rated		
Weight (lbs)	9.03lb	7.16lb	14.33lb
Warranty	5 Years Standard		

Performance Table

Product Code	Selectable Wattage	3500K		4000K		5000K	
		Lumen Output (lm)	Efficacy (lm/W)	Lumen Output (lm)	Efficacy (lm/W)	Lumen Output (lm)	Efficacy (lm/W)
14FSVPL/8DU	15	2190	146	3002	158	2220	148
	19	2736	144	2964	156	2774	146
	24	3408	142	3696	154	3456	144
	29	4094	141	4437	153	4147	143
22FSVPL/8DU	15	2175	145	2340	156	2205	147
	19	2717	143	2926	154	2755	145
	24	3384	141	3648	152	3432	143
	29	4077	141	4379	151	4118	142
24FSVPL/8DU	24	3384	141	3768	157	3504	146
	29	4031	139	4495	155	4176	144
	32	4384	137	4896	153	4544	142
	39	5300	136	5889	151	5499	141

ProLED® Select Volumetric Panel Series

Dimensions

ZONAL LUMEN SUMMARY

Zone	Lumens	%Lamp	%Fixt
0-20	501.55	12.20	12.20
0-30	1064.76	26.00	26.00
0-40	1745.14	42.00	42.00
0-60	3119.91	76.20	76.20
0-80	4001.46	97.70	97.70
0-90	4091.43	99.90	99.90
10-90	3961.64	96.70	96.70
20-40	1243.59	30.40	30.40
20-50	1955.87	47.80	47.80
40-70	1914.03	46.70	46.70
60-80	881.55	21.50	21.50
70-80	342.30	8.40	8.40
80-90	89.97	2.20	2.20
90-110	0.00	0.00	0.00
90-120	0.00	0.00	0.00
90-130	0.00	0.00	0.00
90-150	1.39	0.00	0.00
90-180	3.87	0.10	0.10
110-180	3.87	0.10	0.10
0-180	4095.31	100.00	100.00

Total Luminaire Efficiency = 100.00%

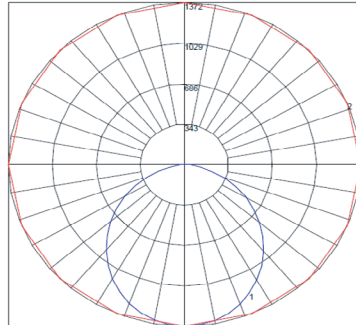

Maximum Candela = 1371.8 Located At Horizontal Angle = 0, Vertical Angle = 0
 # 1 - Vertical Plane Through Horizontal Angles (0 - 180) (Through Max. Cd.)
 # 2 - Horizontal Cone Through Vertical Angle (0) (Through Max. Cd.)

ProLED Select Volumetric Panel - 1x4

Settings: 29W at 3500K

ZONAL LUMEN SUMMARY

Zone	Lumens	%Lamp	%Fixt
0-20	490.48	12.00	12.00
0-30	1041.17	25.50	25.50
0-40	1706.18	41.80	41.80
0-60	3046.73	74.70	74.70
0-80	3950.16	96.80	96.80
0-90	4076.6	99.90	99.90
10-90	3949.62	96.80	96.80
20-40	1215.7	29.80	29.80
20-50	1910.83	46.80	46.80
40-70	1872.91	45.90	45.90
60-80	903.43	22.10	22.10
70-80	371.07	9.10	9.10
80-90	126.43	3.10	3.10
90-110	0.00	0.00	0.00
90-120	0.00	0.00	0.00
90-130	0.00	0.00	0.00
90-150	0.57	0.00	0.00
90-180	2.42	0.10	0.10
110-180	2.42	0.10	0.10
0-180	4079.02	100.00	100.00

Total Luminaire Efficiency = 100.00%

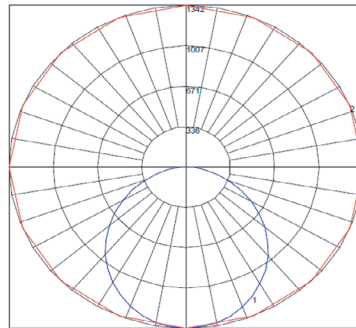

Maximum Candela = 1342.4 Located At Horizontal Angle = 0, Vertical Angle = 0
 # 1 - Vertical Plane Through Horizontal Angles (0 - 180) (Through Max. Cd.)
 # 2 - Horizontal Cone Through Vertical Angle (0) (Through Max. Cd.)

ProLED Select Volumetric Panel - 1x4

Settings: 29W at 3500K

ZONAL LUMEN SUMMARY

Zone	Lumens	%Lamp	%Fixt
0-20	639.36	12.10	12.10
0-30	1357.88	25.60	25.60
0-40	2225.77	42.00	42.00
0-60	3970.04	74.90	74.90
0-80	5134.65	96.80	96.80
0-90	5300.03	100.00	100.00
10-90	5134.61	96.80	96.80
20-40	1586.41	29.90	29.90
20-50	2492.28	47.00	47.00
40-70	2432.1	45.90	45.90
60-80	1164.61	22.00	22.00
70-80	476.78	9.00	9.00
80-90	165.38	3.10	3.10
90-110	0.00	0.00	0.00
90-120	0.00	0.00	0.00
90-130	0.00	0.00	0.00
90-150	0.80	0.00	0.00
90-180	2.57	0.00	0.00
110-180	2.57	0.00	0.00
0-180	5302.6	100.00	100.00

Total Luminaire Efficiency = 100.00%

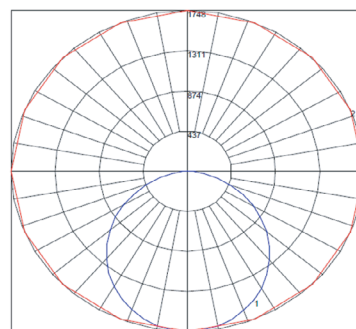

Maximum Candela = 1746.4 Located At Horizontal Angle = 0, Vertical Angle = 0
 # 1 - Vertical Plane Through Horizontal Angles (0 - 180) (Through Max. Cd.)
 # 2 - Horizontal Cone Through Vertical Angle (0) (Through Max. Cd.)

ProLED Select Volumetric Panel - 1x4

Settings: 39W at 3500K