

DESCRIPTION

A cost-effective, low-profile, solid state solution for high bay applications, providing one-for-one replacement of 250 Watt metal halide fixtures.

FEATURES

- 0-10V dimming
- Instant-on with no warmup
- 6' power cord standard for more installation flexibility
- Up to 150 LPW ultra-high efficiency delivers superior performance over legacy HID high bays

LISTINGS

- UL Listed for wet locations
- IP66 Rated for dust and high pressure water ingress protection
- DesignLights Consortium®5.1 Premium - meets the requirements for the highest DLC qualification for efficacy and lumen maintenance; DLC Part Number - PLTE71131

PERFORMANCE

- CRI: 80+
- Rated lifetime L70: 120,000hours
- Philips Lumileds LEDs and Sosen driver

THERMAL

- -22°F to 122°F (-30°C to +50°C) operating temperature

ELECTRICAL

- THD: <20%
- Power Factor: >.9
- Input voltage: 120-277V
- Dimmable power supply (0-10V)

CONSTRUCTION

- Ships standard with impact resistant polycarbonate lens & reflector (90°)
- Slim, lightweight construction (7.5 lbs) allows for quick and easy installation

WARRANTY

- 5 year limited warranty; see pltsolutions.com for warranty details

project name	type
catalog number	
comments	voltage
approved by	date



APPLICATIONS

- Warehouses
- Manufacturing Plants
- Distribution Centers
- Grocery Stores
- Gymnasiums
- Indoor Recreational Facilities
- Cold Storage
- Big Box Retail
- Service Repair Centers

PERFORMANCE SUMMARY

Item #	Model	Watts	Lumens	LPW	CCT	CRI	Dimming	Voltage	Replaces	DLC #	DLC Rating
PLT-80002	Aurora	100	15000	150	5000K	80+	0-10V	120-277	MH250	PLTE71131	DLC Premium 5.1

DIMENSIONS

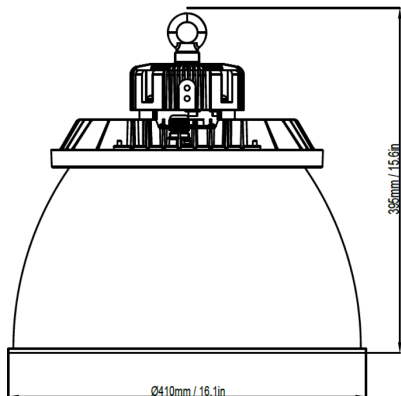

DIMENSIONS

Diameter: 12.2"

Height: 6.7"

Weight: 7.5 lbs.

W/ REFLECTOR

Diameter: 18.9"

Height: 14.4"

Weight: 13.3 lbs.

PHOTOMETRICS

90° RIBBED LENS

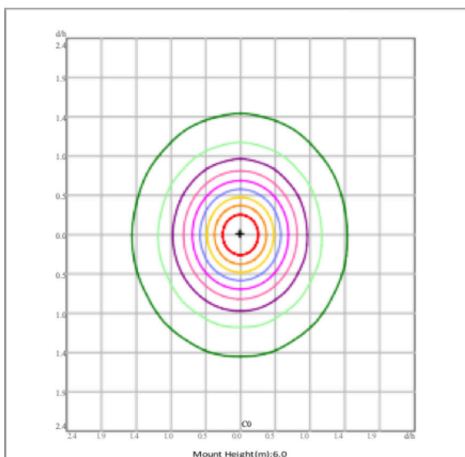
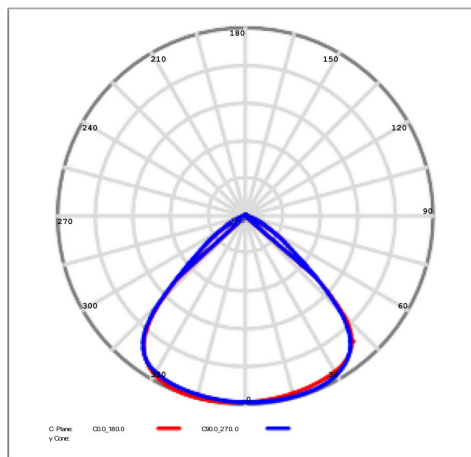

90° REFLECTOR

