



FHUPS1-UNV-25L-SD



IP20



25W Sinusoidal Emergency Micro Inverter

- Emergency Micro Inverter with sine wave output
- Universal AC Input Voltage: 100-277VAC
- Auto Select Output Voltage: 120/220/277VAC
- Driver Type: Limit Max Power
- Output Power: 25W Max. (45VA Max.)
- Long Case and Conduit
- IP20

General Specifications

Input Voltage / Frequency	100-277VAC , 50/60Hz
Input Current	0.12A
Input Power	11W
AC LED Drive Input Power	150W Max.
Standby Input Power	Meet CEC
Driver Type	Limit Max Power
Output Power	25W Max.(45VA Max.)
Output Voltage Range	120/220/277VAC,60Hz.
Load Power Factor Range	25W Load PF >0.55
Number of Output Channels	1 Channel
RFI/EMI	FCC Part 15A Non-Consumer
Output Type	Non-Isolated
Battery Type	LiFePO4
Battery Capacity Available	3600mAh
Battery Recharge Time	12Hours
Battery Discharge Time	90 Minutes Min.
Test Switch Remote Mounting Distance	65.6' (20m) Max.
Input Surge Protection	Line-Neutral 2kV, Line & Neutral-Ground 3kV
Protections	Under Voltage Protection Overload Protection Short Circuit Protection
Rated Ambient(ta)	0°C To 50°C (32°F To 122°F)
Sound Rating	A
Service Life	50,000 hours
Warranty	5 years
Approvals/Class	UL924, CSA C22.2 NO.141-10/cUL CEC, MSDS, DGM RoHS, IP20

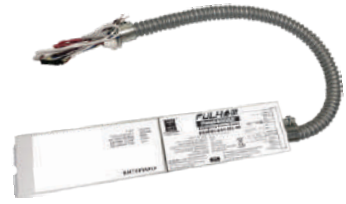

FHUPS1-UNV-25L-SD



Mechanical Diagram

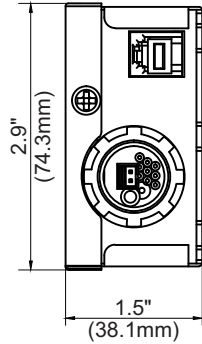

Overall Dimensions	
Length	15.3" (388.2mm)
Width	2.9" (74.3mm)
Height	1.5" (38.1mm)

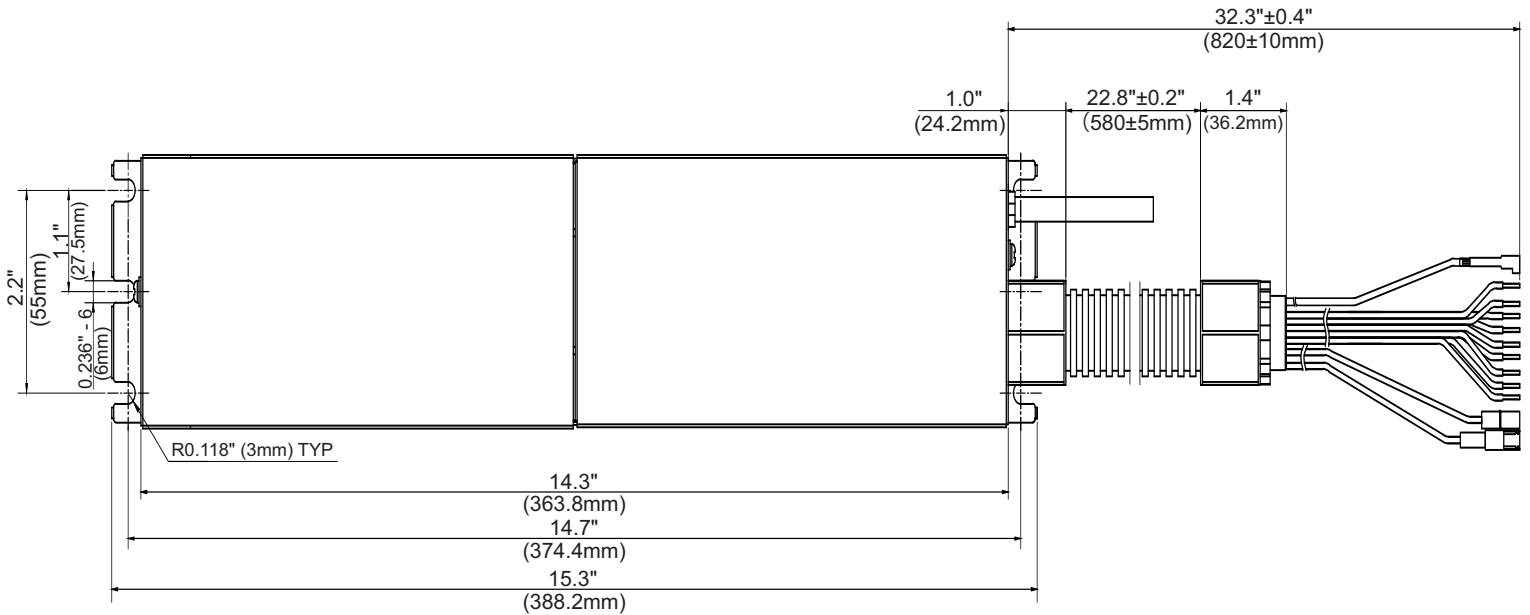
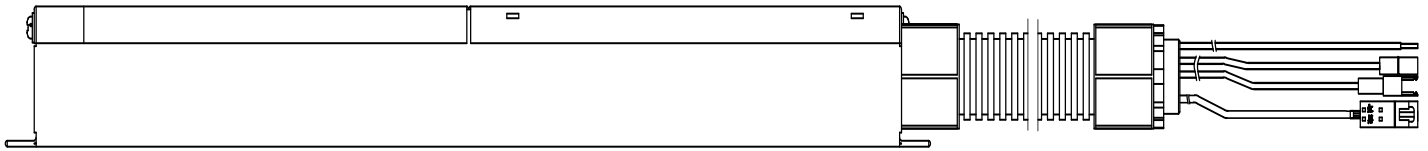

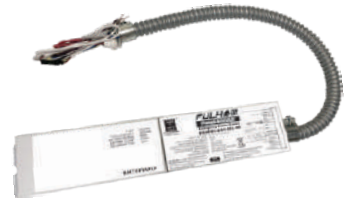

FHUPS1-UNV-25L-SD



Wiring Diagram 1

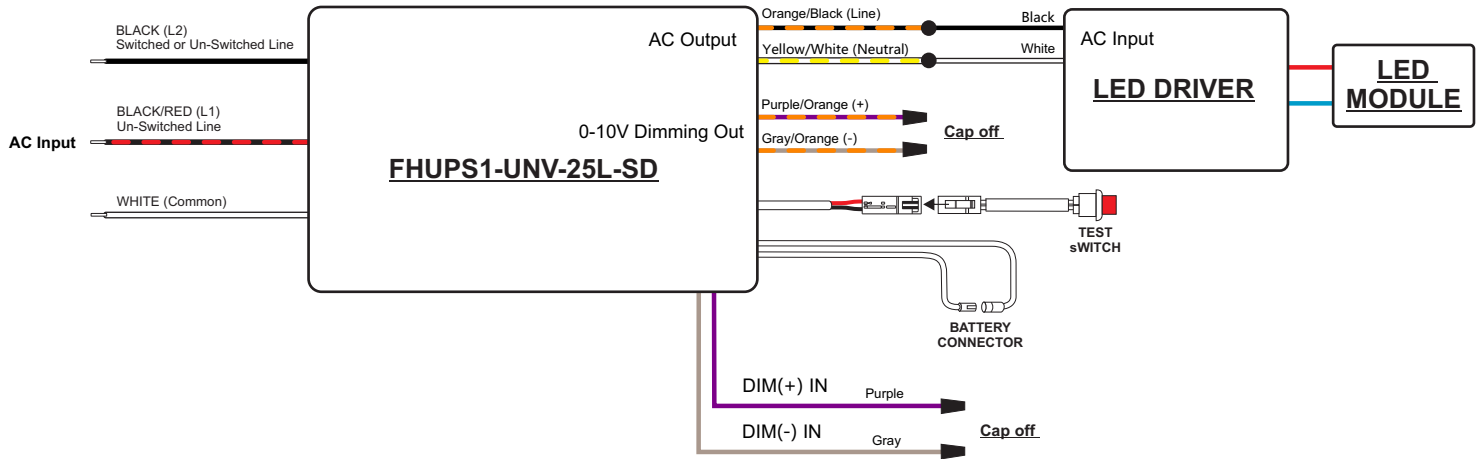

For LED Driver with an input power less than 25W(45VA) and Non 0-10 dimming function

Wiring Diagram 2

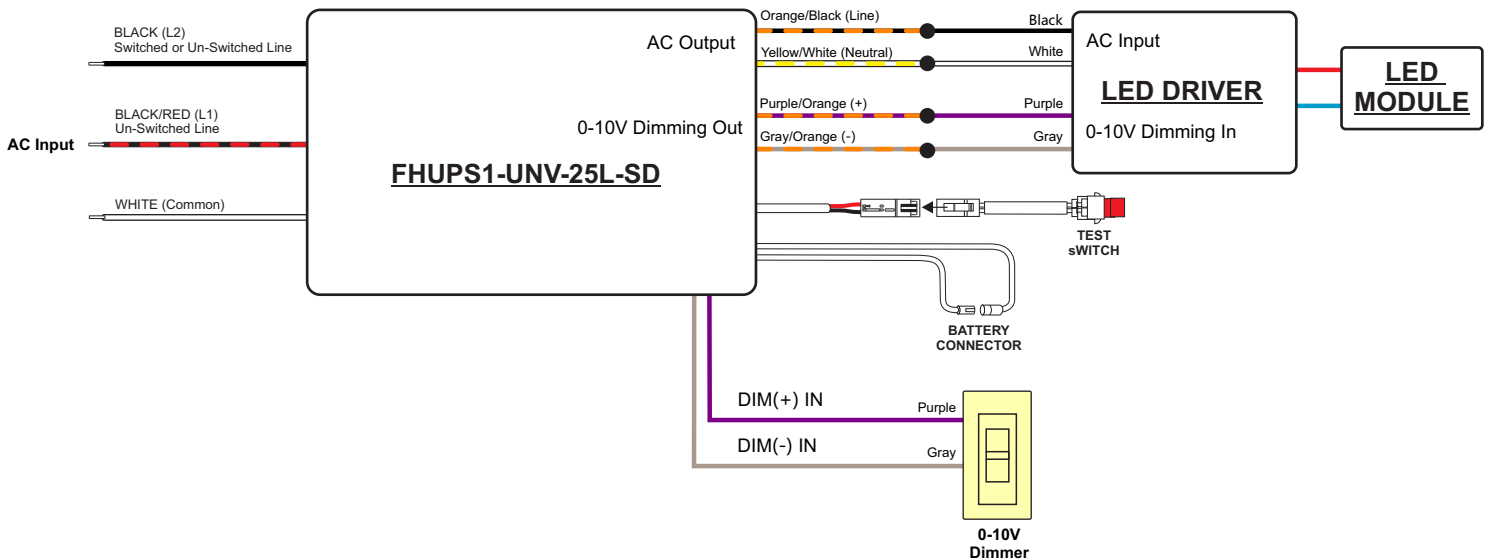

For LED Driver with an input power less than 150W(170VA) and have 0-10 dimming function



FHUPS1-UNV-25L-SD



Wiring Diagram 3

Wiring one single luminaire without 0-10V dimming

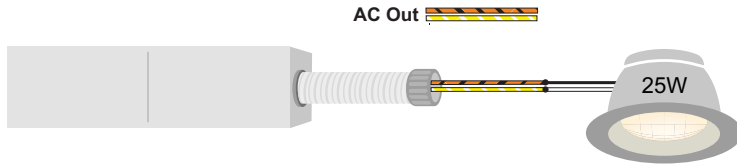

- One 25W luminaire powered at 100% during emergency

Wiring Diagram 4

Wiring multiple luminaires with 0-10V dimming

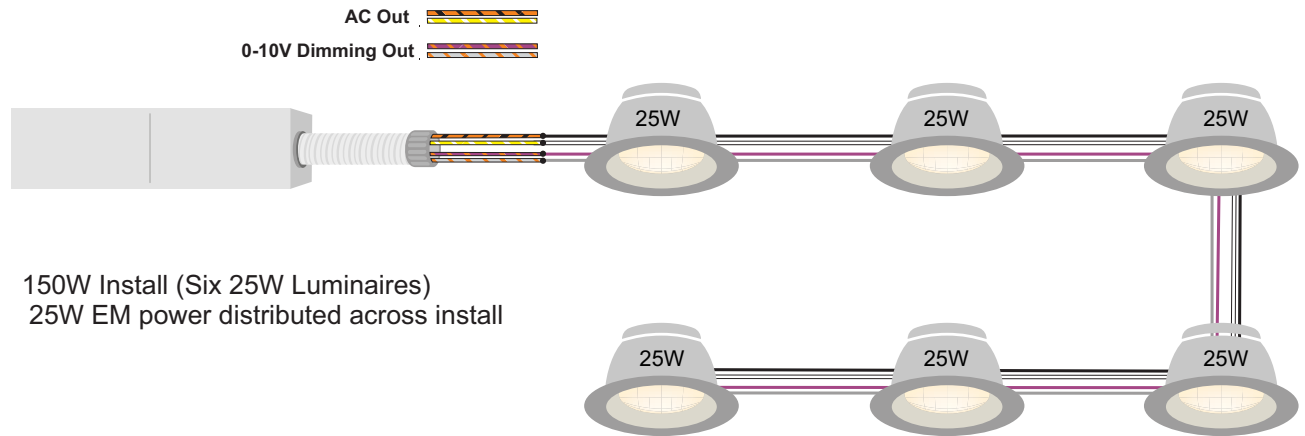

- 150W Install (Six 25W Luminaires)
- 25W EM power distributed across install

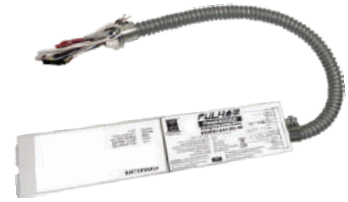

FHUPS1-UNV-25L-SD



TEST SWITCH INDICATOR STATUS:

LED Indicator Status	EM Driver Status/Mode
● Solid Green	System OK/AC OK (Self-diagnostic Enabled or Disabled)
● Slow Flashing Red, 4s on/1s off	Battery not detected, check battery switch or connection.
● Flashing Red, 1s on/1s off	Battery failure, replace battery.
● Flashing Green, 2s on/2s off	Self-diagnostic test underway.
● Fast Flashing Red, 0.1s on/0.1s off	Abnormal driver performance, replace driver.
● None. Both LEDs OFF	Normal working in EM mode
● Very Slow Flashing Red, 1s on/7s off	OTP or other internal protections triggered.

*Notes: OTP = Over Temperature Protection; ensures max temperature ratings are not exceeded.

TEST SWITCH OPERATIONS:

1.EM Test: Press and hold test button to enter EM mode for testing, in all normal AC powered situations including low power standby modes.

2.Manual Self-Diagnostic:Battery voltage greater than 20.5 hours ,or change for 12 hours. quickly press the test button three times within three seconds to force the controller enter a Self-Diagnostic cycle. To quit the self-diagnostic cycle after engaged press and hold the test button for ten seconds.

3.Enable/Disable Auto Self-Diagnostic: Press and hold the test button for two seconds, then release and quickly press the test button two times, then release and press and hold the test button for two more seconds. When properly executed the indicator on the test button will display the appropriate Enable/Disable status. A flashing of 2.5s ON/0.5s OFF means "Enabled", while a flashing of 0.5s ON/2.5s OFF means "Disabled". Once Enable/Disable is set the status color on the test button will remain the same throughout normal operation (refer to Indicator Status Table).

Programming:

Unless otherwise programmed the output will self-program to the maximum rating of the battery. This EM driver can be programmed using the Fulham SmartSet TPSB-100(E). Programming features include the following:

OTP Protection

Enable / Disable Self-Diagnostic



SmartSet Software



TPSB-100(E) SmartSet Controller



FHUPS1-UNV-25L-SD



IP20



GENERAL INSTALLATION GUIDELINES FOR LED EMERGENCY MICRO INVERTER

IMPORTANT SAFE PRACTICES

When using electrical equipment and this lighting device basic safety precaution should be followed at all times including but not limited to the following:

PLEASE READ CAREFULLY AND FOLLOW ALL INSTRUCTIONS FOR YOUR OWN SAFETY

IMPORTANT: Do not connect battery until fixture is installed.

IMPORTANT: An un-switched AC power source of 100VAC to 277VAC is required.

This device is designed for use in fixtures listed for dry and damp locations.

CAUTION: Make sure all electrical connections conform to the National Electrical Code and all applicable local regulations.

CAUTION : Do not let power supply cords touch hot surfaces.

CAUTION : Do not mount near gas or electric heaters.

CAUTION: Do not use outdoors.

CAUTION: Battery is rechargeable LiFePO4 type and must be recycled or disposed of properly. Do not use this emergency driver with accessory equipment other than recommended by manufacturer; failure to follow this may cause an unsafe condition. Servicing should only be performed by qualified service personnel. Do not use this emergency driver for other than intended use.

CAUTION: Equipment should be mounted in locations and at heights where it will not readily be subjected to tampering by unauthorized personnel.

IMPORTANT: The output EM power will be the maximum of connected battery unless programmed to a lesser value. EM output power will not exceed the battery rating.

IMPORTANT: Indicator (LED light) illuminated indicates battery in charge mode when AC power is applied.

It is recommended and required by applicable code to test emergency function to ensure proper operation of the system; push the test switch for thirty (30) seconds every 30 days to ensure the emergency driver is functioning as LED light source illuminated. Conduct a ninety minute (90) discharge test one time (1) per year; LED light source should be illuminated for a minimum of ninety minutes (90).

ASSEMBLY and FIELD INSTALLATION WIRING: WARNING: AC power must be off before proceeding with assembly or installation of emergency driver.

TESTING SYSTEM: The emergency battery requires a charge minimum of one (1) hour before testing the circuit. A full charge requires twelve (12) hours (Refer to battery chart).

Fulham Head Quarters:
Fulham Co., Inc
12705 South Van Ness Ave.
Hawthorne, CA 90250

Manufacturer:
North China
Fulham Electronic Co. Ltd.
4th Floor, Building#18, co.park.No.8 Heying Road, Changping District, Beijing, P.R. China.

SAVE THESE INSTRUCTIONS

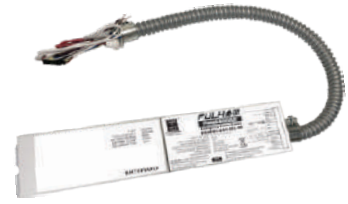

FHUPS1-UNV-25L-SD



IP20



Guidelines

Grounding

- Inverter must be grounded by means of the inverter case.

Overload Protection

- If the maximum output power exceeded, the inverter will be switched off automatically; after the elimination of the overload, the normal operation will be restored automatically.
- If it is overloaded during emergency, it needs to be AC powered again after triggering the protection.

Load

- Fulham FHUPS1-UNV-25L-SD inverter can operate a maximum 25W, PF>0.55 (45VA) load with no 0-10V dimming function; or it can also operate a maximum 150W (170VA) load with 0-10V dimming function, and the dimming function is required to be able to dim the load below 25W(45VA).

Short-circuit protection

- In case of a short circuit, the inverter switches to protection mode. After the removal of the short-circuit the inverter will recover automatically.
- In case of short circuit during emergency, power on again after the short circuit fault is removed.

Under-Voltage protection

- When the line voltage is reduced to the critical voltage, the inverter will instantly provide emergency power to the load.

Hot Swapping

- This inverter does not support hot swapping of the LEDs

Remote Mounting

- Up to 164ft (50m) with 18AWG. Contact Fulham for higher remote distance.

Warranty

- Reference Fulham's limited Warranty: <https://cdn.fulham.com/PDFs/Limited-Warranty.pdf>

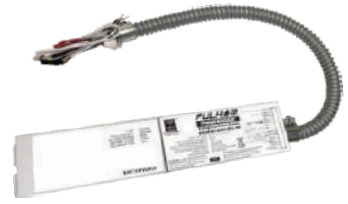

FHUPS1-UNV-25L-SD



Part Number Matrix

FH **UPS** **1** **UNV** **25** **L** **SD**

FH = Fire Horse

UPS= Uninterruptible Power Supply

1 = UPS Order Number

Input Voltage

UNV= 100V-277V

Maximum Output Power

25 = 25W

Case Type

L= Long or Linear

Additional Options

SD= Self Diagnostic

Product Image:

FHUPS1-UNV-25L-SD

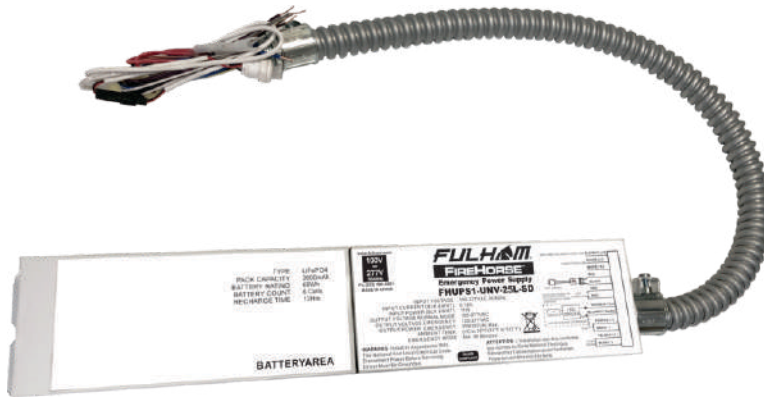

Packaging

Master Carton

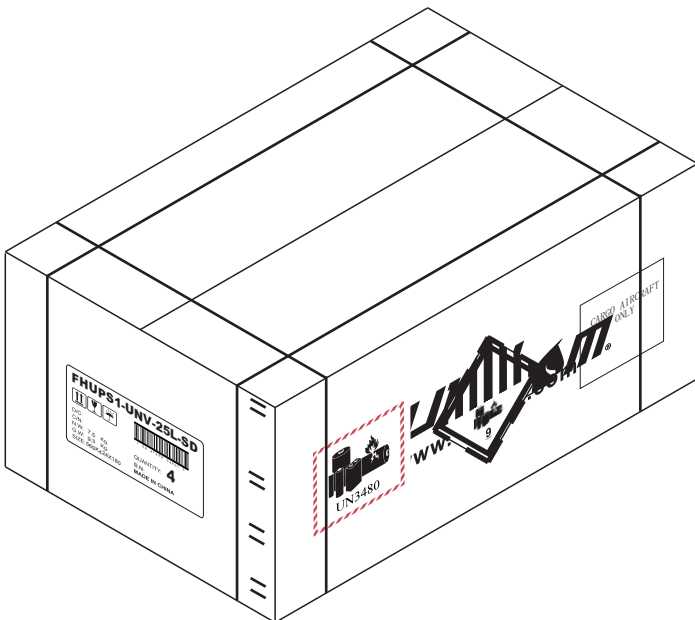

OUTER DIMENSION		
L	W	H
22" (559mm)	17" (431mm)	6.9" (175mm)
Net Weight	Gross Weight	QUANTITY
16.53lbs. (7.5kg.)	20.5lbs. (9.3kg)	4pcs.