



SOSEN LED Driver, Your Smart Choice

Specifications

SS-120CNL Series LED Driver

Model: SS-120CNL-130*

Description: 120W LED Driver

Rev.: V03

Release Date: 2020-04-02

SS-120CNL Series LED Driver

SOSEN
LED DRIVER



LED DRIVER

CNL Series



Features:

- Efficiency up to 93%
- Isolated dimming:0-10V,PWM,Resistor
- Optional aux : 12V/0.2A
- IP65
- Protections: SCP/OTP/OVP
- Surge protection: L/N-PE: 4kV, L-N: 4kV
- Warranty: 5 years



IP65

Description :

SS-120CNL series is a 120W circular non-isolated constant current driver. This series of products is designed for LED lighting. It is specially designed for industrial and mining lamps, high pole lights. It has isolated dimming function. High efficiency, compact housing design, fully potted thermal silica to ensure heat dissipation and waterproof performance, high reliability, high cost performance and so on.

Model List:

Model	AC Input Range	Max. Pout	Vout Range	Full Power Vo Range	Iout	THD(Typ.)	PF(Typ.)	Eff.(Typ.)	Max.Tc
SS-120CNL-130*	90-305Vac	120W	90-130V	120-130V	0.7-1.0A	7%	0.96	93%	90°C

1.Default tested at 220Vac, full load, Ta 25°C.

2.“*”Optional B or space in the place of * means additional function.

- Space is the base model without any optional function;
- Suffix B for model with 3-in-1 dimming (1-10V, PWM, Resistor);
- Suffix BH for model with 3-in-1 dimming (0-10V, PWM, Resistor)+AUX.

SS-120CNL Series LED Driver

Input Characteristics:

Parameter	Min.	Typ.	Max.	Remark
Rated AC Input Range	100Vac		277Vac	
AC Input Range	90Vac		305Vac	Reference derating curve
Input Frequency Range	47Hz	50/60Hz	63Hz	
Max Input Current			1.5A	100Vac, Full load
Max Input Power			150W	100Vac, Full load
Max Inrush Current(120Vac)			60A	Cold start
Max Inrush Current(220Vac)			80A	Cold start
Max Inrush Current(277Vac)			100A	Cold start
Standby Power			0.5W	220Vac/50Hz, No load
Power Factor	0.95	0.97		220Vac/50Hz, Full load
	0.90			100-277Vac/50Hz, 70%-100% load
THD		7%	10%	220Vac/50Hz, Full load
			20%	100-277Vac/50Hz,70%-100% load

SS-120CNL Series LED Driver

Output Characteristics:

Parameter	Min.	Typ.	Max.	Remark
Output Voltage Range	90V		130V	
Rated Output Voltage	120V		130V	$P_o=V_o \cdot I_o=120W$, Full load
Rated Output Current	0.92A		1.0A	1.0A for 120V, 0.92A for 130V
Current Adjustable Range(AOC)	0.7A		1.0A	
No Load Voltage			180V	
Efficiency @120Vac	89.0%	91.0%		Output 130V/0.77A
Efficiency @220Vac	91.0%	93.0%		Output 130V/0.77A
Efficiency @277Vac	91.5%	93.5%		Output 130V/0.77A
Output Current Tolerance	-5%		+5%	
Output Current Ripple(PK-AV)		5%	10%	
Start-up Current Overshoot			10%	Full load
Start-up Time			1.0S	120Vac
			0.5S	220Vac
Line Regulation	-2%		+2%	Full load
Load Regulation	-2%		+2%	
Temperature Coefficient	-0.03%/°C		+0.03%/°C	Tc: 0°C~90°C
OTP	90°C	100°C	110°C	Tc, Decreases output current, returning to normal after over temperature is removed.
Short Circuit Protection			10W	Driver will not be damaged

SS-120CNL Series LED Driver

Other Characteristics:

Parameter		Min.	Typ.	Max.	Remark
Aux Power	12V	10.8V	12V	13.2V	
	12V			200mA	
1-10V Dimming (Optional)	Dim Vmax	0V		12V	
	Dim Range	10%Iomax		100%Ioset	
	Rec.Dim Range	1V		10V	
PWM Dimming (Optional)	PWM High	9.8V		10.2V	
	PWM Low	0V		0.3V	
	Frequency	1KHz		2KHz	
	PWM Duty	10%		100%	
Resistor Dimming (Optional)	Resistance	10Kohm		100Kohm	
	Dim Range	10%Iomax		100%Ioset	
Dim to Off (Optional)	Dim-off	0.5V	0.7V	0.9V	
	Dim Turn on	0.7V	0.9V	1.0V	
Lifetime(Tc≤72°C)		≥62,000 hours		80% load,220Vac	
MTBF		200,000 hours		220Vac,Full load, Ta=25°C (MIL-HDBK-217F)	
IP Grade		IP65			
Tc		90°C			
Warranty		5 years		Refer to life time drawing	
Net Weight		860g			
Dimension		Φ130.2mm*61.8mm		D x H	

NOTE: All the parameters above are tested Ta 25°C, unless specified.

SS-120CNL Series LED Driver

Environmental Requirements

Parameter	Min.	Typ.	Max.	Remark
Operating Temperature(Tcase)	-40°C	25°C	+90°C	
Storage Temperature	-40°C	25°C	+85°C	
Operation Humidity	10%RH		90%RH	
Storage Humidity	5%RH		95%RH	
Altitude	-65m		4000m	

Safety and EMI/EMS Standards

Certification	Standard	Status	Remark
UL/cUL	UL8750	✓	
TUV	EN 61347-2-13:2014 EN61347-1:2008+A1:2011+A2:2013 EN62493:2015	✓	
RCM	AS/NZS61347.2.13	✓	
BIS	IS15885:2012 Part 2 Sec 13		
CCC	GB 19510.14-2009	✓	
CE	EN 61347-2-13:2014 EN61347-1:2008+A1:2011+A2:2013	✓	

EMI/EMS	Criterion	Remark
Conduction Emission	EN55015:2013+A1:2015	
Radiation Emission	EN55015:2013+A1:2015	
Harmonic Current Emissions	IEC/EN 61000-3-2	Class C
Surge	IEC/EN61000-4-5	Difference mode 4kV, Common mode 4kV,Criterion B
Ring Wave	IEC/EN 61000-4-12	Difference mode 4kV, Common mode 4kV,Criterion B

SS-120CNL Series LED Driver

Safety Test Items:

Safety test items	Technical Indicators			Remark
Insulation Requirements	UL Insulation Requirements	TUV Insulation Requirements	CCC Insulation Requirements	
Input-Case	1600Vac	1500Vac	1875Vac	Basic insulation
Input-Dim	1600Vac	3000Vac	3750Vac	Reinforced insulation
Output-Dim	1600Vac	3000Vac	3750Vac	Reinforced insulation
Dim-Case	500Vac	500Vac	500Vac	
Insulation Resistance	≥10MΩ			Input-Dim, Test voltage:500Vdc
Ground Resistance	≤0.1Ω			25A/1min
Leak Current	≤0.75mA			277Vac

NOTE:

1. SOSEN warrants the LED Driver itself meets with EMC standard. However, LED Driver's EMC should be re-checked when integrated into lighting systems due to unexpected interference as component.
2. Please short Line and Neutral, LED+ and LED-, Dim+ and Dim - when Hi-pot test.
3. The CCC withstand voltage test needs to disconnect the built-in lightning protection tube. According to the IEC 60598-1:14 standard section 10.2, the "built-in lightning protection tube" can be marked on the nameplate to disconnect the discharge tube on testing.

Performance Curves:

Input Inrush Current

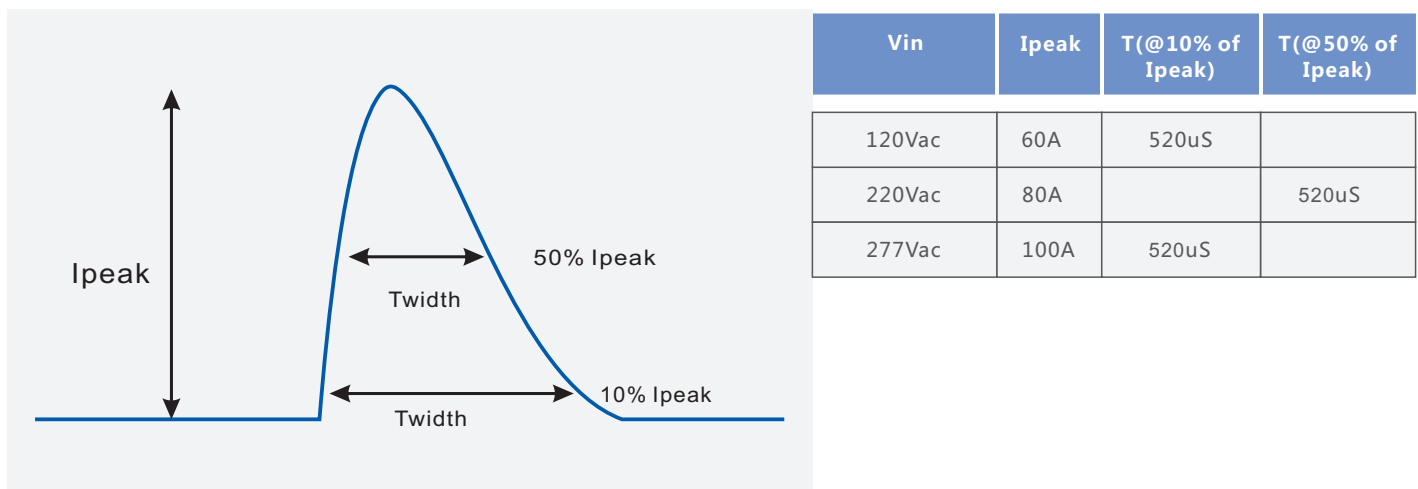

SS-120CNL Series LED Driver

Performance Curves:

Output Voltage Vs. Output Current(Dim/AOC Window)

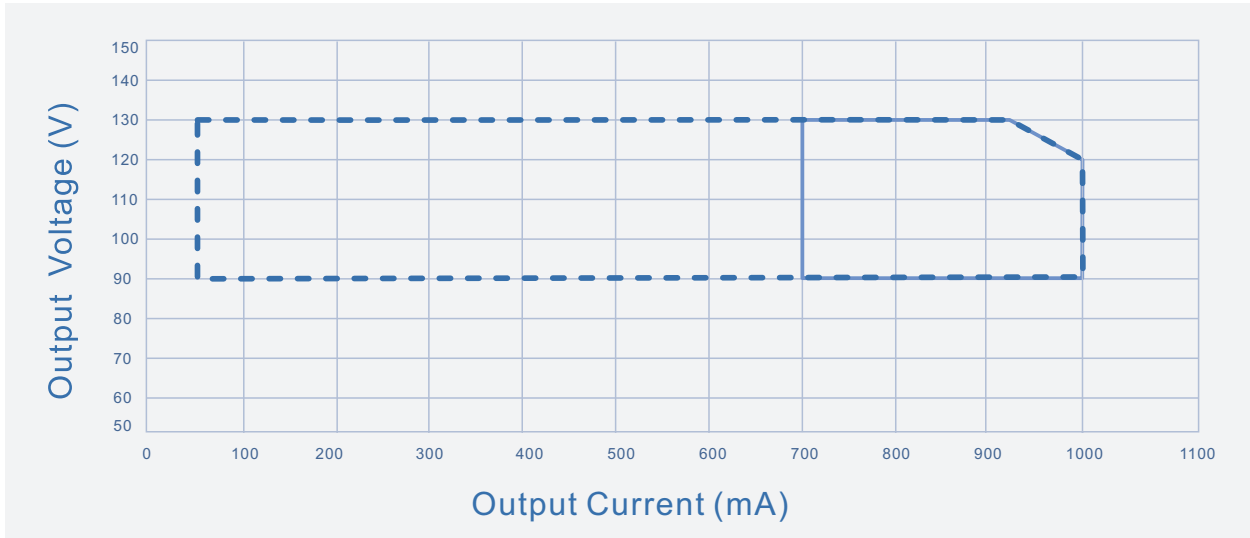

----- Dimming Window ————— AOC Window

Efficiency Vs. Output Voltage (Vin=120Vac)

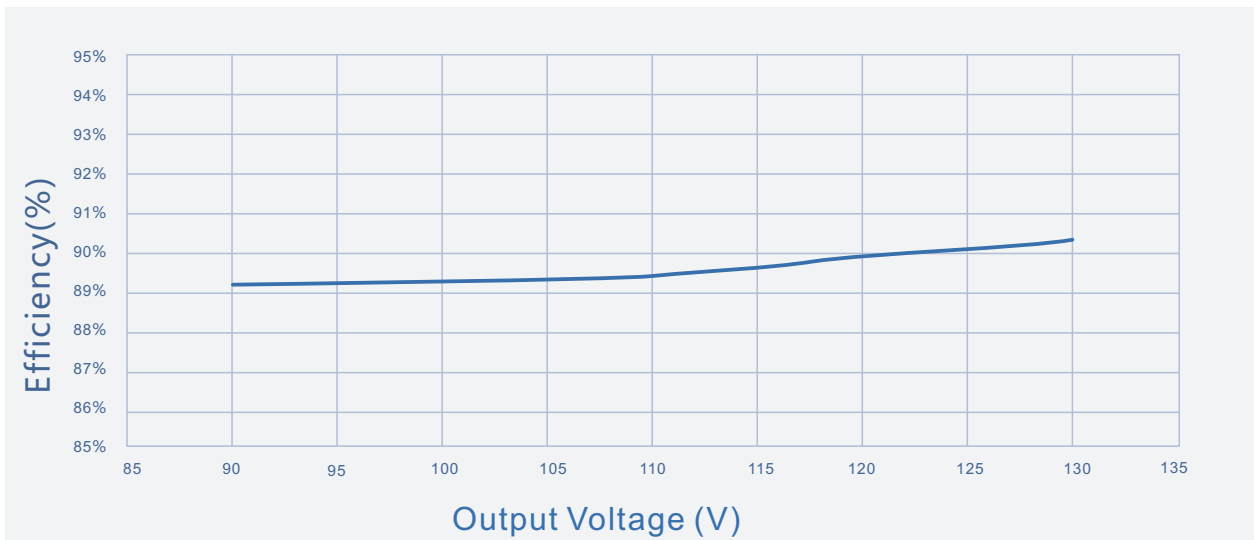

————— Io=920mA

SS-120CNL Series LED Driver

Performance Curves:

Efficiency Vs. Output Voltage ($V_{in}=220V_{ac}$)

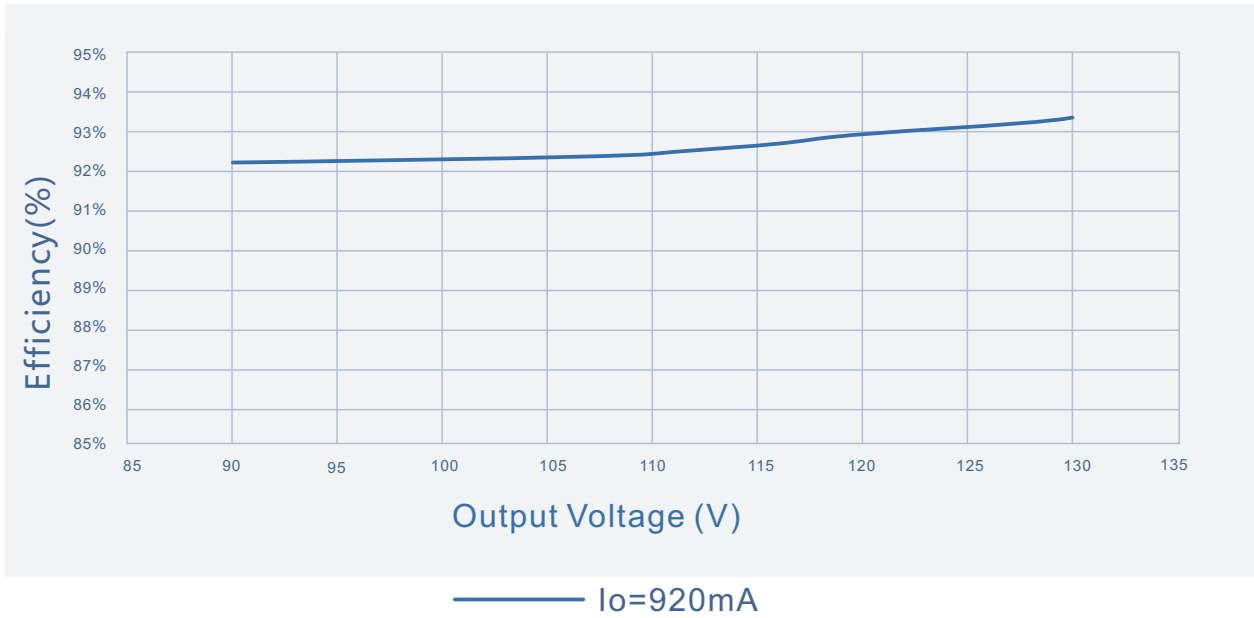

Efficiency Vs. Output Voltage ($V_{in}=277V_{ac}$)

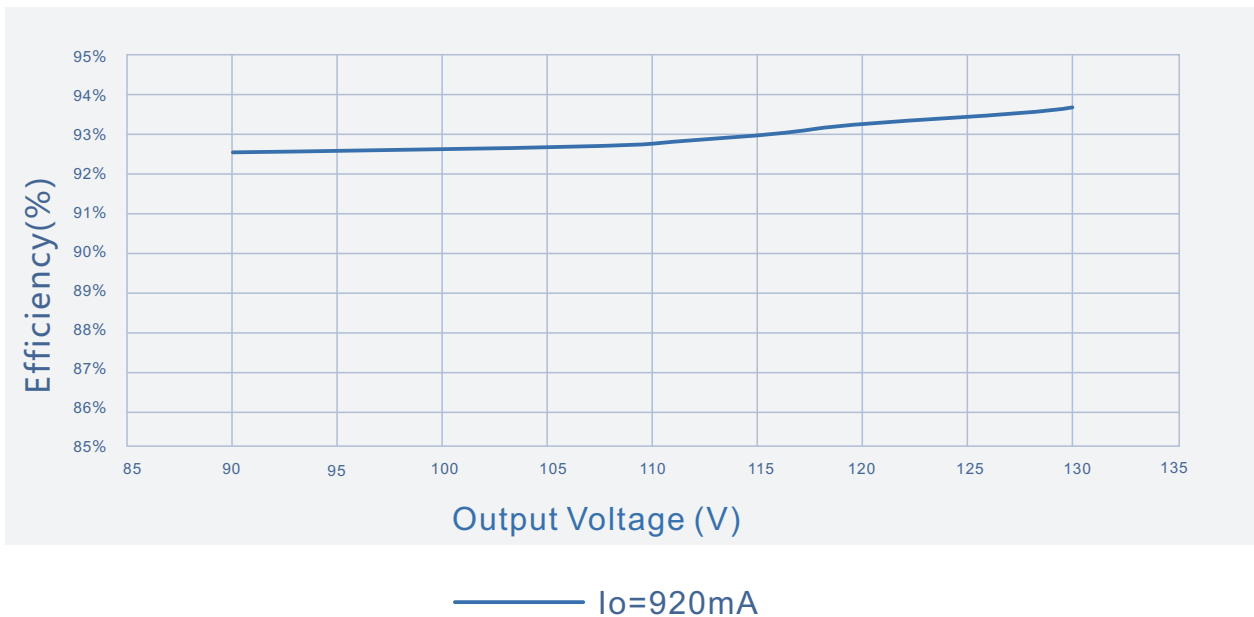

SS-120CNL Series LED Driver

Performance Curves:

Power Factor Vs. Output Power

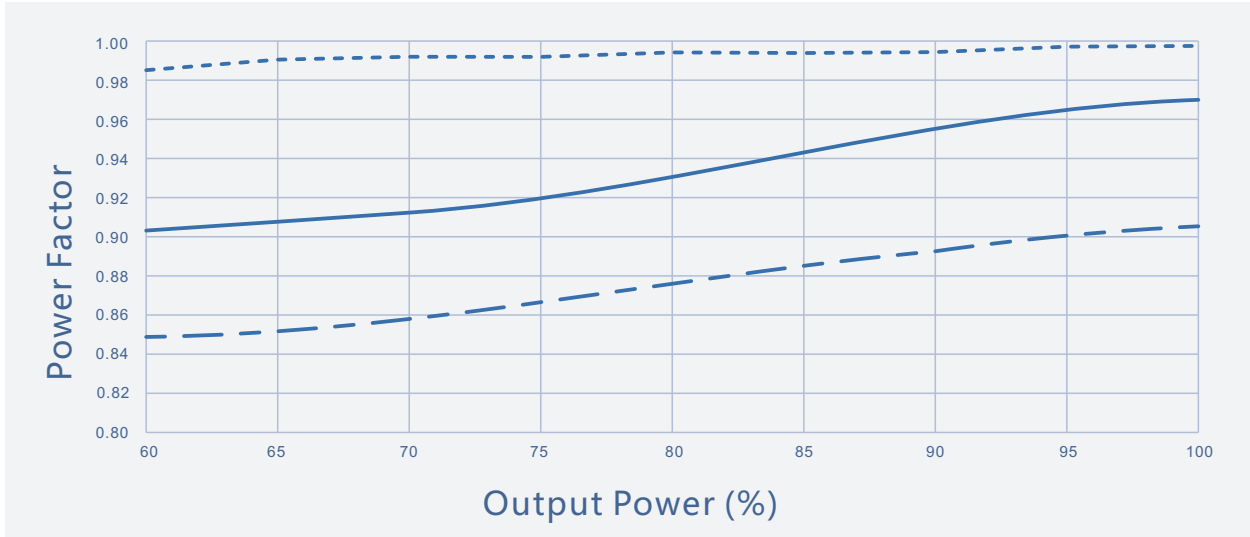

----- Vin=120Vac ——— Vin=220Vac - · - · Vin=277Vac

THD Vs. Output Power

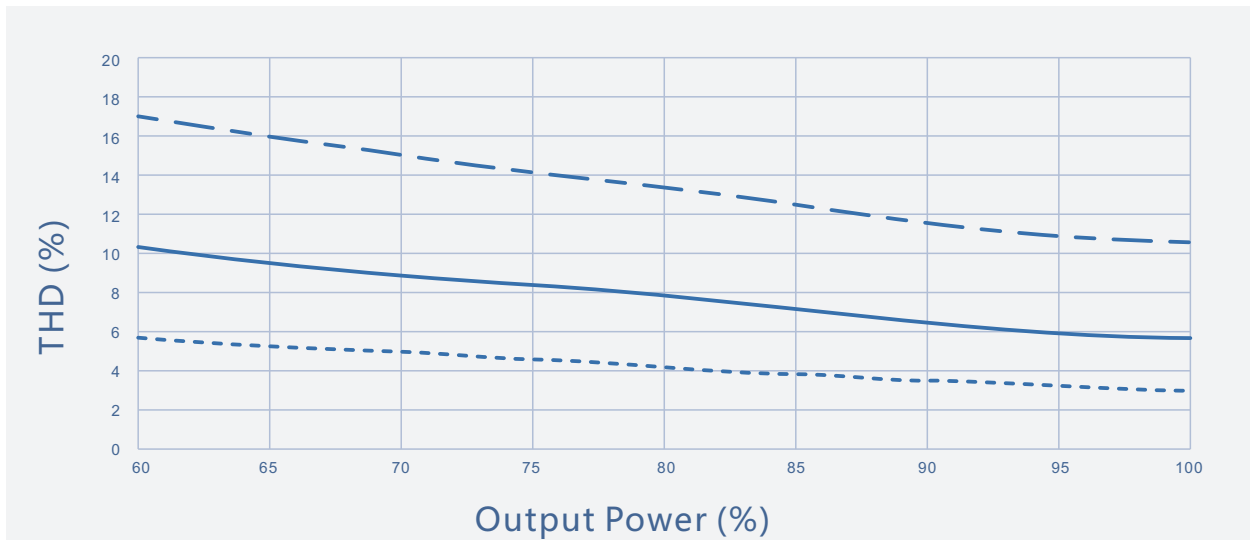

----- Vin=120Vac ——— Vin=220Vac - · - · Vin=277Vac

SS-120CNL Series LED Driver

Performance Curves:

Output power Vs. Input Voltage (Ta Max.60°C)

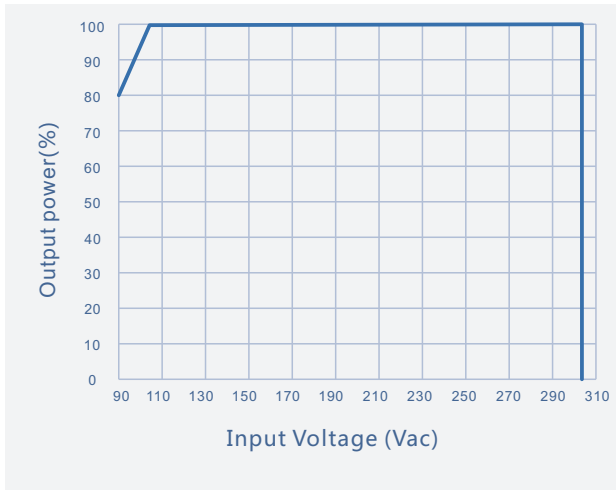

Output power Vs. Case Temperature

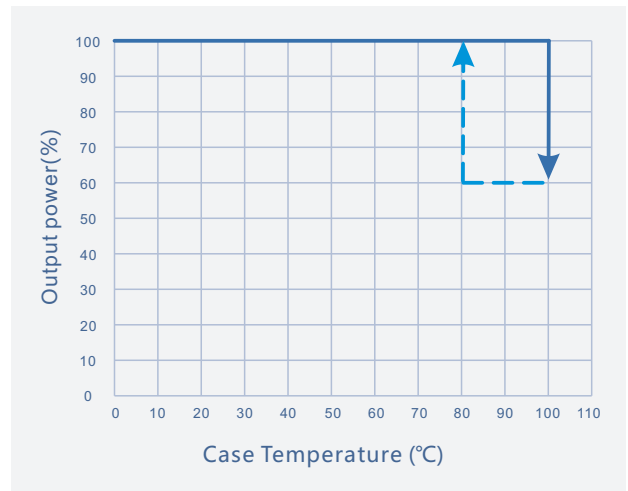

Output Power Vs. Dimming

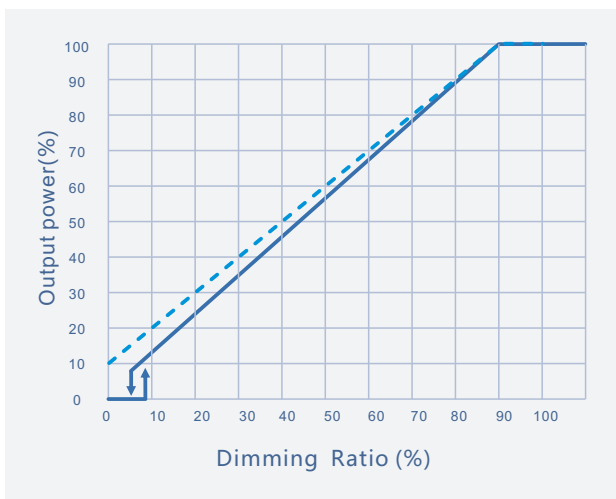

—— BH Type - - - - B Type

Lifetime Vs. Case Temperature

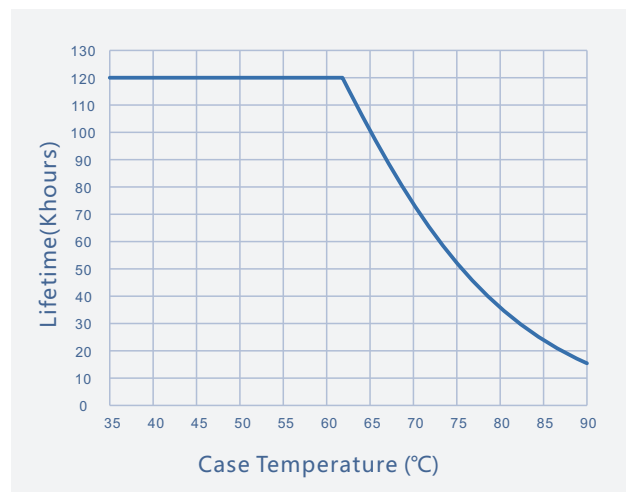

SS-120CNL Series LED Driver

Mechanical characteristics(Unit: mm)

INPUT

- ACL
- ACN
- \oplus
- AOC

LED DRIVER

OUTPUT

- V+
- V-
- DIM+ Dimming
- DIM-
- Vaux+ AUX Power

AC Input Cable(Lead Length outside enclosure 300±10mm):
 UL model: SJTW,3*0.824mm²,O.D: 7.8mm,Black:L,White:N,Green: \oplus
 Euro model: H05RN-F,3*1.0mm², O.D:7.4mm,Brown:L, Blue:N, Yellow/Green: \oplus

DC Output Cable(Lead Length outside enclosure 300±10mm):
 UL model: SJTW,2*0.824mm²,O.D: 7.6mm,Red:V+ , Black:V-
 Euro model: H05RN-F,2*1.0mm², O.D:7.0mm, Brown:V+, Blue:V-

DIM Power Cable(Lead Length outside enclosure 220±10mm):
 UL/Euro model(BH Type): UL 21996#22AWG , O.D: 6.0mm , Purple: DIM+ , Gray: DIM- , Pink: Vaux+
 UL/Euro model(B Type): UL 2733#22AWG , O.D: 6.0mm , Purple: DIM+ , Gray: DIM- , Pink: Vaux+ ,Black/White: Vaux-

Name Description	Standard code	mm(In.)
Input line hole	A	11.5(0.45)
Fixed Screw Diameter	4-B	Φ7.0(0.28)
Case Diameter	D	Φ132(5.2)
Height	H	61.8(2.43)
ADJ Hole	I	ADJ./IO
Ring Hole	Z	M10*1.5(Depth 18mm) G1/2(Depth 17mm)
Ring Fixed Hole	R	M4*0.7
Dim cable hole	T	Optional
Fixed Size	W	113(4.45)
TC point position	X	20.4(0.8)
TC point position	Y	2.0(0.08)

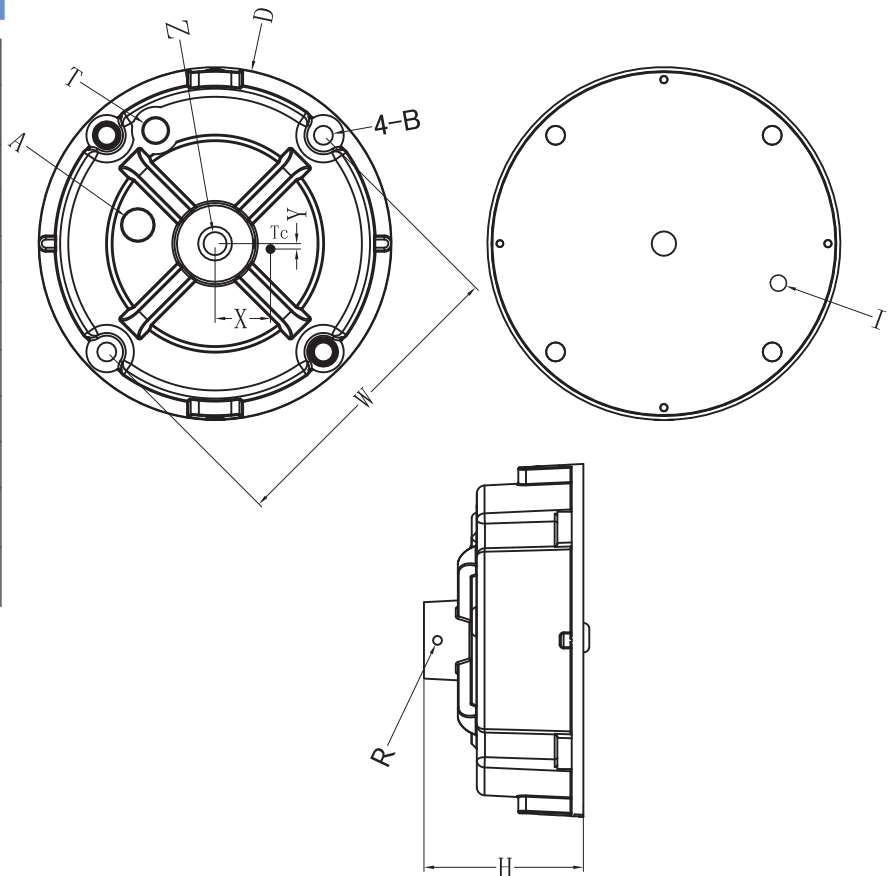

SS-120CNL Series LED Driver



Installation Tips

1. Highly recommended to seal the adjustable hole with silicon glue(#704 preferred) after adjusting the driver's output current. Torsion with proper strength to avoid permanent damage to the potentiometer inside.
2. Dimming leads should be capped if not in use to avoid dimming circuit damage caused by external signals.
3. Voltage resistance of LED lamp beads and aluminum substrates should be >3KV.
4. Creepage distance of the aluminum substrate trace safety is >5mm.
5. LED+ and LED-climbing distance on the aluminum substrate is >1.8mm.
6. Minimize the copper area on the aluminum substrate, reduce the junction capacitance, and reduce the leakage current.
7. LED lamp bead arrangement is recommended first and then string.

Package

- Outside carton dimension: L×W×H =500mm×390mm×170mm;
- 10PCS/Carton;
- Net weight/PC: 0.86kg;Gross weight/Carton: 9.6kg;
- Please refer to the product name, model number, manufacturer identification, quality inspection certificate, manufacturing date Etc. on the package. and LED power supply instruction manual in the package.

Transportation

Packaging is designed suitable for transportation by trucks, vessels and flights. The products should be shielded from direct sunshine, loaded/unloaded with caution.

Storage

The product storage meets the standard of the GB 3873 - 83.
Products should be rechecked if stock for over 1 year before installation.

RoHS

Products comply with European directive 2011/65/EC.

REVISION HISTORY

Version	Description of Change	Changed Date	Remark
V00	Original release	2019/07/22	
V01	Update installation tips	2019/09/18	
V02	Add auxiliary source	2019/11/06	
V03	Update Structure Dimension Characteristics	2020/04/02	

