



T8 LED Tube Manual

Thanks for using our products! Before installing, please read the manual carefully.

Product Certification: UL

ELECTRICAL RATINGS:

Model	Input Ratings				Tube Length
	Voltage (Vac)	Frequency (Hz)	Current (mA)	Wattage (W)	
CLT99-15WT8FG-YY-AB	100-277	50/60	129	15	4ft
CLT99-17WT8FG-YY-AB	100-277	50/60	189	17	

Note: Where “YY” stands for CCT(K), for example: 3000K marked as 30K, 3500K marked as 35K, 4000K marked at 40K, and 5000K marked as 50K.

1. Environmental Conditions:

The T8 LED tube cannot be installed in rain, wet areas, dusty areas, flammable areas, or combustible environments. Please confirm the light fixture meets the level of protection requirements if necessary.

2. Installation Requirements:

The installation should be done by a licensed electrician. If the tube is Type B, please take the ballast and starter out of the light before installation. Operating temperature is -20°C~+40°C.

3. Installation Instruction:

The T8 tube can only work with the matched voltage.

Type A:

Please check the connect instruction graphics as following:

- **First Step:** Cut off the power before installation
- **Second Step:** Take down the florescent lamp
- **Third Step:** Install the LED tube

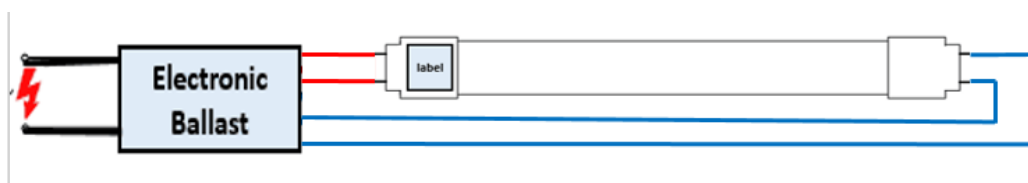

Type B (Single Ended):

To replace the traditional florescent tube, please remove the ballast, remove the starter and reconnect the electric circuit. Please check the connect instruction graphics as following:

- **First Step:** Cut off the power before installation
- **Second Step:** Take down the florescent lamp, starter and cut off the power line which is connected with the ballast

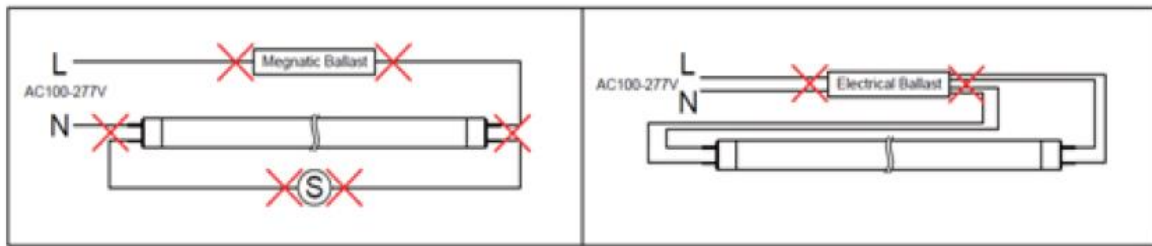

- **Third Step:** Install the LED tube and make the electrical connection

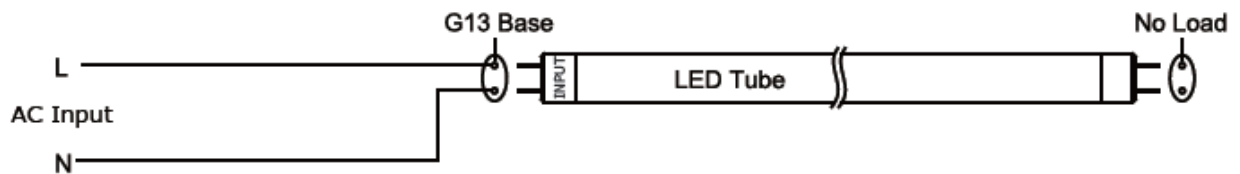

More Than One Set Installation Graphic:

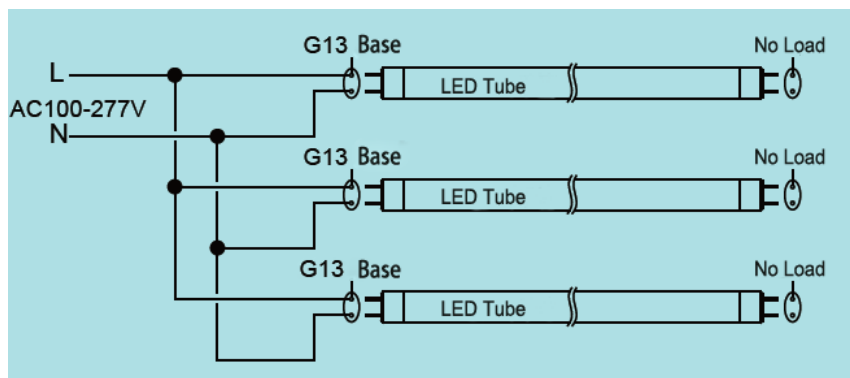

- **Fourth Step:** Affix the field applied label to the light fixture. Then install the tube. The tube is single port wiring connection.

Type B (Double Ended):

To replace the traditional florescent tube, please remove the ballast, remove the starter, and reconnect the electric circuit.

Please check the connect instruction graphics as following:

- **First Step:** Cut off the power before installation
- **Second Step:** Take down the florescent lamp, starter and cut off the power line which is connected with the ballast

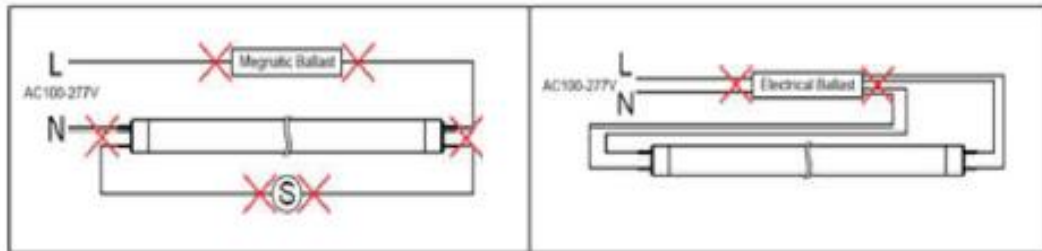

- **Third Step:** Install the LED tube and make the electrical connection

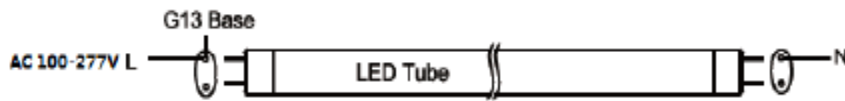

More than one set installation graphic:

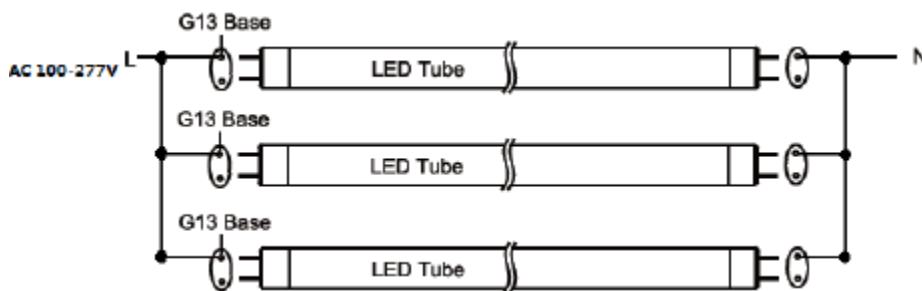

- **Fourth Step:** Affix the field applied label to the light fixture. Then install the tube. The tube is double port wiring connection



4. Warnings:

- i. Please check if the product is in good condition before installation.
- ii. The LED tube should not be knocked down or be replaced with a driver randomly.
- iii. Packed product should **not** be placed in wet areas, high temperature, flammable or combustible environments. They should be in a cool, dry environment.
- iv. **WARNING:** Risk of fire or electric shock. The electrical rating of these products is 100-277Vac. The installer must determine whether they have 100-277V at the luminaire before installation.
- v. **WARNING:** Risk of fire or electric shock. LED Retrofit Kit installation requires knowledge of luminaires electrical systems. If not qualified, do not attempt installation. Contact a qualified electrician.
- vi. **WARNING:** Risk of fire or electric shock. Install this kit only in the luminaires that have the construction features and dimensions shown in the photographs and/or drawings.
- vii. Do not make or alter any open holes in an enclosure of wiring or electrical components during kit installation.
- viii. **WARNING:** To prevent wiring damage or abrasion, do **not** expose wiring to edges of sheet metal or other sharp objects.
- ix. **WARNING:** To avoid potential fire or shock hazard, do **not** use this retrofit kit in luminaires employing shunted bi-pin lamp holders. **Note:** Shunted lamp holders are found only in fluorescent luminaires with Instant-Start ballasts. Instant-start ballasts can be identified by the words "Instant Start" or "I.S." marked on the ballast. This designation may be in the form of a statement pertaining to the ballast itself, or may be combined with the marking for the lamps with which the ballast is intended to be used, for example F40T12/IS. For more information, contact the LED luminaire retrofit kit manufacturer.
- x. Installers should **not** disconnect existing wires from lamp holder terminals to make new connections at lamp holder terminals. Instead, installers should cut existing lamp holder leads away from the lamp holder and make new electrical connections to lamp holder lead wires by employing applicable connectors.
- xi. This retrofit kit is accepted as a component of a luminaire where the suitability of the combination shall be determined by authorities having jurisdiction.