

300W

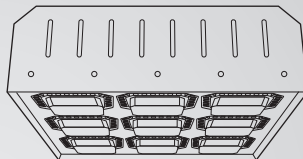

450W

Modular LED Light Fixture  
**Installation and Maintenance Manual**  
(2014)

# Content

Introduction	-----	2
Warning	-----	3
Installation		
A. Hanging Ring Mount	-----	4
B. Surface Mount	-----	5
C. Universal Hanging Bracket	-----	6
D. Mounting Bracket c/w Clapping Ring	-----	7
Wiring	-----	8
Specification	-----	9

# Introduction

Using only the highest quality components, the Modular LED Light Fixture is designed for industrial applications where reliability and performance are critical as the bulb maintenance is difficult or impossible, not to mention the high cost.

Every component of the Modular LED Light Fixture has been carefully engineered to provide the most reliable performance and bring across many benefits of utilizing solid state lighting technology in industrial applications.

Modular LED Light Fixture is rated IP65 with further option to upgrade to IP67, suitable for both indoor and outdoor use.

## Product Features:

- Individual high performance LED light engine with Cree XT-E LED delivering 100 lumen per watt.
- Patented thermal management allows -30°C to 55°C ambient working temperature.
- Easiest installation and maintenance experiences guaranteed:
  - Easiest one-man operation;
  - Hinged LED light engine holder;
  - Quick connector between LED light engine and driver.
- 5 years warranty, up to 150,000 hours long life.
- Dimmable and motion sensor control compatible.

# Warning

To avoid the risk of fire, explosion, or electric shock, this product should be installed, inspected, and maintained by a qualified electrician only, in accordance with all applicable electrical codes.

To avoid electric shock:

- Be certain electrical power is OFF before and during installation and maintenance.
- Luminaire must be connected to a wiring system with an equipment-grounding conductor.
- Make sure the supply voltage is the same as the rated luminaire voltage.
- Do not operate in ambient temperatures above those indicated on the luminaire nameplate.
- Avoid to use in environments containing sulfur, chlorine, or other halides, methyl acetate or ethyl acetate, cyanoacrylates, glycol ethers, formaldehyde or butadiene.

# Installation

For high performance and long term reliability, the light should be installed in free air.

## A. Hanging Ring Mount

1. Hang the ring to the field supplied by the mounting hook or chain.
2. Secure the safety rope hook to the field supplied by the second mounting point or to the main mounting point in case the second point is not provided.
3. Wiring.(Connect supply wires to luminaire wire leads per the wiring diagram using methods that comply with all applicable codes.)

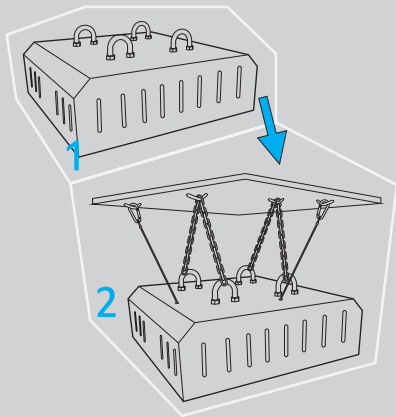
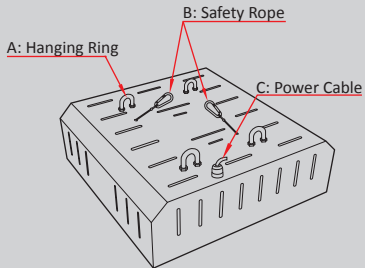

# Installation

For high performance and long term reliability, the light should be installed in free air.

## B. Surface Mount

1. Bolt the anchor plate to the ceiling securely.
2. Hook the fixture to the anchor plate.
3. Insert the screw to secure the hook to the anchor plate.
4. Secure the safety rope hook to the field supplied by the second mounting point.
5. Wiring. (Connect supply wires to luminaire wire leads per the wiring diagram using methods that comply with all applicable codes.)

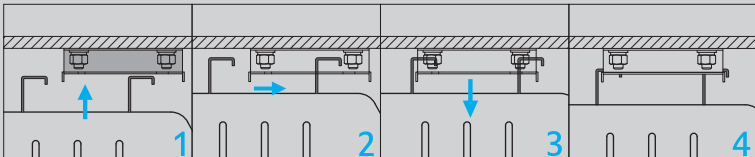
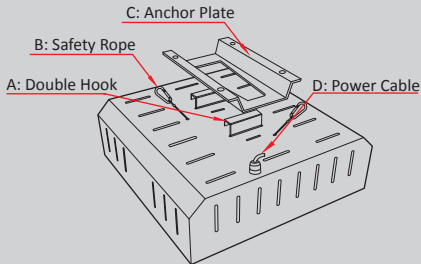

# Installation

For high performance and long term reliability, the light should be installed in free air.

## C. Universal Hanging Bracket

1. The angle plate allows 360° rotation and 10° per move.
2. Rotate the bracket to the desired angle and insert 2 screws to lock it.
3. Bolt the universal mounting bracket to the field mounting point. Bolt the center point before the two side points. Tighten the bolts to wrench tight.
4. Secure the safety rope hook to the field supplied by the second mounting point.
5. Wiring. (Connect supply wires to luminaire wire leads per the wiring diagram using methods that comply with all applicable codes.)

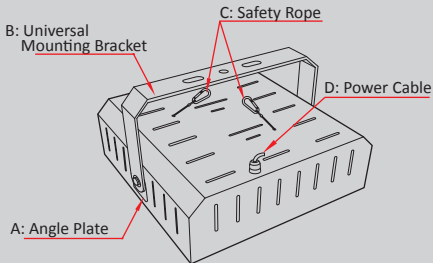

Note: The angle plate allows 360° rotation and 10° per move.

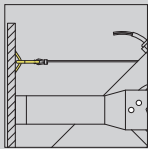
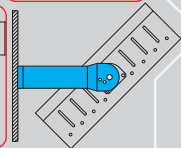
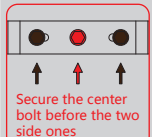

# Installation

For high performance and long term reliability, the light should be installed in free air.

## D. Mounting Bracket c/w Clapping Ring

1. The angle plate allows 360° rotation and 10° per move.
2. Rotate the bracket to the desired angle and insert 2 screws to lock it.
3. Insert bolts to lock the bracket with clapping ring to the pole arm, tighten the bolts to wrench tight.
4. Secure the safety rope hook to the field supplied by the second mounting point.
5. Wiring. (Connect supply wires to luminaire wire leads per the wiring diagram using methods that comply with all applicable codes.)

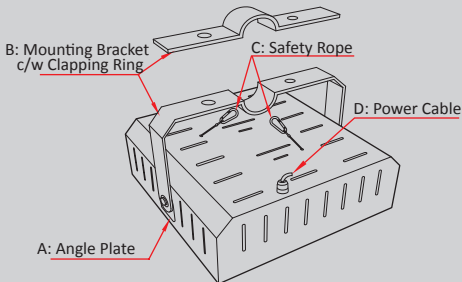

Note: The angle plate allows 360° rotation and 10° per move.

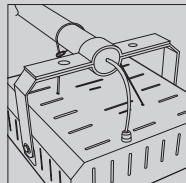
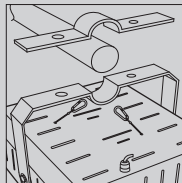



# Wiring

1. Connect supply wires to luminaire wire leads per the wiring diagram using methods that comply with all applicable codes.
2. Turn power on.

## A. American Standard Power Cable

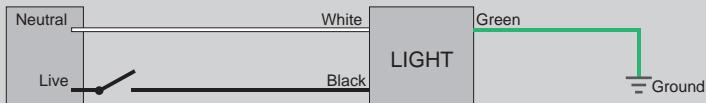

## B. European Standard Power Cable

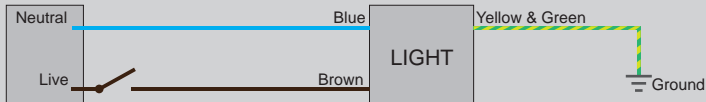

## C. Australian Standard Power Cable

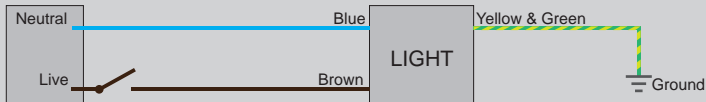

# Specification

AC Voltage	100~277V/200~480V	Power Frequency	50/60Hz
Working Temp.	-30~+55°C	Working Humidity	15%~90%RH
Storing Temp.	-40~+70°C	IP Rating	IP65/IP67
Fixture Size & Net Weight			
300W Light Dimensions	L560xW375xH180mm	300W Light Net Weight	16.8kg±0.4kg
450W Light Dimensions	L560xW560xH180mm	450W Light Net Weight	21.7kg±0.5kg

All statements, technical information and recommendations contained herein are based on information and tests we believe to be reliable. The accuracy or completeness thereof is not guaranteed.