

LED ET5-2140H

Lamp Class: T5 Hybrid (A+B)



Product Description

A smart energy-saving alternative to traditional fluorescent lighting, the Euri Lighting ET5-2140H outputs high lumens for low watts. With hybrid technology, this 4-foot LED tube makes for uncomplicated installation with or without a ballast. Shatterproof glass and built to last 50,000 hours, Euri Lighting's ET5-2140H reduces energy and maintenance worries with every use. See Euri Lighting ET5-2150H for Cool White (5000K).



LED Hybrid Tube

Hybrid technology reduces maintenance expenses and allows adaptable installation methods whether a ballast is present or not



Estimated Energy Cost: \$2.89-3.19 per year

*Note: Design, features and specifications subject to change without notice. Some features may not be available on all models. Please visit www.eurilighting.com or call 1-888-743-5766 for more information.

Specifications

	Input Power	Lumen Output	Luminous Efficacy	Estimated Yearly Cost	Input Voltage
Plug & Play (Type A)	26.5 W	3200 lm	120.7 lm/W	\$3.19	AC120-277 V
Bypass (Type B)	24 W	3200 lm	133 lm/W	\$2.89	

CCT	CRI	Beam Angle	Power Factor	Input Current	Base/Cap	Lamp Lifespan
4000 K	83	120°	0.9	0.22 A	G5	50,000 Hrs.

Product Features

- Energy Efficient
- Damp Rated
- Shatterproof Glass
- Double Ended

Product Dimensions

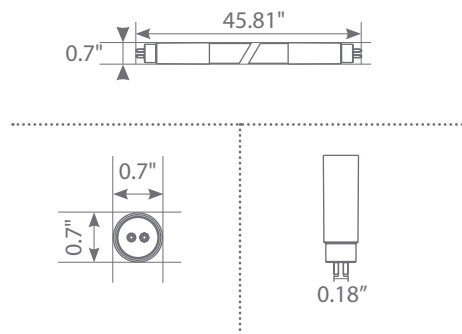

Lamp Holder Compatibility

