

Features & Specifications

PLT & AREA LIGHTS

INTENDED USE – LED area lights are all-purpose site lighting fixtures that can be used for parking lots, car dealerships, outdoor stadiums, pathways, and parks. These LED fixtures will yield a significant reduction in energy consumption compared to standard HID systems and virtually eliminate ongoing maintenance expenses with a long-lasting lifespan. Designed for outdoor applications, the LED area light fixtures will provide reduced offsite visibility as well as effective security lighting.

CONSTRUCTION – Heavy-duty die cast aluminum housing with bronze polyester powder paint for corrosion-free durability. Resistant to rough vibrations and external impacts. Acrylic lens protects the LEDs and provides even light distribution. Housing is sealed with a silicone gasket, protecting against moisture and environmental contaminants (IP68 rated). Modular LED bricks wired in parallel for ease of maintenance.

OPTICS – High-performance Lumileds LEDs and Mean Well driver maintain a 26,400 Lumen output at 5000K. ≥ 70 CRI.

Type III light distribution is intended for perimeter lighting of parking lots and along the edges of an open area as well as large roadways and parking lot aisles. It casts more light forward so that it can be used to light roads and pathways from the side of the road rather than being installed in the median.

LED area lights are designed to have a more directional beam angle than metal halide and high pressure sodium fixtures so no light is lost within or above the fixture. These LED fixtures also do not lose Lumens in the same way as a HID fixture, meaning the brightness stays consistent longer and needs to be replaced far less frequently.

ELECTRICAL – Input voltage of 120-277 VAC, 50/60Hz. Consider adding a surge protector to protect your fixtures from power surges in your electrical system as an added insurance policy to your investment.

INSTALLATION – A slipfitter mounting bracket for round pole mounting applications makes retrofit installation simple, resulting in reduced installation time and additional labor savings. Slipfitter mounts provide more flexibility and control over installation and light distribution by offering a broader range of angles than a stationary arm.

LISTINGS – UL Certified to safety standards for wet location. Rated for -40°C to 45°C ambient temperature. IP-68 Rated.

WARRANTY – 5-year warranty. PLT products that are damaged or defective will be repaired or replaced at PLT's choosing for a period of 5 years. Contact 1-800-624-4488 for more information.

ADD-ONS – Pair with timers, photocells, and motion sensors for hassle free bright night time lighting and energy savings during the day. If pairing with a photocell, it must be LED compatible in order to operate properly. If using a conventional photocell, be sure to replace it with one rated for use with LEDs. While conventional light sensors will still work with LED fixtures at first, they will burn out prematurely. The same is true for motion sensors.

If you live in the northern hemisphere, your photocells should face north whenever possible. North-facing light sensors allow for the most balanced on/off schedule based on the arc of the sun. If pointed west, it will turn on and off late and vice versa for east-facing light sensors. Photocells facing the south will be exposed to the most direct sunlight which can burn out the components and cause premature failure. If you want your lights to come on early or late, we recommend pointing the light sensor northeast or northwest, respectfully. The opposite is true south of the equator.

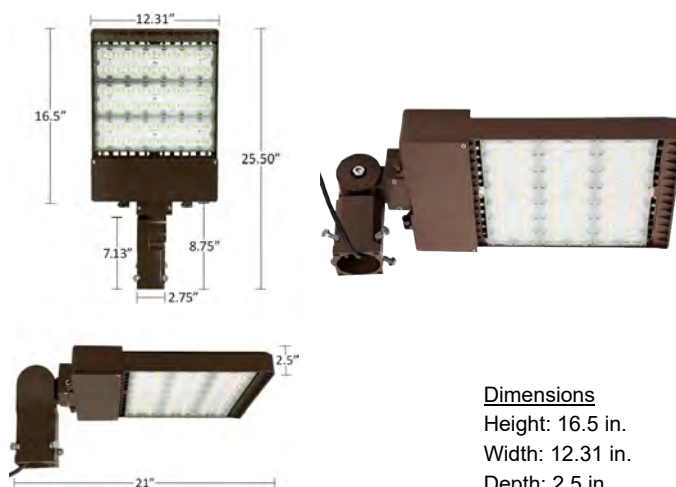

Dimensions
Height: 16.5 in.
Width: 12.31 in.
Depth: 2.5 in.

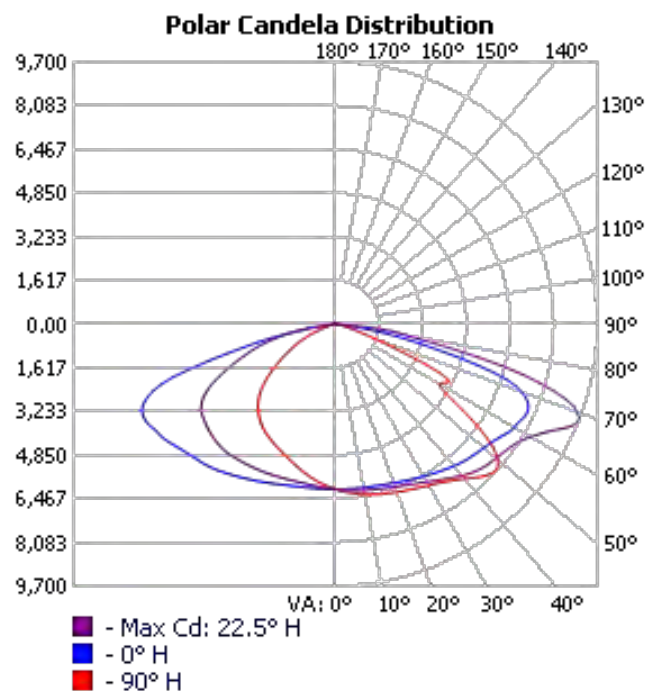

SKU #	Kelvin	Lumens	Wattage	CRI	Voltage	DLC?	Mounting	Life Hours	Warranty
LEDF-10117	5000	26,400	220	70	120-277	NO	SLIP FITTER	50,000	5 YEAR

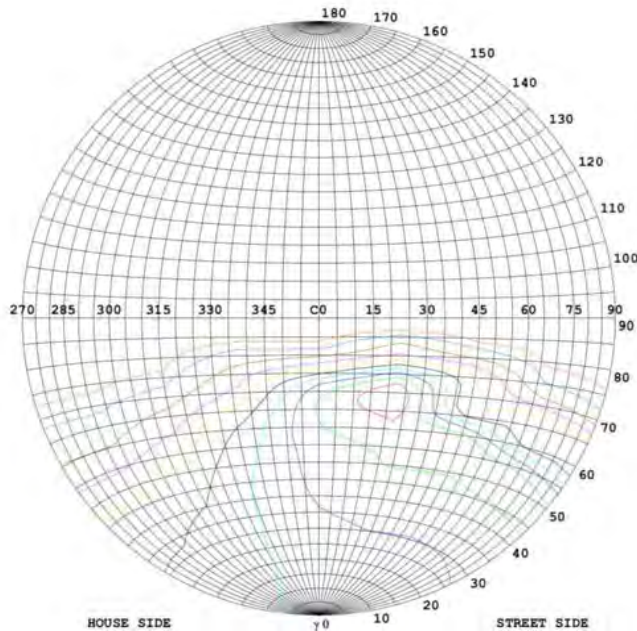
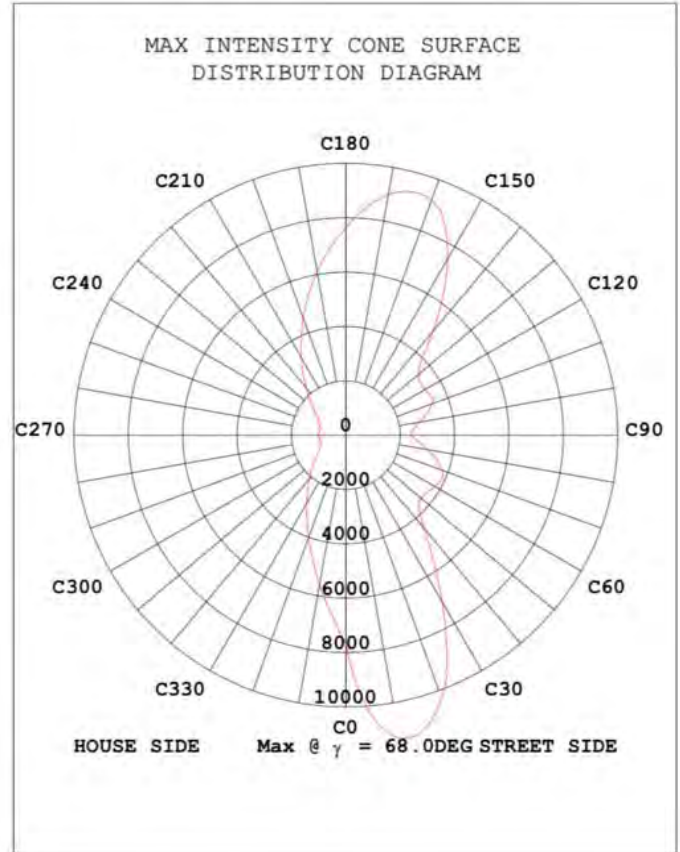
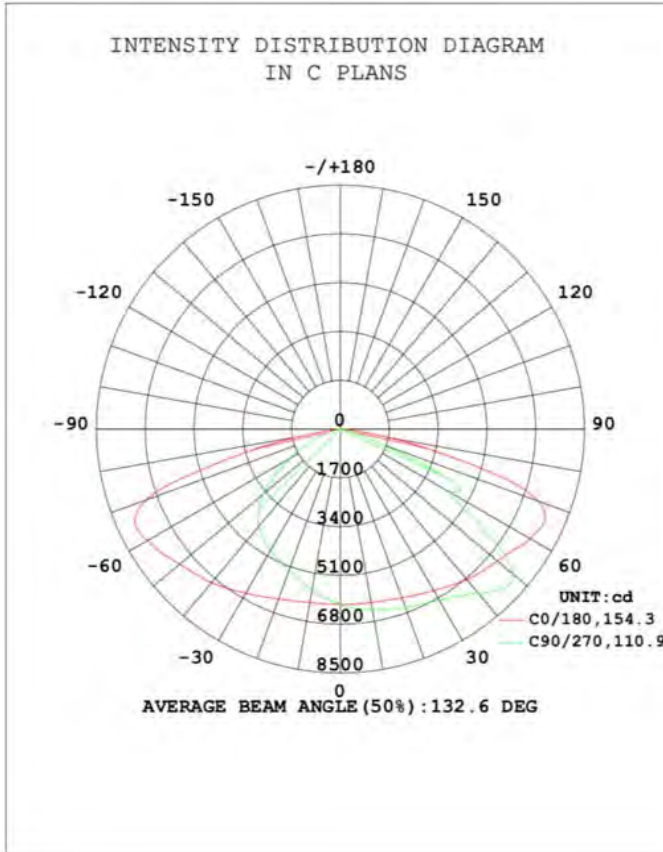

Classification:

IES: Type III - Medium
 CIE: Average - Intermediate
 IES: Semi cut-off
 CIE: Non-cut-off
 Max. At 80: 117.1 cd/klm
 Max. At 90: 0.5210 cd/klm
 Max. 80-90: 117.1 cd/klm

ISOCANDELA DIAGRAM	
UNIT	cd
Imax=100%	9666
90%	8700
80%	7733
70%	6766
60%	5800
50%	4833
40%	3866
30%	2900
20%	1933
10%	967
5%	483

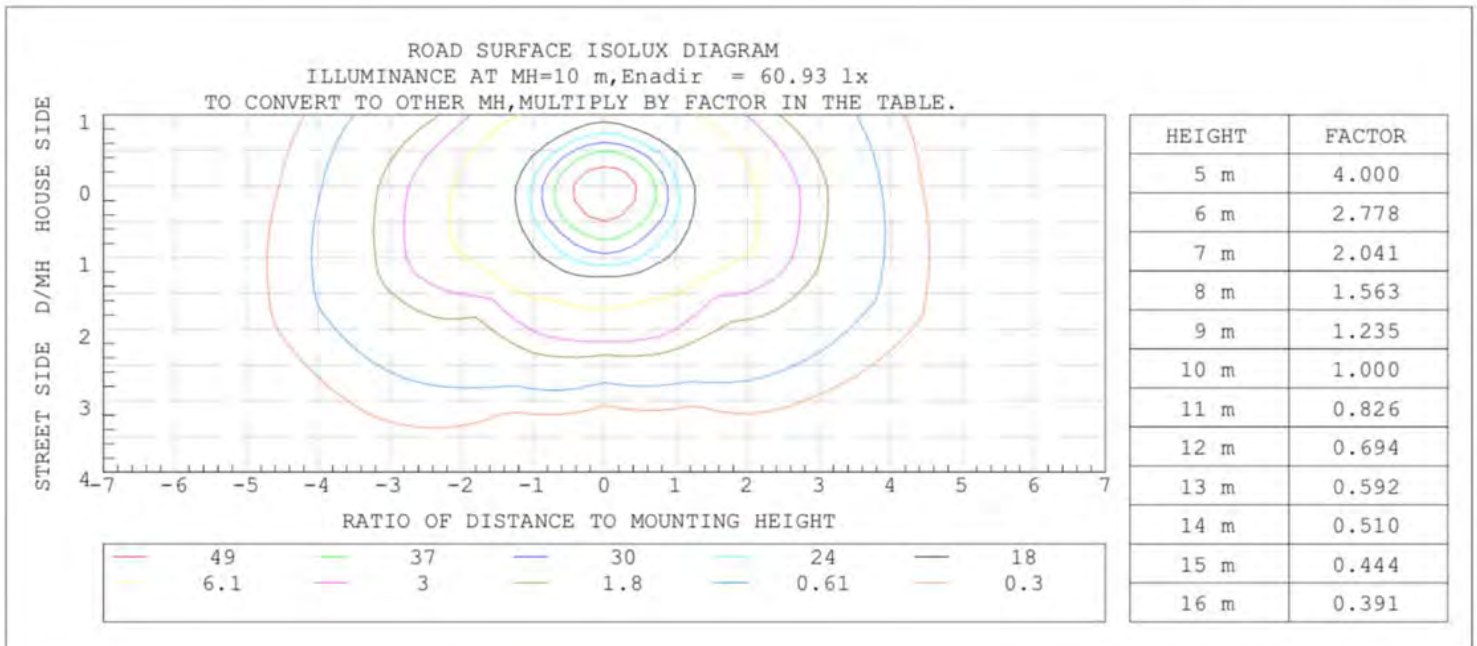
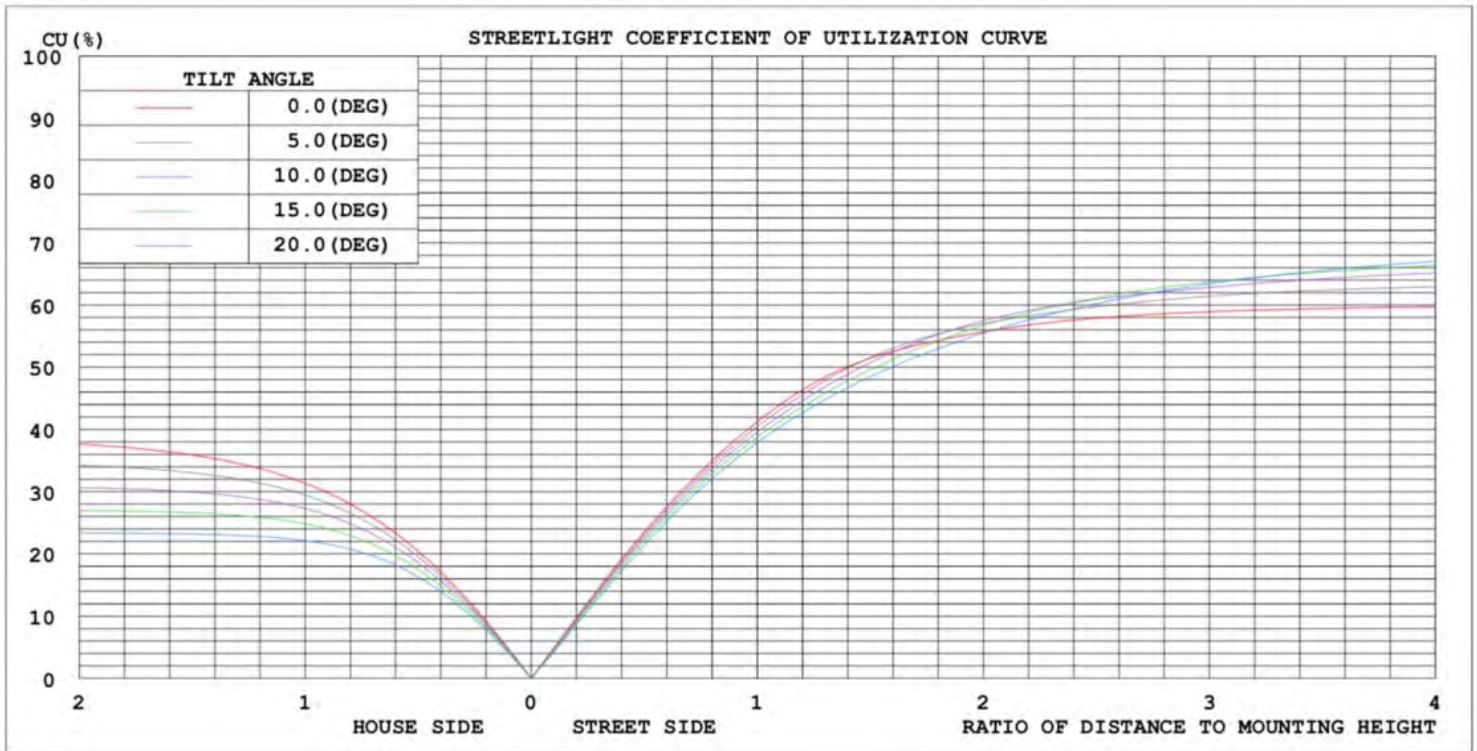

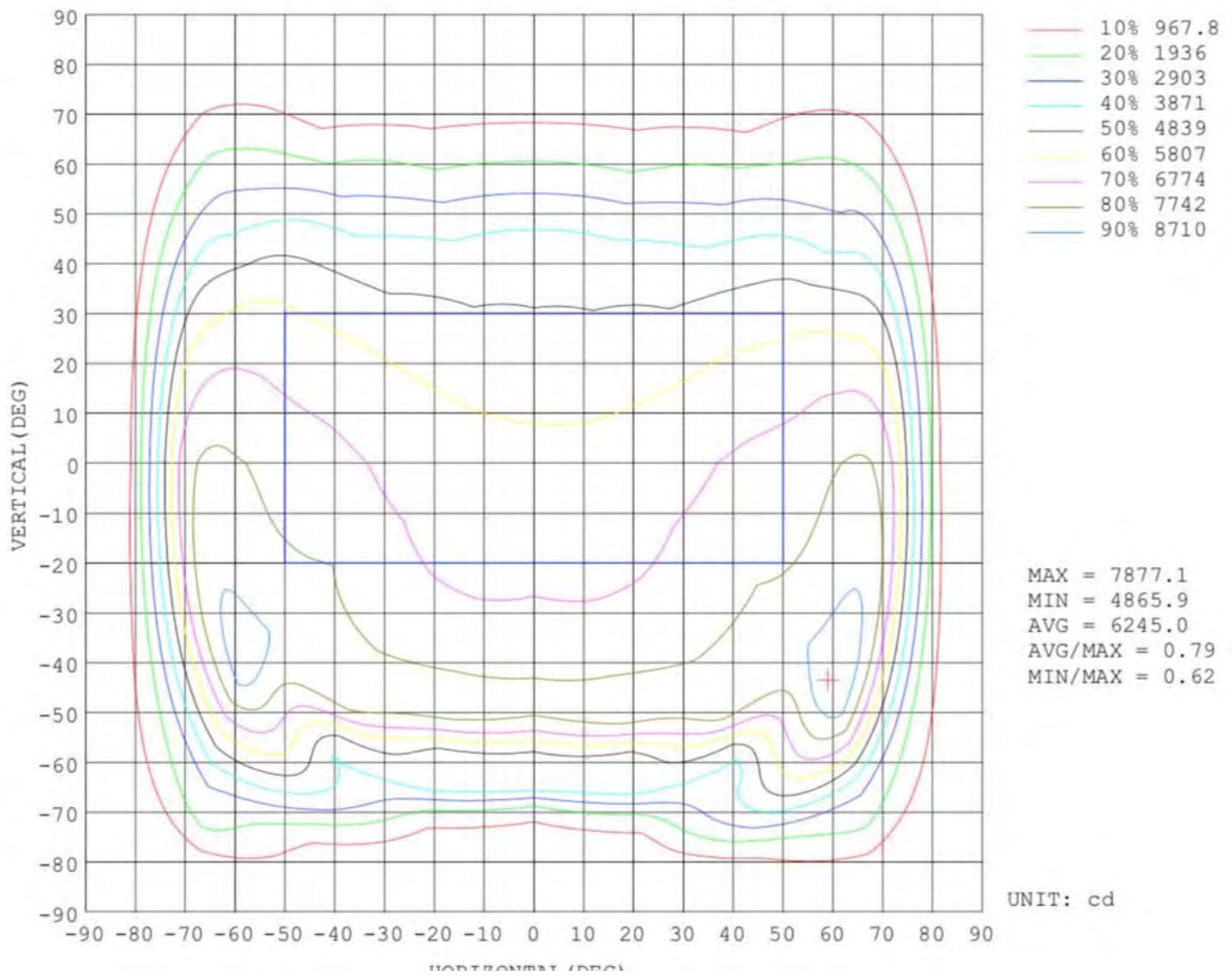

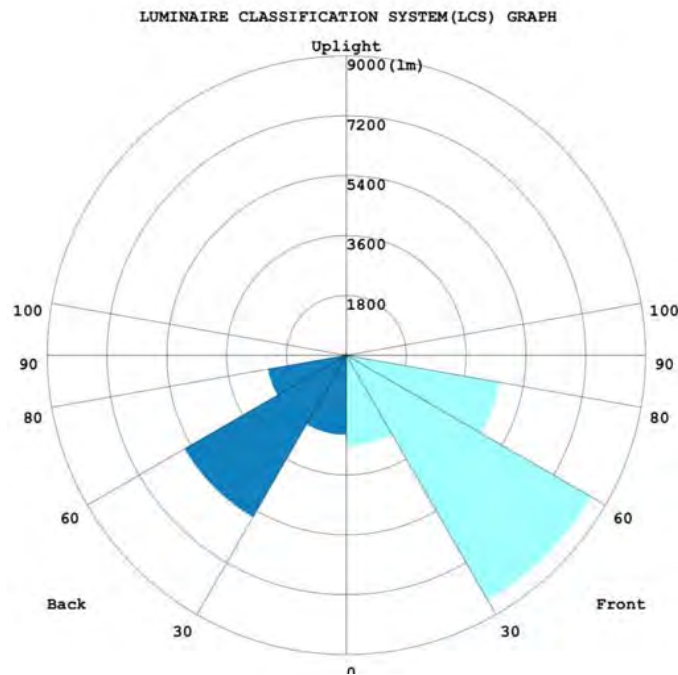
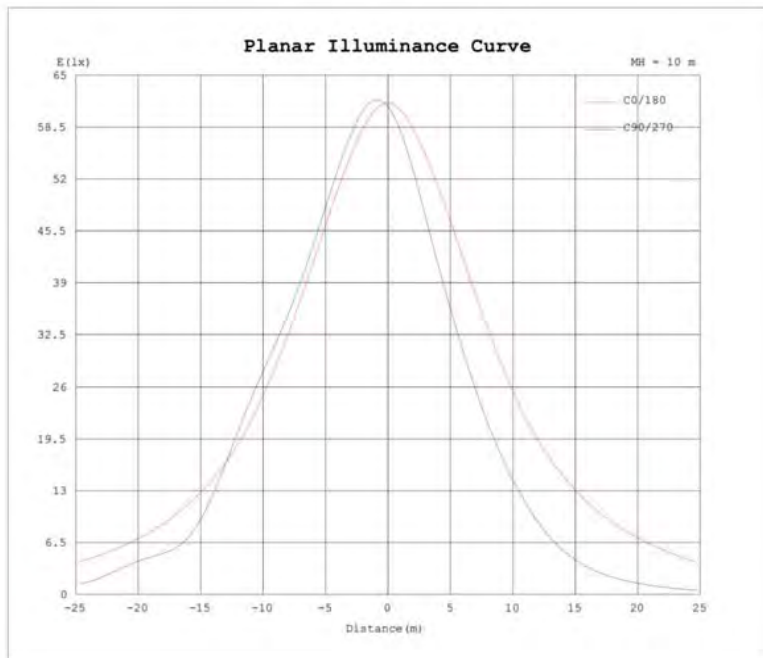

Improved LED Modules design

- ** No soldering on production line, assembly speed fastened
- ** Plug-in pin for LED modules, easy assembly & replace in future
- ** Temp of LED Board: 60° C (Ambient Temp=25° C)

LED Lens

- ** Type III, Type V, 90x120°
- ** With small pins on the back side for locating the connection hole on the LED board, to avoid wrong direction assembly.

Waterproof apron for LED modules.

Extruded aluminum heat sink, coefficient of heat transfer up to 221

- ** Heat dissipation trippled than before
- ** Lighter weight
- ** LED Modules can directly connected to heat sink, the temp difference between is only 2-3° C
- ** Temp for heat sink= 60° C (Ambient Temp=25° C)

Die-casting aluminum power pack

- ** Reliable structure
- ** Better for IP rating
- ** Isolates the heat generated from the LED Modules to power supply
- ** Simple but reliable way to fix driver, easy to replace in future.

Patent, Unique slide-in Mount installation

- ** Ideal for inventory
- ** Ideal for SKD
- ** Easy installation
- ** Save labor cost
- ** Will not affect light, power & IP rating when changing the mount.

Clamshell power supply cover
Much more convenient for installation, save labor cost.

STANDARD MOUNT-SLIP FITTER



- ◆ Installation angle: 0-90°
- ◆ Max Pole size: 2-3/8"
- ◆ Each rotation is 4°
- ◆ Max Load Weight: 110lbs
- ◆ Installation: for round pole

