

# PHILIPS ADVANCE

## LED Driver

### Xitanium

180W 0.1-1.25A 0-10V Dimming  
with SimpleSet  
XI180C125V200BSF1



Philips Advance Xitanium outdoor LED drivers with SimpleSet technology are designed to give OEMs ultimate flexibility. With wide operating windows and simple programming, the drivers make it easy for luminaire manufacturers to design luminaires of different sizes and lumen levels for outdoor applications.

### Specifications

| Input Voltage (Vac) | Output Power (W) | Output Voltage (V) | Output Current (A) | Efficiency@ Max Load and 75°C Case | Max Case Temp. (°C)      | Input Current (A) | Max. Input Power (W) | THD @ Max Load (%) | Power Factor @ Max Load | Surge Protection (Combi-Wave, KV) | Envir. Protection Rating  |
|---------------------|------------------|--------------------|--------------------|------------------------------------|--------------------------|-------------------|----------------------|--------------------|-------------------------|-----------------------------------|---------------------------|
| 120                 | 180              | 70-200             | 0.1 - 1.25         | 91.5                               | Life - 85°C<br>UL - 90°C | 1.87              | 198                  | <10%               | >0.95                   | 6                                 | UL damp & dry and Type HL |
| 277                 |                  |                    |                    | 94                                 |                          | 0.72              |                      | <15%               |                         |                                   |                           |

### Enclosure

|                 | In. (mm)     |
|-----------------|--------------|
| Case Length     | 8.31 (211)   |
| Case Width      | 2.31 (58.6)  |
| Case Height     | 1.48 (37.6)  |
| Mounting Length | 8.91 (226.3) |
| Overall Length  | 9.47 (240.5) |

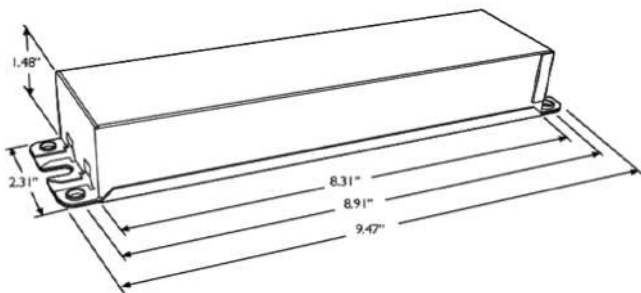

### Wiring Diagram

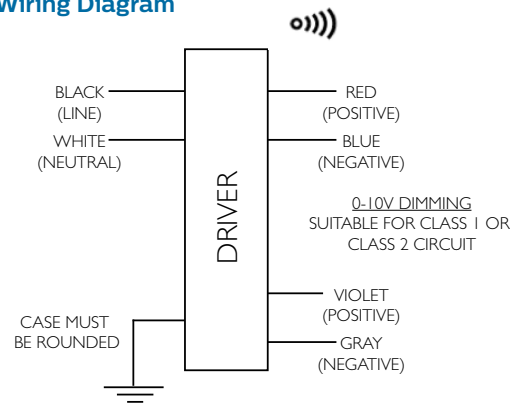

| Dimming                           | Dimming Range (with specified dimmers) | Minimum Output Current (A) |
|-----------------------------------|--|----------------------------|
| 0-10V Analog Class 1 and 2 Wiring | 10% ~ 100%                             | 0.07                       |

# Xitanium 180W 0.1-1.25A 0-10V Dimming with SimpleSet

## Features

- 50,000+ hour lifetime<sup>1</sup>
- Programmable output current through SimpleSet
- Large operating window
- 6kV combi-wave surge rating to comply with ANSI C82.77-5 CAT C low

## Benefits

- Enables long life luminaire designs
- Fast and simple way of programming
- Enables fixture designs with wide variety of loads and adjustable current options
- No external surge protection required to pass C82.77-5 CAT C low

## Application

- Area
- Roadway
- Parking garages
- Floodlights

## Electrical Specifications

All the specifications are typical and at 25°C Tcase unless specified otherwise.

## Product Data

| Order Information  |   |
|--|---|
| Full Product Code  | XI180C125V200BSF1M (Mid-Pack, 10pcs/Box)  |
| Line Frequency   | 50/60Hz   |
| Min. Mains Voltage Operational                             | 108 Vac   |
| Max. Mains Voltage Operational                             | 305 Vac   |
| Output Information   |   |
| Maximum Open Circuit Voltage                               | 270Vdc  |
| Output Current Ripple (ripple = peak to average / average) | 15% max @ max lout<br>(Low frequency ripple (≤120Hz) content <5%)   |
| Output Current Tolerance (in performance window)           | <5%   |
| Protections  | Short Circuit, Open Circuit Protection for LED + and LED – and Temperature Foldback                           |
| Features   |   |
| 0-10V Dimming  | 150µA (±3%) source current from driver. See dim curve for detail.   |
| AOC (Adjustable Output Current)                            | 0.1A-1.25A via SimpleSet (Factory Default at 1.05A)   |
| Additional SimpleSet Configurable Features                 | Adjustable Min Dim level,<br>Adjustable Lumen Output,<br>Adjustable Lumen Output Min,<br>OEM Write Protection |
| Environment & Approbation                                  |   |
| Operating Ambient Temp. Range                              | -40°C to +55°C  |
| Max Case Temperature (Tcase)                               | 85°C for Life & 90°C for UL Safety  |
| Agency Approbations  | UL 8750, CSA 250.13, UL Listed, ETL Class P   |
| Electromagnetic Compliance                                 | FCC Title 47 Part 15 Class A  |
| Audible Noise  | <24dB Class A   |
| Weight   | 2.1 Lbs / 0.95 kgs  |

1. Philips Advance Xitanium LED drivers are manufactured to engineering standards correlating to a designed and average life expectancy of 50,000 hours of operation at maximum rated case temperature. Minimum 90% survivals based on MTTF modeling.

# Xitanium 180W 0.1-1.25A 0-10V Dimming with SimpleSet

## Electrical Specifications

All the specifications are typical and at 25°C Tcase unless specified otherwise.

## 0-10V Dimming Curve

Dimming source current from the driver: 150µA (@ 0<Vdim<8V)

Minimum dim level: 10% of Iout setting as default

Maximum output voltage on the dimming wires: 12V

## Approved Dimmer List

| Manufacturer | Manufacturer Part Number  |
|--------------|---|
| Lutron       | Visit <a href="http://www.lutron.com/advance">www.lutron.com/advance</a> for a list of dimmers (Mark VII) that will work with this driver |
| Leviton      | IllumaTech IP7 series   |
| Philips      | Sunrise - SR1200ZTUNV   |

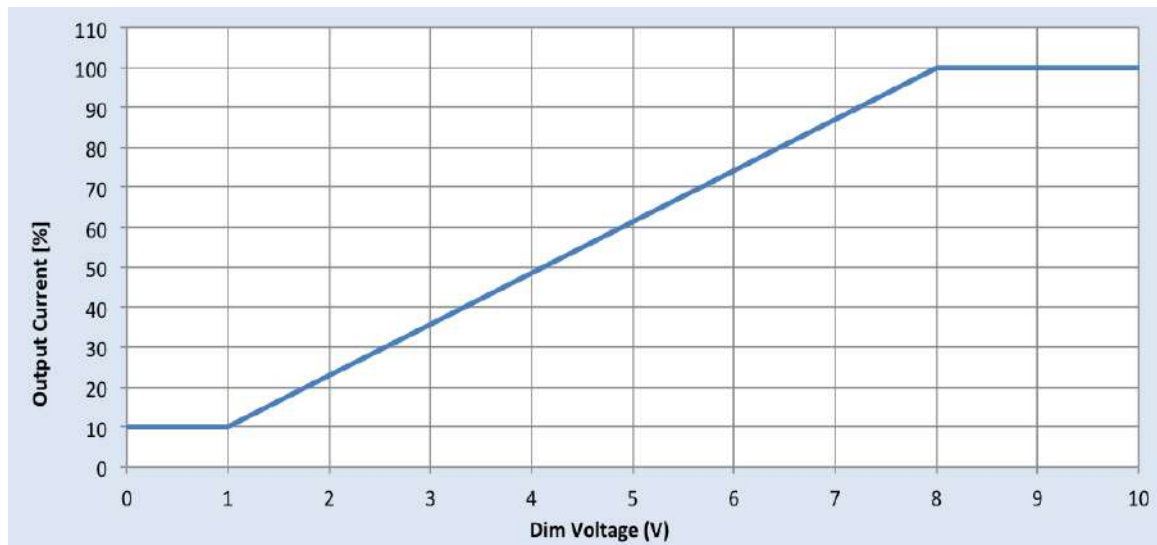

# Xitanium 180W 0.1-1.25A 0-10V Dimming with SimpleSet

## Electrical Specifications

All the specifications are typical and at 25°C Tcase unless specified otherwise.

## Driver Output Window

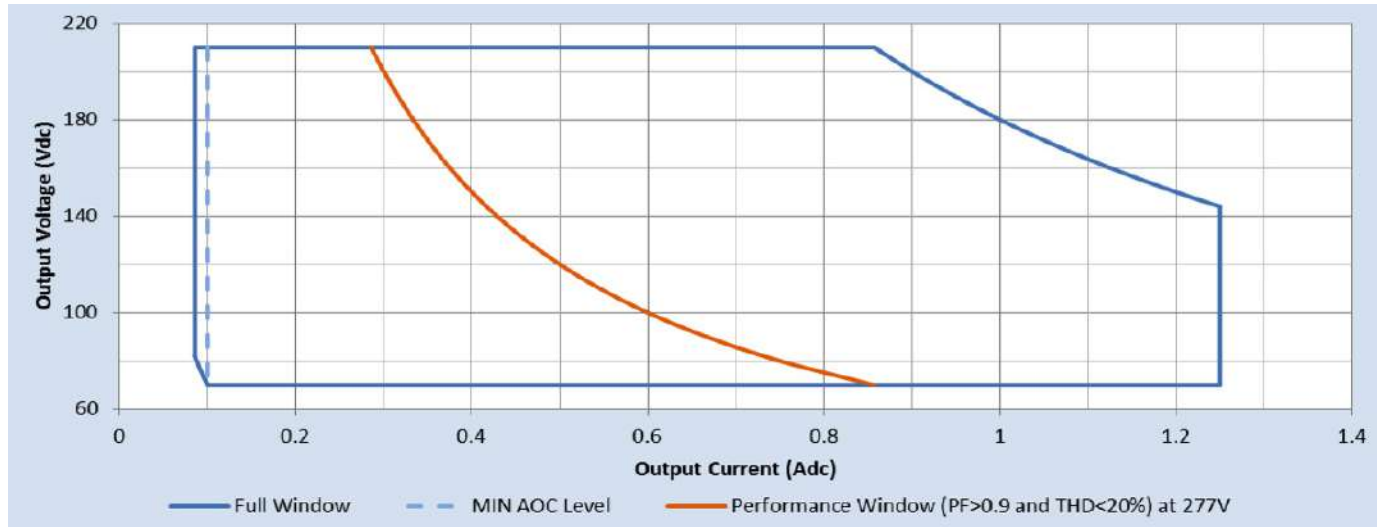

## Notes

1. Factory default output current is 1.05A.
2. To get a 100% to 10% dimming range, the output current setting through AOC should be  $\geq 700\text{mA}$ .
3. Factory default minimum dimming level is 10%. This can be adjusted between 10% and 100% using Philips MultiOne.

# Xtanium 180W 0.1-1.25A 0-10V Dimming with SimpleSet

## Electrical Specifications

All the specifications are typical and at 25°C Tcase unless specified otherwise.

### Output Current Vs. Driver Case Temperature

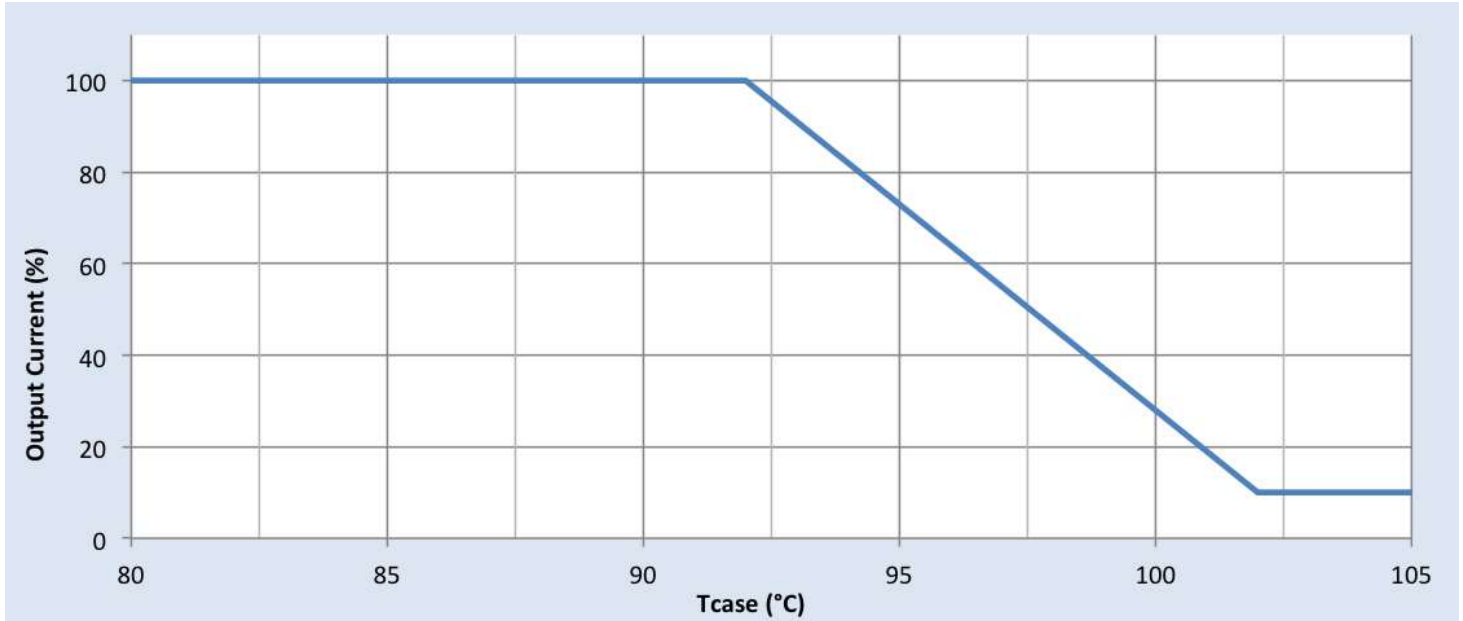

### Note

There is  $\pm 5^\circ\text{C}$  tolerance on the driver case temperature.

### Driver Lifetime vs. Driver Case Temperature

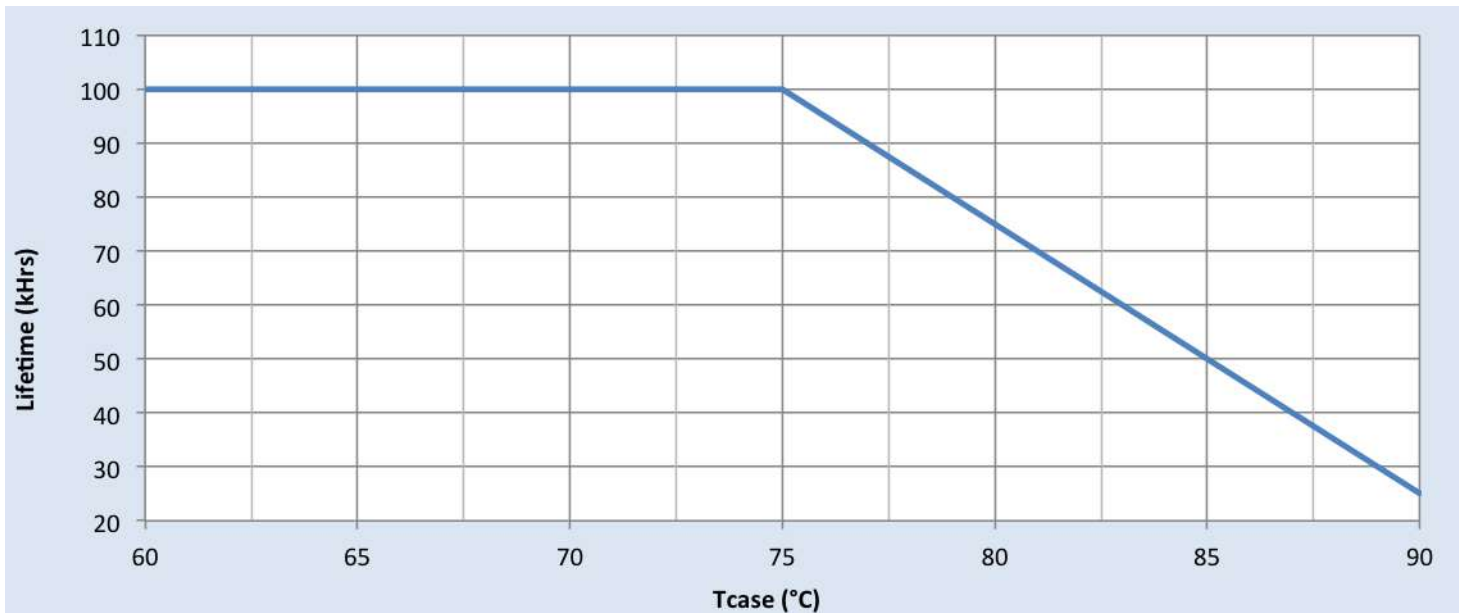

# Xtanium 180W 0.1-1.25A 0-10V Dimming with SimpleSet

## Performance Characteristics

Based on measurements on a typical sample at 70°C case. The accuracy of the measurements is within the tolerance of the measurement instruments.

### Efficiency Vs. Output Voltage at 120Vac

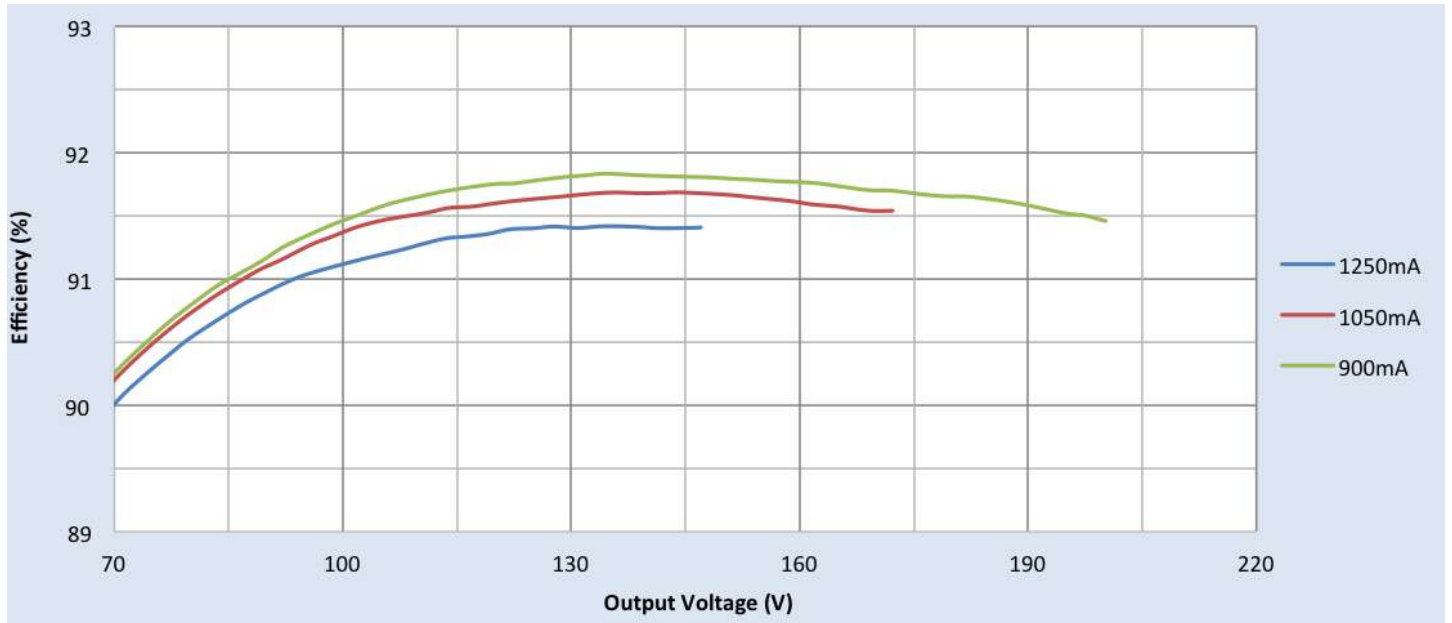

### Efficiency Vs. Output Voltage at 277Vac



# Xitanium 180W 0.1-1.25A 0-10V Dimming with SimpleSet

## Performance Characteristics

Based on measurements on a typical sample at 70°C case. The accuracy of the measurements is within the tolerance of the measurement instruments.

### Power Factor Vs. Output Power

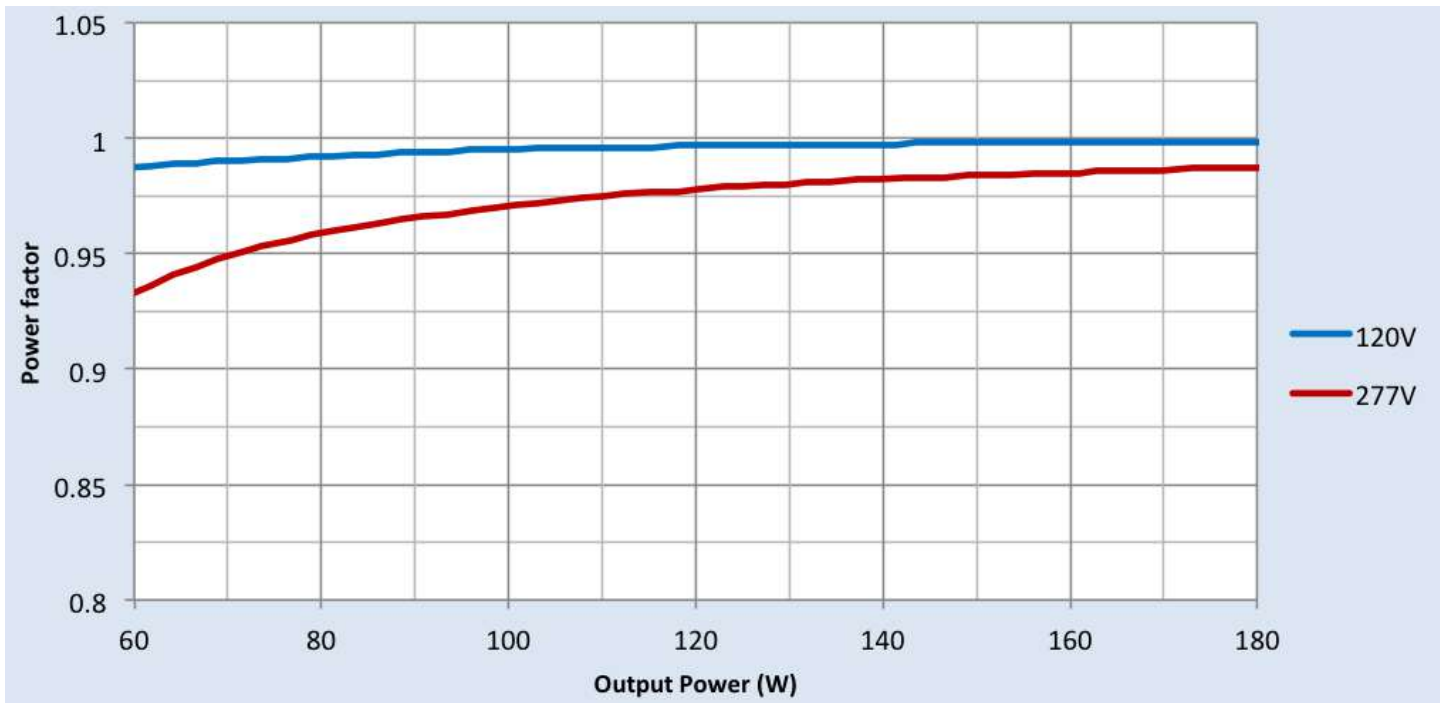

### Total Harmonic Distortion (THD) Vs. Output Power

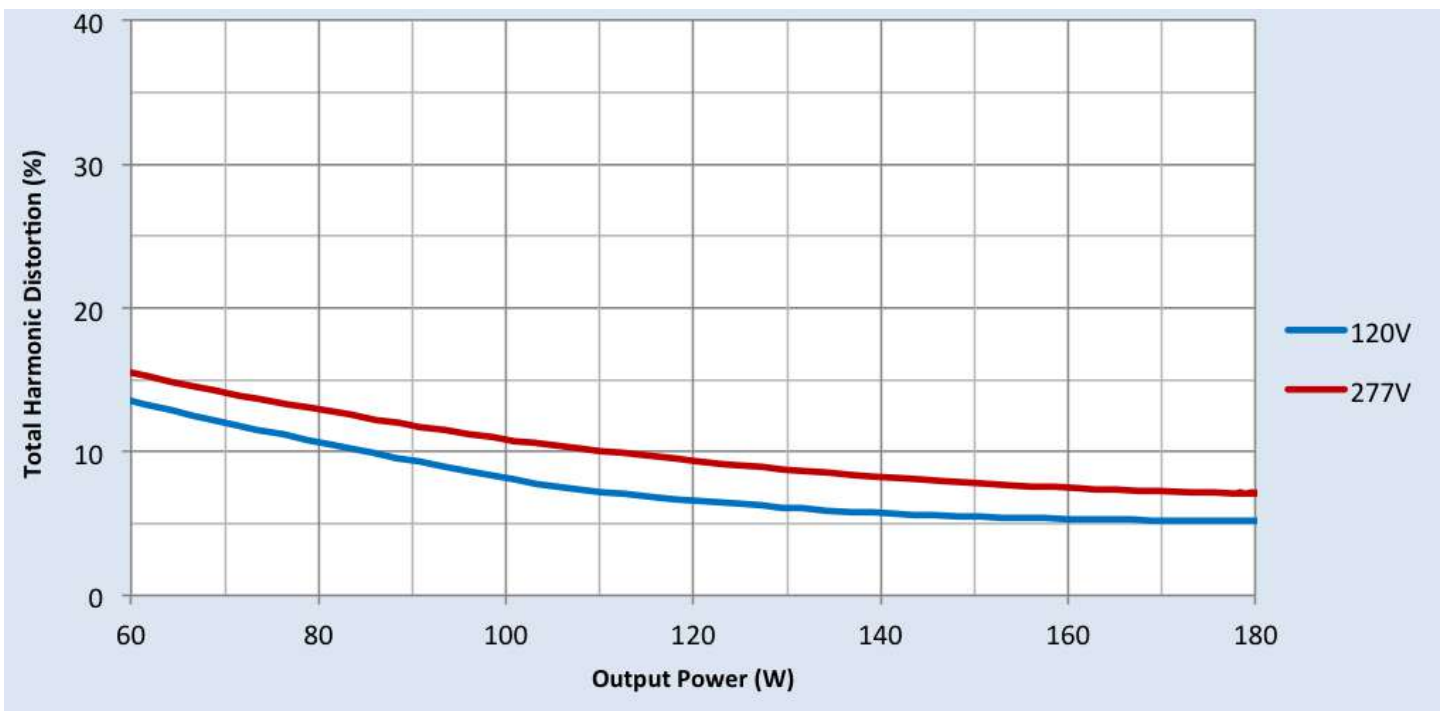

# Xitanium 180W 0.1-1.25A 0-10V Dimming with SimpleSet

## Inrush Current Info

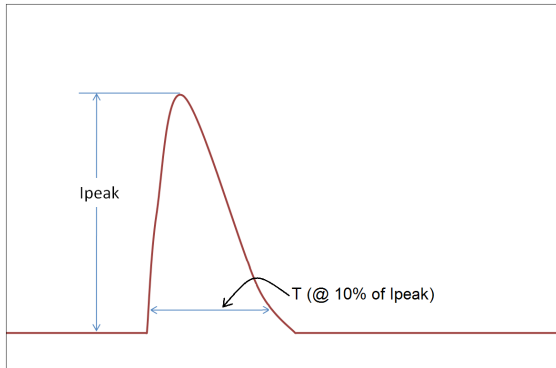

| Vin      | Ipeak | T (@ 10% of Ipeak) |
|----------|-------|--------------------|
| 120 Vrms | 53A   | 270µS              |
| 277 Vrms | 138A  | 256µS              |

Inrush current is measured at peak of the corresponding line voltage. Source impedance per NEMA 410.

## Lightning Surge Info

| ANSI Surge Type                    | Differential Mode (L-N) | Common Mode (L-G, N-G, L&N-G) |
|------------------------------------|-------------------------|-------------------------------|
| 1.2/50µs Combination Wave (w/t 2Ω) | 6kV                     | 6kV                           |

## Isolation

| Isolation | Input   | Output  | 0-10V | Enclosure |
|-----------|---------|---------|-------|-----------|
| Input     | NA      | 2xU+1kV | 2.5kV | 2xU+1kV   |
| Output    | 2xU+1kV | NA      | 2.5kV | 2xU+1kV   |
| 0-10V     | 2.5kV   | 2.5kV   | NA    | 2.5kV     |
| Enclosure | 2xU+1kV | 2xU+1kV | 2.5kV | NA        |

U = Max input voltage

## UL Conditions of Acceptability

Please contact your Philips representative for a copy of the latest UL Conditions of Acceptability (COA).

© 2016 Philips Lighting Holding B.V. All rights reserved.  
 Philips reserves the right to make changes in specifications and/or to discontinue any product at any time without notice or obligation and will not be liable for any consequences resulting from the use of this publication.  
[philips.com/leddrivers](http://philips.com/leddrivers)

