



# REFINE PAR FAMILY

## FEATURES

- Suitable to replace 50W, 75W, 120W halogen lamps
- Proprietary designed optic maximizes output, efficacy, color fidelity, and visual comfort
- High CRI and R values (R9 85, R13 95) deliver richer reds and healthier skin tones
- Smooth dimming with existing dimmers\*
- Compact size 1:1 halogen form factor
- Spot, Narrow, Flood beam angles
- Suitable for use in totally enclosed fixtures
- Suitable for use in damp locations
- Fixture operating temperature: -4°F to 95°F (-20°C to 35°C)  
Lamp ambient temperature: -4°F to 113°F (-20°C to 45°C)
- Rated Lifetime (L70): 50,000hrs
- 5 year limited warranty



## SPECIFICATIONS

Product	Model	Equiv.	Wattage (W)	CCT	Lumens	Efficacy (LPW)	Input Voltage	Beam Angle	CBCP (cd)	CRI	Dim.*	Power Factor	Base	Fixture Rating	TRUE CHROMA	ES / T20
34890	6.5PAR20DIM/927SP15	50W	6.5	2700K	520	80	120V	15°	5,000	95	Yes	0.9	E26	Enclosed		√/N.A.
34891	6.5PAR20DIM/927NF25	50W	6.5	2700K	560	86	120V	25°	1,800	95	Yes	0.9	E26	Enclosed		√/√
34892	6.5PAR20DIM/927FL40	50W	6.5	2700K	560	86	120V	40°	1,100	95	Yes	0.9	E26	Enclosed		√/√
34893	6.5PAR20DIM/930SP15	50W	6.5	3000K	550	85	120V	15°	5,300	95	Yes	0.9	E26	Enclosed		√/N.A.
34894	6.5PAR20DIM/930NF25	50W	6.5	3000K	580	89	120V	25°	1,900	95	Yes	0.9	E26	Enclosed		√/√
34895	6.5PAR20DIM/930FL40	50W	6.5	3000K	580	89	120V	40°	1,200	95	Yes	0.9	E26	Enclosed		√/√
34896	6.5PAR20DIM/940FL40	50W	6.5	4000K	600	92	120V	40°	1,300	95	Yes	0.9	E26	Enclosed	NO	√/√
<b>34897</b>	<b>6.5PAR20DIM/930FL40/B</b>	<b>50W</b>	<b>6.5</b>	<b>3000K</b>	<b>580</b>	<b>89</b>	<b>120V</b>	<b>40°</b>	<b>1,200</b>	<b>95</b>	<b>Yes</b>	<b>0.9</b>	<b>E26</b>	<b>Enclosed</b>		<b>√/√</b>
34898	11PAR30DIM/927SP15	75W	11	2700K	950	86	120V	15°	10,000	95	Yes	0.9	E26	Enclosed		√/√
34899	11PAR30DIM/927NF25	75W	11	2700K	950	86	120V	25°	4,500	95	Yes	0.9	E26	Enclosed		√/√
34900	11PAR30DIM/927FL40	75W	11	2700K	950	86	120V	40°	1,700	95	Yes	0.9	E26	Enclosed		√/√
34901	11PAR30DIM/930SP15	75W	11	3000K	990	90	120V	15°	10,600	95	Yes	0.9	E26	Enclosed		√/√
34902	11PAR30DIM/930NF25	75W	11	3000K	990	90	120V	25°	4,700	95	Yes	0.9	E26	Enclosed		√/√
34903	11PAR30DIM/930FL40	75W	11	3000K	990	90	120V	40°	1,750	95	Yes	0.9	E26	Enclosed		√/√
34904	11PAR30DIM/940FL40	75W	11	4000K	1,030	94	120V	40°	1,850	95	Yes	0.9	E26	Enclosed	NO	√/√
34905	11PAR30DIM/930FL40/B	75W	11	3000K	990	90	120V	40°	1,750	95	Yes	0.9	E26	Enclosed		√/√
34906	11PAR30SDIM/927SP15	75W	11	2700K	950	86	120V	15°	10,000	95	Yes	0.9	E26	Enclosed		√/√
34907	11PAR30SDIM/927NF25	75W	11	2700K	950	86	120V	25°	4,500	95	Yes	0.9	E26	Enclosed		√/√
34908	11PAR30SDIM/927FL40	75W	11	2700K	950	86	120V	40°	1,700	95	Yes	0.9	E26	Enclosed		√/√
34909	11PAR30SDIM/930SP15	75W	11	3000K	990	90	120V	15°	10,600	95	Yes	0.9	E26	Enclosed		√/√
34910	11PAR30SDIM/930NF25	75W	11	3000K	990	90	120V	25°	4,700	95	Yes	0.9	E26	Enclosed		√/√
34911	11PAR30SDIM/930FL40	75W	11	3000K	990	90	120V	40°	1,750	95	Yes	0.9	E26	Enclosed		√/√
34912	11PAR30SDIM/940FL40	75W	11	4000K	1,030	94	120V	40°	1,850	95	Yes	0.9	E26	Enclosed	NO	√/√
34913	11PAR30SDIM/930FL40/B	75W	11	3000K	990	90	120V	40°	1,750	95	Yes	0.9	E26	Enclosed		√/√



# REFINE PAR FAMILY

## SPECIFICATIONS

Product	Model	Equiv.	Wattage (W)	CCT	Lumens	Efficacy (LPW)	Input Voltage	Beam Angle	CBCP (cd)	CRI	Dim.*	Power Factor	Base	Fixture Rating	TRUE CHROMA	ES / T20
34916	15.5PAR38DIM/927SP15	120W	15.5	2700K	1,320	85	120V	15°	14,000	95	Yes	0.9	E26	Enclosed		√/√
34917	15.5PAR38DIM/927NF25	120W	15.5	2700K	1,320	85	120V	25°	6,750	95	Yes	0.9	E26	Enclosed		√/√
34918	15.5PAR38DIM/927FL40	120W	15.5	2700K	1,320	85	120V	40°	2,800	95	Yes	0.9	E26	Enclosed		√/√
34919	15.5PAR38DIM/930SP15	120W	15.5	3000K	1,370	88	120V	15°	14,700	95	Yes	0.9	E26	Enclosed		√/√
34920	15.5PAR38DIM/930NF25	120W	15.5	3000K	1,370	88	120V	25°	7,000	95	Yes	0.9	E26	Enclosed		√/√
34921	15.5PAR38DIM/930FL40	120W	15.5	3000K	1,370	88	120V	40°	2,900	95	Yes	0.9	E26	Enclosed		√/√
34922	15.5PAR38DIM/940FL40	120W	15.5	4000K	1,420	92	120V	40°	3,000	95	Yes	0.9	E26	Enclosed	NO	√/√
34923	15.5PAR38DIM/930NF25/B	120W	15.5	3000K	1,370	88	120V	25°	7,000	95	Yes	0.9	E26	Enclosed		√/√
34924	15.5PAR38DIM/930FL40/B	120W	15.5	3000K	1,370	88	120V	40°	2,900	95	Yes	0.9	E26	Enclosed		√/√
34925	15.5PAR38DIM/930FL40/GU24	120W	15.5	3000K	1,370	88	120V	40°	2,900	95	Yes	0.9	GU24	Enclosed		√/√
34914	11PAR30/930FL40/277V	75W	11	3000K	990	90	120-277V	40°	1,750	95	No	0.9	E26	Enclosed		√/√
34915	11PAR30/940FL40/277V	75W	11	4000K	1,030	94	120-277V	40°	1,850	95	No	0.9	E26	Enclosed	NO	√/√
34926	15.5PAR38/930FL40/277V	120W	15.5	3000K	1,370	88	120-277V	40°	2,900	95	No	0.9	E26	Enclosed		√/√
34927	15.5PAR38/940FL40/277V	120W	15.5	4000K	1,420	92	120-277V	40°	3,000	95	No	0.9	E26	Enclosed	NO	√/√

\*This lamp might not be compatible with all dimmers. Please see dimmer compatibility sheet.

## DIMENSIONS & WEIGHT

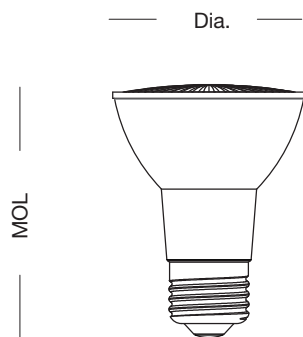

Model	Base	MOL	Dia.	Weight
6.5PAR20DIM/927SP15	E26	3-1/4"	2-1/2"	0.18lb
6.5PAR20DIM/927NF25	E26	3-1/4"	2-1/2"	0.18lb
6.5PAR20DIM/927FL40	E26	3-1/4"	2-1/2"	0.18lb
6.5PAR20DIM/930SP15	E26	3-1/4"	2-1/2"	0.18lb
6.5PAR20DIM/930NF25	E26	3-1/4"	2-1/2"	0.18lb
6.5PAR20DIM/930FL40	E26	3-1/4"	2-1/2"	0.18lb
6.5PAR20DIM/940FL40	E26	3-1/4"	2-1/2"	0.18lb
<b>6.5PAR20DIM/930FL40/B</b>	<b>E26</b>	<b>3-1/4"</b>	<b>2-1/2"</b>	<b>0.18lb</b>



# REFINE PAR FAMILY

## DIMENSIONS & WEIGHT

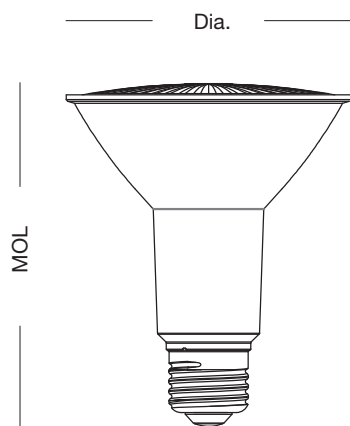

Model	Base	MOL	Dia.	Weight
11PAR30DIM/927SP15	E26	4-7/16"	3-11/16"	0.31lb
11PAR30DIM/927NF25	E26	4-7/16"	3-11/16"	0.31lb
11PAR30DIM/927FL40	E26	4-7/16"	3-11/16"	0.31lb
11PAR30DIM/930SP15	E26	4-7/16"	3-11/16"	0.31lb
11PAR30DIM/930NF25	E26	4-7/16"	3-11/16"	0.31lb
11PAR30DIM/930FL40	E26	4-7/16"	3-11/16"	0.31lb
11PAR30DIM/940FL40	E26	4-7/16"	3-11/16"	0.31lb
11PAR30DIM/930FL40/B	E26	4-7/16"	3-11/16"	0.31lb
11PAR30/930FL40/277V	E26	4-7/16"	3-11/16"	0.33lb
11PAR30/940FL40/277V	E26	4-7/16"	3-11/16"	0.33lb

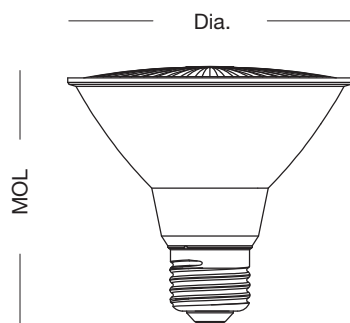

Model	Base	MOL	Dia.	Weight
11PAR30SNDIM/927SP15	E26	3-1/4"	3-11/16"	0.3lb
11PAR30SNDIM/927NF25	E26	3-1/4"	3-11/16"	0.3lb
11PAR30SNDIM/927FL40	E26	3-1/4"	3-11/16"	0.3lb
11PAR30SNDIM/930SP15	E26	3-1/4"	3-11/16"	0.3lb
11PAR30SNDIM/930NF25	E26	3-1/4"	3-11/16"	0.3lb
11PAR30SNDIM/930FL40	E26	3-1/4"	3-11/16"	0.3lb
11PAR30SNDIM/940FL40	E26	3-1/4"	3-11/16"	0.3lb
11PAR30SNDIM/930FL40/B	E26	3-1/4"	3-11/16"	0.3lb

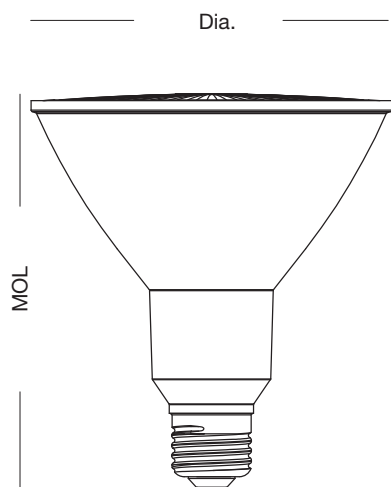

Model	Base	MOL	Dia.	Weight
15.5PAR38DIM/927SP15	E26	5-1/8"	4-5/8"	0.52lb
15.5PAR38DIM/927NF25	E26	5-1/8"	4-5/8"	0.52lb
15.5PAR38DIM/927FL40	E26	5-1/8"	4-5/8"	0.52lb
15.5PAR38DIM/930SP15	E26	5-1/8"	4-5/8"	0.52lb
15.5PAR38DIM/930NF25	E26	5-1/8"	4-5/8"	0.52lb
15.5PAR38DIM/930FL40	E26	5-1/8"	4-5/8"	0.52lb
15.5PAR38DIM/940FL40	E26	5-1/8"	4-5/8"	0.52lb
15.5PAR38DIM/930NF25/B	E26	5-1/8"	4-5/8"	0.52lb
15.5PAR38DIM/930FL40/B	E26	5-1/8"	4-5/8"	0.52lb
15.5PAR38DIM/930FL40/GU24	GU24	5-1/8"	4-5/8"	0.54lb
15.5PAR38/930FL40/277V	E26	5-1/8"	4-5/8"	0.52lb
15.5PAR38/940FL40/277V	E26	5-1/8"	4-5/8"	0.52lb



# REFINE PAR FAMILY

## ILLUMINANCE & CANDELA DISTRIBUTION

6.5PAR20DIM/930SP15

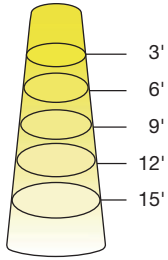

Diameter	Footcandles
0.8	589
1.6	147
2.4	65
3.2	37
3.9	24

6.5PAR20DIM/930NF25

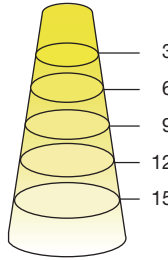

Diameter	Footcandles
1.3	211
2.7	53
4.0	23
5.3	13
6.7	8

6.5PAR20DIM/930FL40

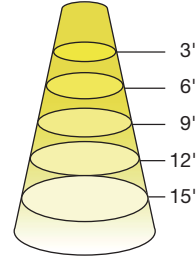

Diameter	Footcandles
2.2	133
4.4	33
6.6	15
8.7	8
10.9	5

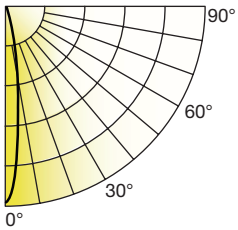

Degree	Candela
0	5300
5	3488
15	564
25	170
35	74
45	40

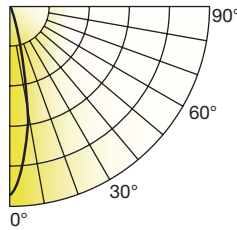

Degree	Candela
0	1900
5	1589
15	638
25	219
35	94
45	51

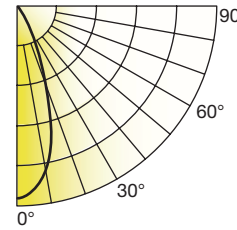

Degree	Candela
0	1200
5	1100
15	725
25	365
35	174
45	76

11PAR30DIM/930SP15

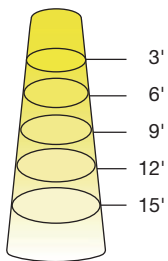

Diameter	Footcandles
0.8	1178
1.6	294
2.4	131
3.2	74
3.9	47

11PAR30DIM/930NF25

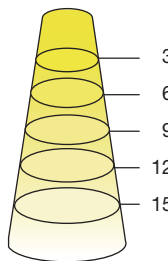

Diameter	Footcandles
1.3	522
2.7	131
4.0	58
5.3	33
6.7	21

11PAR30DIM/930FL40

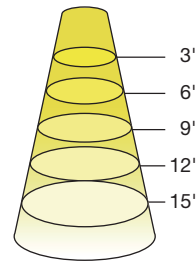

Diameter	Footcandles
2.2	194
4.4	49
6.6	22
8.7	12
10.9	8

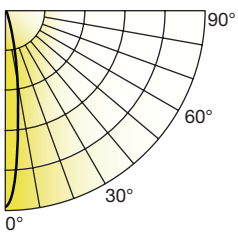

Degree	Candela
0	10600
5	7008
15	958
25	174
35	102
45	68

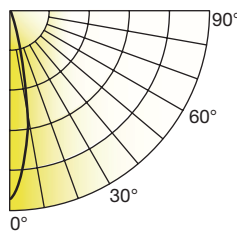

Degree	Candela
0	4700
5	3841
15	1157
25	213
35	81
45	56

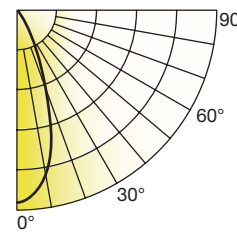

Degree	Candela
0	1750
5	1636
15	991
25	592
35	217
45	64



# REFINE PAR FAMILY

## ILLUMINANCE & CANDELA DISTRIBUTION

11PAR30SNDIM/927SP15

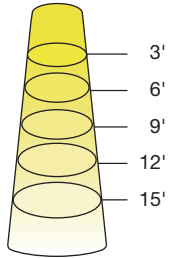

Diameter	Footcandles
0.8	1111
1.6	278
2.4	123
3.2	69
3.9	44

11PAR30SNDIM/930NF25

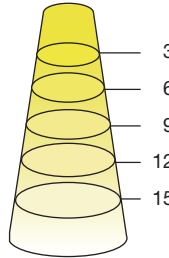

Diameter	Footcandles
1.3	522
2.7	131
4.0	58
5.3	33
6.7	21

11PAR30SNDIM/930FL40

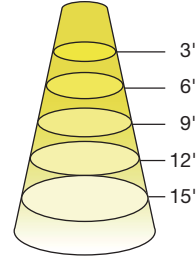

Diameter	Footcandles
2.2	194
4.4	49
6.6	22
8.7	12
10.9	8

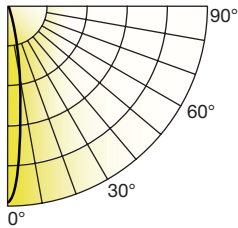

Degree	Candela
0	10600
5	7008
15	958
25	174
35	102
45	68

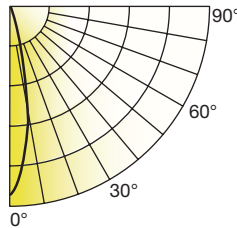

Degree	Candela
0	4700
5	3841
15	1157
25	213
35	81
45	56

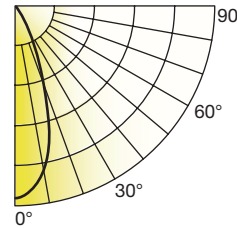

Degree	Candela
0	1750
5	1636
15	991
25	592
35	217
45	64

15.5PAR38DIM/930SP15

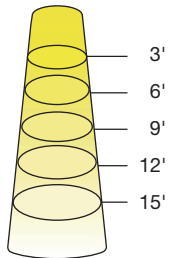

Diameter	Footcandles
0.8	1633
1.6	408
2.4	181
3.2	102
3.9	65

15.5PAR38DIM/930NF25

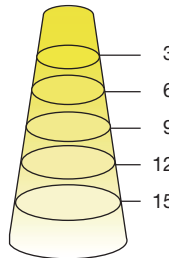

Diameter	Footcandles
1.3	778
2.7	194
4.0	86
5.3	49
6.7	31

15.5PAR38DIM/930FL40

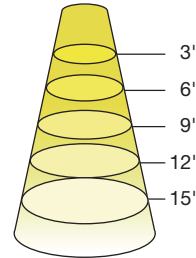

Diameter	Footcandles
2.2	322
4.4	81
6.6	36
8.7	20
10.9	13

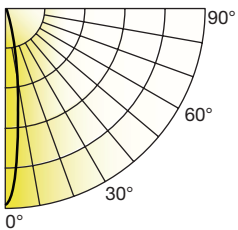

Degree	Candela
0	14700
5	9095
15	1435
25	256
35	93
45	58

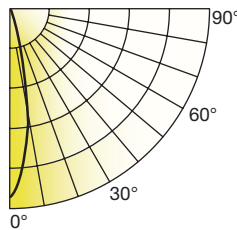

Degree	Candela
0	7000
5	6095
15	1658
25	408
35	137
45	64

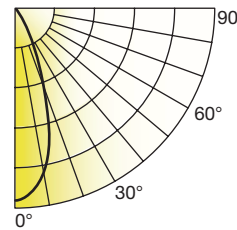

Degree	Candela
0	2900
5	2845
15	1813
25	929
35	300
45	78

For other CCT use the following multiplier: 2700K .98, 4000K 1.02



# REFINE PAR FAMILY

## COLOR ACCURACY & SPECTRAL POWER DISTRIBUTION

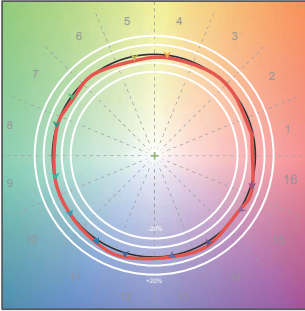
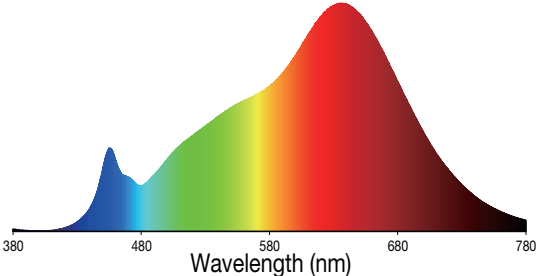
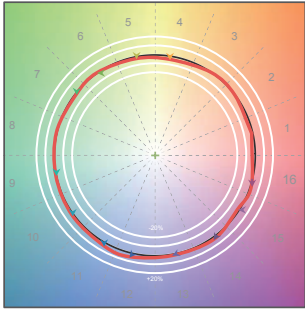
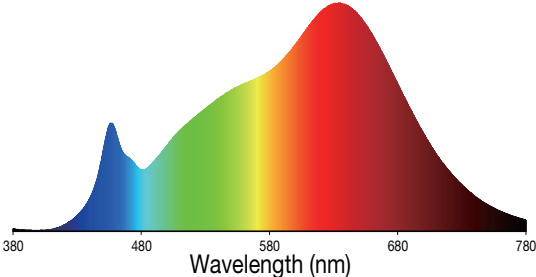
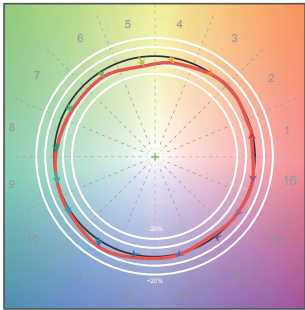
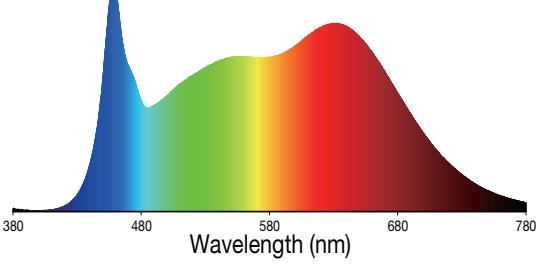
CCT	COLOR ACCURACY	SPECTRAL POWER DISTRIBUTION
2700K	 <p>Rr: 95, Rg: 100</p>	 <p>Wavelength (nm)</p>
3000K	 <p>Rr: 94, Rg: 99</p>	 <p>Wavelength (nm)</p>
4000K	 <p>Rr: 90, Rg: 97</p>	 <p>Wavelength (nm)</p>

Rf: TM-30 metric measuring color fidelity (whether colors are similar to those under natural light). Rf is a more accurate version of the CRI Ra. Rf is 100 for natural light.  
 Rg: TM-30 metric measuring color gamut (whether colors are more saturated than under natural light). Rg is 100 for natural light.