



## LED LUMINAIRES



### EdgeLit Panel Series Field Selectable Light Output & CCT



Halco's ProLED Select EdgeLit Panel is the ideal solution where lighting preferences vary from space to space. The EdgeLit Panel Series is Field Selectable, allowing the installer to select both the preferred light output and color temperature (via DIP Switch) on the product driver box. The benefit of this is that one luminaire can replace 9 SKUs of our regular EdgeLit Panels. Fewer luminaires means less inventory and more efficient job site. At Halco, we only use the highest quality material in our EdgeLit Panel Series design, eliminating the need to worry about yellowing, glare, or drooping after the product is installed. When applications like Healthcare facilities call for multiple lumen packages and color temperatures, the ProLED Select EdgeLit Panel Series is the ideal solution to simplify BOMs and increase customer satisfaction.



**Selectable Color  
Temperature:  
3500K, 4000K, 5000K**

**Selectable Light Output  
via Driver DIP Switch**

**0-10V Dimming Standard**

**Emergency Back-Up Options**

**5-Year Warranty**

**Low Glare Rating**

#### **Applications:**

- Office
- Retail
- Healthcare
- Education
- Hospitality

# ProLED® Select EdgeLit Panel Series

## Field Selectable Light Output & CCT

Product #: \_\_\_\_\_ Type: \_\_\_\_\_  
 Project: \_\_\_\_\_ Date: \_\_\_\_\_  
 Comments: \_\_\_\_\_ Initials: \_\_\_\_\_

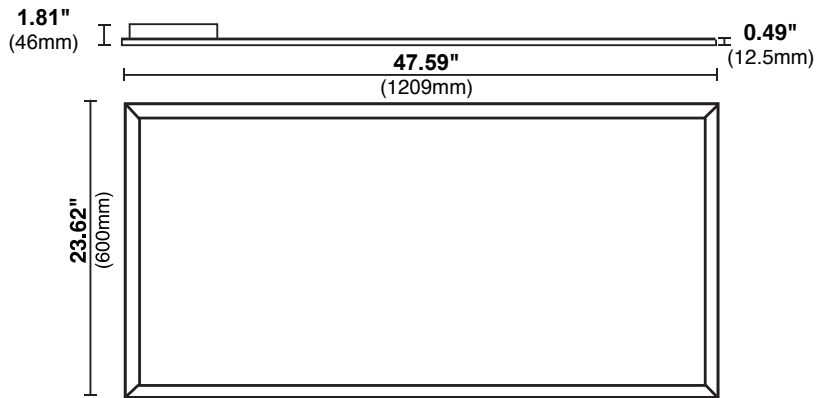
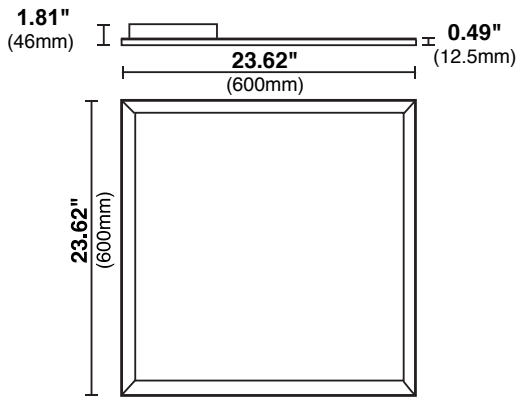
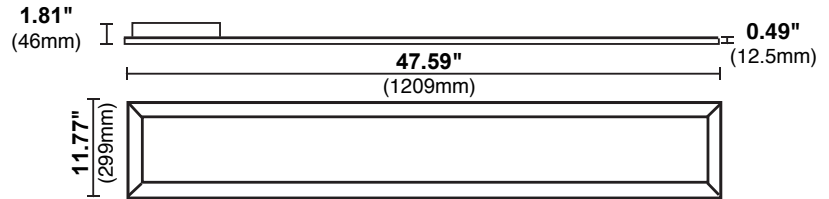

### Performance

- Field Selectable Light Output
  - 1x4 Selectable 25W, 30W, 40W
  - 2x2 Selectable 25W, 30W, 40W
  - 2x4 Selectable 30W, 35W, 45W
- Overall Efficacy >110 lm/W
- Field Selectable CCT
  - 3500K, 4000K, 5000K
- CRI >80
- 0-10V Dimming Standard
- Universal 120-277VAC
- L70 Lumen Maintenance > 50,000 hours at 25°C

### Design

- Designed for fast and easy install
- UGR <19
- Sleek and Modern Design

### Certification

- UL Listed
- RoHS Compliant
- Damp Location
- IC Rated
- IP40 Rated

### Construction

- Field Adjustable Driver via DIP Switch
- PMMA Lens Material
- Die-Cast Steel Housing

### Ordering Information

Product Code	Product Number	Product Description
14FSEPL/8DU	10330	FIELD SELECTABLE EDGE LIT PANEL; 1X4, 80 CRI, 0-10V DIMMING, 120-277V, SELECTABLE CCT: 3500K, 4000K, 5000K; SELECTABLE WATTAGE: 25W, 30W, 40W
22FSEPL/8DU	10331	FIELD SELECTABLE EDGE LIT PANEL; 2X2, 80 CRI, 0-10V DIMMING, 120-277V, SELECTABLE CCT: 3500K, 4000K, 5000K; SELECTABLE WATTAGE: 25W, 30W, 40W
24FSEPL/8DU	10332	FIELD SELECTABLE EDGE LIT PANEL; 2X4, 80 CRI, 0-10V DIMMING, 120-277V, SELECTABLE CCT: 3500K, 4000K, 5000K; SELECTABLE WATTAGE: 30W, 35W, 45W

# ProLED® Select EdgeLit Panel Series

## Field Selectable Light Output & CCT

Product #: \_\_\_\_\_ Type: \_\_\_\_\_  
 Project: \_\_\_\_\_ Date: \_\_\_\_\_  
 Comments: \_\_\_\_\_ Initials: \_\_\_\_\_

### Specification Table

	14FSEPL/8DU	22FSEPL/8DU	24FSEPL/8DU
Factory Default Wattage	40W	40W	45W
Input Voltage	120-277VAC		
Power Factor	<.9		
L70 Lifetime*	>50,000 Hours		
CRI	>80		
Dimming	0-10V		
Wet Listings	IP40, ETL Listed for Damp Locations		
Selectable CCT	3500K, 4000K, 5000K		
Ambient Operating Temperature	-20°C-40°C		

\*Useful Life is defined as the point in time at which the lamp will maintain at least 70% of its initial lumens. The lamp will continue to operate past this point at decreased light levels. May not be compatible with all dimming systems, dimming performance may vary by system.  
 Warranty – Commercial / Industrial: This product is warranted for 5 years from the date of purchase.

Ceiling Designation	Fixture Dimensions: in. (mm)	Net Weight
2x2'	23.62"x23.62"x1.81" (600x600x46mm)	6.61 lbs. (3.0kg)
1x4'	11.77"x47.59"x1.81" (1209x299x46mm)	7.05 lbs. (3.2kg)
2x4'	23.62"x47.59"x1.81" (600x1209x46mm)	12.12 lbs. (5.5kg)

### Emergency Battery Option

Product Code	Product Number	Watt	Volts
VPL/EM/LED3	81981	8 Watt	120-277V



### Performance Table

Model	Input Voltage (V)	Lamp Watt (W)	CRI	Lumen Output (lm)	CCT
10330 1'x4' Selectable panel	120-277	25/30/40W	80	2500/3000/4000lm	3500K-4000K-5000K
10331 2'x2' Selectable panel	120-277	25/30/40W	80	2500/3000/4000lm	3500K-4000K-5000K
10332 2'x4' Selectable panel	120-277	30/35/45W	80	3000/3500/5000lm	3500K-4000K-5000K

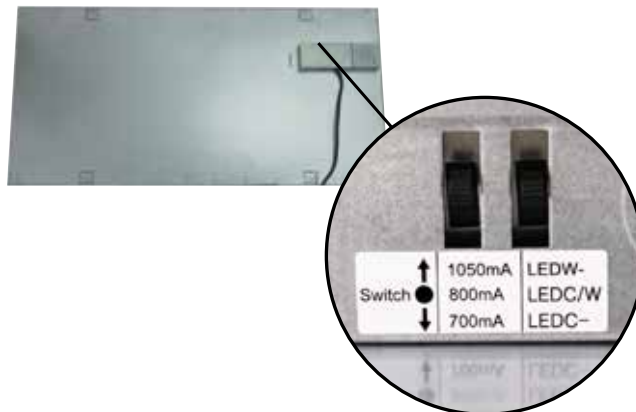

# ProLED® Select EdgeLit Panel Series

## Field Selectable Light Output & CCT

Product #: \_\_\_\_\_ Type: \_\_\_\_\_

Project: \_\_\_\_\_ Date: \_\_\_\_\_

Comments: \_\_\_\_\_ Initials: \_\_\_\_\_

### Photometrics

1' x 4'

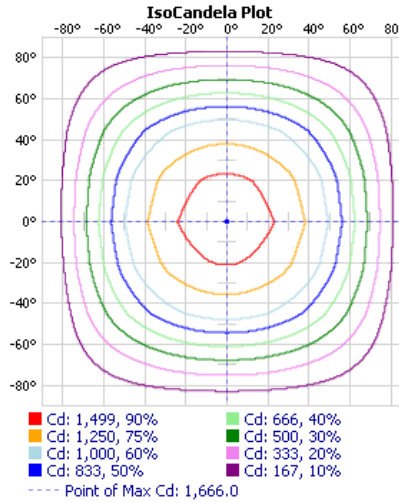
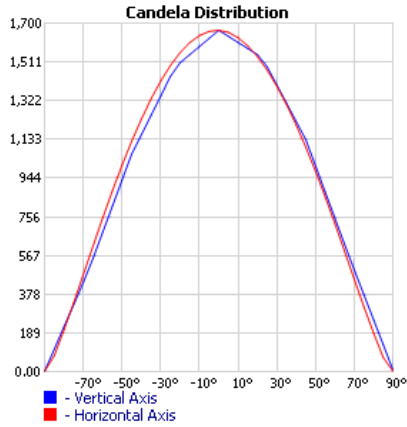

#### ZONAL LUMEN SUMMARY

ZONE	LUMENS	% LAMP	% LUMINAIRE
0-30	1,268.7	26.8%	26.9%
0-40	2,075.2	43.9%	43.9%
0-60	3,672.5	77.7%	77.8%
60-90	1,050.4	22.2%	22.2%
0-90	4,722.9	99.9%	100%

#### LUMENS PER ZONE

ZONE	LUMENS	% TOTAL
0-10	155.3	3.3%
10-20	442.1	9.4%
20-30	671.3	14.2%
30-40	806.6	17.1%
40-50	838.6	17.8%
50-60	758.7	16.1%
60-70	582.6	12.3%
70-80	352.9	7.5%
80-90	114.9	2.4%

2' x 2'

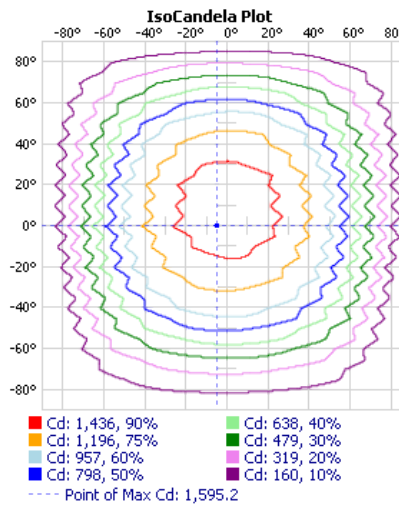
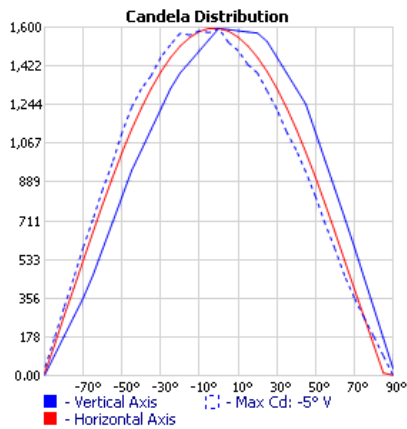

#### ZONAL LUMEN SUMMARY

ZONE	LUMENS	% LAMP	% LUMINAIRE
0-30	1,226.9	26.3%	26.3%
0-40	2,014.8	43.2%	43.2%
0-60	3,593.8	77%	77.1%
60-90	1,067.3	22.9%	22.9%
0-90	4,661.1	99.8%	100%

#### LUMENS PER ZONE

ZONE	LUMENS	% TOTAL
0-10	149.2	3.2%
10-20	426.5	9.1%
20-30	651.2	14.0%
30-40	787.9	16.9%
40-50	826.1	17.7%
50-60	752.9	16.2%
60-70	584.4	12.5%
70-80	359.3	7.7%
80-90	123.6	2.7%

2' x 4'

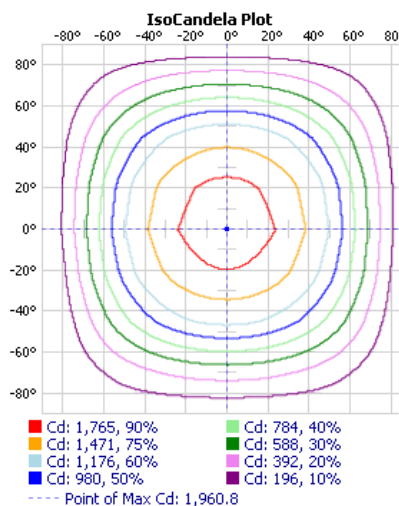
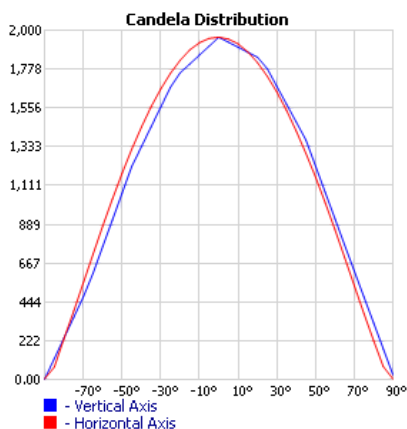

#### ZONAL LUMEN SUMMARY

ZONE	LUMENS	% LAMP	% LUMINAIRE
0-30	1,495.3	26.8%	26.9%
0-40	2,446.9	43.9%	43.9%
0-60	4,332.5	77.7%	77.8%
60-90	1,236.4	22.2%	22.2%
0-90	5,568.8	99.9%	100%

#### LUMENS PER ZONE

ZONE	LUMENS	% TOTAL
0-10	182.9	3.3%
10-20	520.9	9.4%
20-30	791.4	14.2%
30-40	951.6	17.1%
40-50	990.1	17.8%
50-60	895.5	16.1%
60-70	685.9	12.3%
70-80	413.1	7.4%
80-90	137.4	2.5%