

# PL RETROFITS 4 PIN TYPE A/B UNIVERSAL

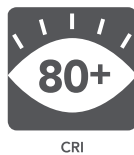

## Universal PL Lamps

high output

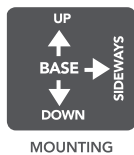
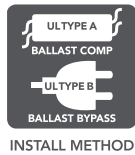
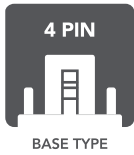

LED-7320  
Omni-Directional

quad-tube design

- Replace CFL lamps with reliable, long-lasting, energy efficient LED
- Universal products operate on 120-277V or a compatible ballast
- 10W, 11W and 12W replacing up to 42W CFL lamps
- Up to 1,600 lumen output
- Suitable for damp environments and semi-enclosed recessed fixtures (Not for use in enclosed fixtures)
- Rotating base on LED-7324 allows for optimal light output



LED-7318  
Vertical

extension available (LED-7319)

rotating base



LED-7324  
Horizontal

PART #	REPLACES UP TO	WATTAGE	LUMENS	CCT (K)	BASE
LED-7318-40A	26W 4 Pin CFL	12W	1198	4000K	G/GX24q
LED-7320-40K-G3	42W 4 Pin CFL	10W	1600	4000K	G/GX24q
LED-7324-40K-G3	42W 4 Pin CFL	11W	1200	4000K	G/GX24q

\*For ballast compatibility list, see page 3



LIGHT EFFICIENT DESIGN HEADQUARTERS 188 S. Northwest Highway • Cary, IL 60013  
 INNOVATION & MANUFACTURING CENTER 30 Log Bridge Road, Building 200 • Middleton, MA 01949  
 847.380.3540 • led-llc.com

01.08.20 Information is subject to change without notice.

# PL RETROFITS 4 PIN TYPE A/B UNIVERSAL

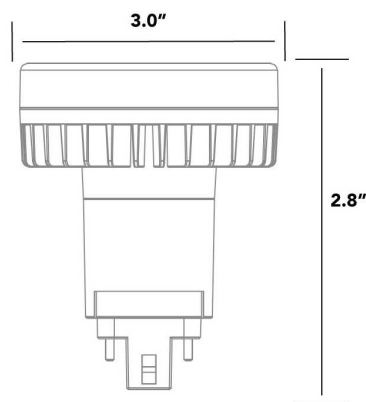

LED-7318

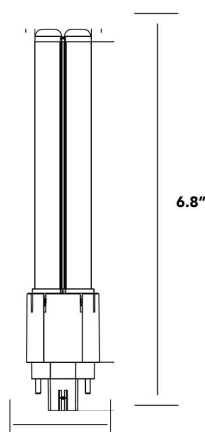

LED-7320

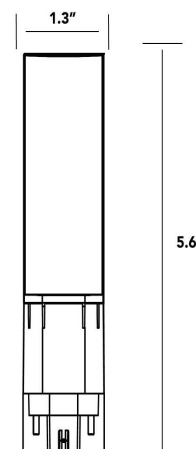

LED-7324

## ORDERING GUIDE

PART #	UPC	REPLACES	WATTAGE	LUMENS	CCT (K)	BASE
LED-7318-27A	844006073503	26W 4 Pin CFL	12W	837	2700K	G/GX24q
LED-7318-35A	844006073510	26W 4 Pin CFL	12W	1157	3500K	G/GX24q
LED-7318-40A	844006073527	26W 4 Pin CFL	12W	1198	4000K	G/GX24q
LED-7320-27K-G3	844006024703	42W 4 Pin CFL	10W	1350	2700K	G/GX24q
LED-7320-35K-G3	844006024727	42W 4 Pin CFL	10W	1550	3500K	G/GX24q
LED-7320-40K-G3	844006024734	42W 4 Pin CFL	10W	1600	4000K	G/GX24q
LED-7320-50K-G3	844006024741	42W 4 Pin CFL	10W	1635	5000K	G/GX24q
LED-7324-27K-G3	844006024758	42W 4 Pin CFL	11W	1050	2700K	G/GX24q
LED-7324-35K-G3	844006024772	42W 4 Pin CFL	11W	1125	3500K	G/GX24q
LED-7324-40K-G3	844006024789	42W 4 Pin CFL	11W	1200	4000K	G/GX24q
LED-7324-50K-G3	844006024796	42W 4 Pin CFL	11W	1200	5000K	G/GX24q

### Additional Notes:

- This lamp is not compatible with all electronic ballasts. If the ballast is not listed as compatible, then bypass the ballast and run on 120-277VAC Line Volatage.
- Instructions available on [led-llc.com](http://led-llc.com)
- Do not use in fully enclosed fixtures
- Non-Dimmable
- For dimming applications, LED-7330 or 7334 may work better



**Light Efficient Design**

LIGHT EFFICIENT DESIGN HEADQUARTERS 188 S. Northwest Highway • Cary, IL 60013  
 INNOVATION & MANUFACTURING CENTER 30 Log Bridge Road, Building 200 • Middleton, MA 01949  
 847.380.3540 • [led-llc.com](http://led-llc.com)

# PL RETROFITS 4 PIN TYPE A/B UNIVERSAL



## LED-7318 BALLAST COMPATIBILITY LIST

COMPATIBLE BALLASTS		1 LAMP		2 LAMP	
		120V	277V	120V	277V
PHILIPS / ADVANCE	2S13-H1-LD	✓	✓	✓	✓
	2S18-H1-LD	✓	✓	✓	✓
	2S26-H1-LD	✓	✓	✓	✓
	2S42-M2-LD	✓	✗	✓	✓
UNIVERSAL / TRIAD	C213UNVME	✓	✓	✓	✓
	C218UNVME	✓	✓	✓	✓
	C2642UNVME	✓	✓	✓	✓
	C242UNVME	✓	✗	✓	✗
OSRAM / SYLVANIA	QTP1/2X18CF/UN DM	✓	✓	✓	✓
	QTP 2X26CF/UNV DM	✓	✓	✓	✓

\*For full LED-7318 ballast compality list, see instruction sheet

## LED-7320-G3 LED-7324-G3 BALLAST COMPATIBILITY LIST

COMPATIBLE BALLASTS		1 LAMP		2 LAMP	
		120V	277V	120V	277V
PHILIPS / ADVANCE	2S13-H1-LD	✓	✓	✓	✓
	2S18-H1-LD	✓	✓	✓	✓
	2S26-H1-LD	✓	✓	✓	✓
	2S42-M2-LD	✓	✓	✓	✓
UNIVERSAL / TRIAD	C213UNVME	✓	✓	✓	✓
	C218UNVME	✓	✓	✓	✓
	C2642UNVME	✓	✓	✓	✓
	C242UNVME	✓	✗	✓	✗
OSRAM / SYLVANIA	QTP1/2X18CF/UN DM	✓	✓	✓	✓
	QTP 2X26CF/UNV DM	✓	✓	✓	✓
KEYSTONE	KTEB-226-UV-TP-PIC-DW	✓	✓	✓	✓

✓ = COMPATIBLE  
✗ = NOT COMPATIBLE



LIGHT EFFICIENT DESIGN HEADQUARTERS 188 S. Northwest Highway • Cary, IL 60013  
INNOVATION & MANUFACTURING CENTER 30 Log Bridge Road, Building 200 • Middleton, MA 01949  
847.380.3540 • led-llc.com

01.08.20 Information is subject to change without notice.