

3

Cut all wires to ballast (close to ballast case). Either remove ballast or keep it in place.

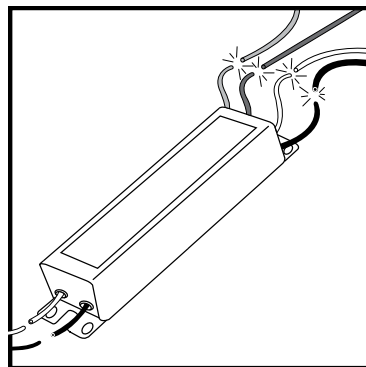

5

Choose one side of the fixture as the "power" side. Connect the black "live" to each lamp holder on the power side per the wiring diagram. Connect the white wire "neutral" to each lamp holder on the "power" side of the fixture per the wiring diagram. Use UL approved and appropriately rated wire connectors for any connections that may be required.

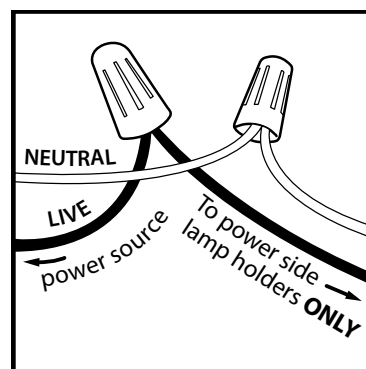

4

Inspect lamp holders, ballast, and wiring to ensure these lamp holders are NON SHUNTED LAMP HOLDERS. TCP LiberaT5 Series lamps do not require a ballast to operate. They have an internal LED driver that operates on 120-277V. These tubes require power to only one end of the fixture, called the "power" side. The TCP LiberaT5 lamp is clearly marked at one end to signify power end. This must be installed in "power" end. The lamp holders (or tombstones) must be non-shunted as the power flows through the LED T5 tube. (Shunt means "an electrical conductor joining two points of a circuit, through which more or less of a current may be diverted"). Both "power" end and opposite end must both have unshunted tombstones. The "opposite" end acts as simply a mechanical holder with TCP LED LiberaT5 lamps.

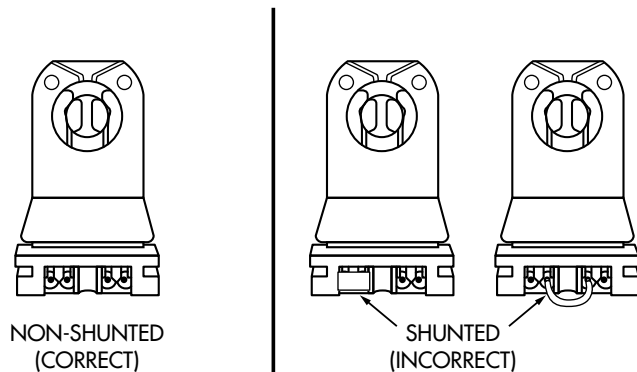

6

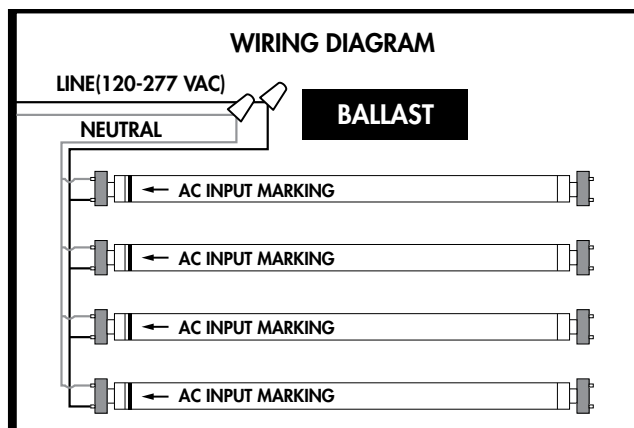
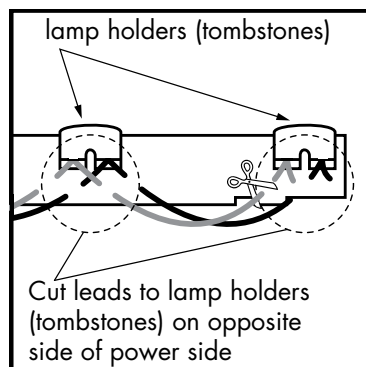

Diagram of fixture with ballast removed.

7



Cut the wire leads from the lamp holders (tombstones) on the "opposite" end (non-powered side) of the fixture.

8

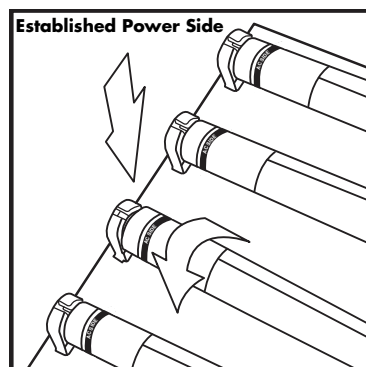

Install ballast cover. Install LiberaT5 lamps, ensuring power end is installed on "power" side of fixture.

9

Apply the provided label. Fluorescent lamp holders within this fixture have been rewired to line voltage and will no longer operate the original fluorescent lamp. Place this label on the ballast cover on "power" side of fixture. THIS LUMINAIRE HAS BEEN MODIFIED TO OPERATE LED LAMPS. DO NOT ATTEMPT TO INSTALL OR OPERATE FLUORESCENT LAMPS IN THIS LUMINAIRE. Use only TCP LiberaT5 LED Bypass Lamps, Model# LT5HO25B1XXK."

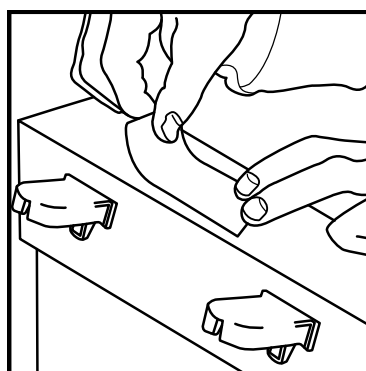

10

Switch Power ON

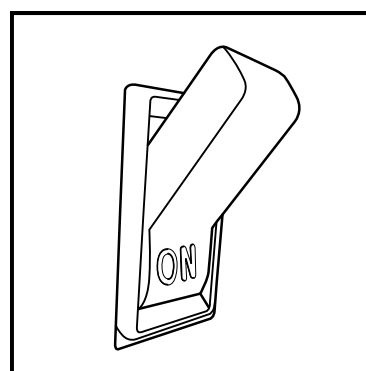

## IMPORTANT SAFETY INSTRUCTIONS

**WARNING** – Installation of LiberaT5 series LED lamp or lamps is intended to replace one or more existing 4 foot fluorescent tubes as used in dry or damp rated 4 foot luminaire containing unshunted lamp holders (tombstones). Existing fluorescent tubes must have a minimum spacing of 2 inches between the side of the neighboring fluorescent lamp when LiberaT5 is to be installed in a multi-tube luminaire.

PRIOR TO INSTALLING LIBERAT5 SERIES LAMPS, PLEASE TURN POWER OFF TO FIXTURE.

EXAMINE ALL PARTS THAT ARE NOT INTENDED TO BE REPLACED BY THE RETROFIT KIT FOR DAMAGE AND REPLACE ANY DAMAGED PARTS PRIOR TO INSTALLATION OF THE RETROFIT KIT.

THE LIBERAT5 SERIES LAMP IS RATED FOR SUPPLY VOLTAGE BETWEEN 120V AND 277V. VERIFY THAT SUPPLY VOLTAGE IS BETWEEN 120V AND 277V.

THIS PRODUCT SERIES IS NOT TO BE USED WITH FLUORESCENT LAMP BALLAST.

THIS DEVICE IS NOT INTENDED FOR USE WITH EMERGENCY EXIT FIXTURES.

NOT FOR USE WITH DIMMERS.

**NOT FOR USE WITH SHUNTED LAMP HOLDERS.**

THIS PRODUCT SHALL BE INSTALLED IN ACCORDANCE WITH THE LATEST UL SAFETY, NEC AND/OR LOCAL AUTHORITY HAVING JURISDICTION. INSTALLATION SHALL BE PERFORMED BY A QUALIFIED ELECTRICIAN UNDERSTANDING THE CONSTRUCTION AND OPERATION OF THIS PRODUCT AND THE ELECTRICAL REQUIREMENTS INVOLVED.

THIS RETROFIT KIT IS ACCEPTED AS A COMPONENT OF A LUMINAIRE WHERE THE SUITABILITY OF THE COMBINATION SHALL BE DETERMINED BY AUTHORITIES HAVING JURISDICTION

Installers should not disconnect existing wires from lampholder terminals to make new connections at lampholder terminals. Instead installers should cut existing lampholder leads away from the fluorescent ballast and make new electrical connections to lampholder lead wires by employing applicable UL listed connectors.

Do not make or alter any open holes in an enclosure of wiring or electrical components during kit installation.

**WARNING** – To prevent wiring damage or abrasion, do not expose wiring to edges of sheet metal or other sharp objects.

**WARNING** – Risk of fire or electric shock. LED Retrofit Kit installation requires knowledge of luminaires electrical systems. If not qualified, do not attempt installation. Contact a qualified electrician.

**WARNING** – Risk of fire or electric shock. Install this kit only in luminaires that have the construction features and dimensions shown in the photographs and/or drawings and where the input rating of the retrofit kit does not exceed the input rating of the luminaire.

**WARNING** – To avoid potential fire or shock hazard, do not use this retrofit kit in luminaires employing shunted bi-pin lampholders. Note: Shunted lamp holders are found only in fluorescent luminaires with Instant-Start ballasts. Instant-start ballasts can be identified by the words "Instant Start" or "I.S." marked on the ballast. This designation may be in the form of a statement pertaining to the ballast itself, or may be combined with the marking for the lamps with which the ballast is intended to be used, for example F40T12/IS. For more information, contact the LED luminaire retrofit kit manufacturer.

**Replace with LT5HO25B1XXK, LT5HO12B1XXK, LT5HO16B1XXK, LT5HE09B1XXK, LT5HE12B1XXK or LT5HE13B1XXK where XX indicates color temperature.**

1

Switch Power OFF

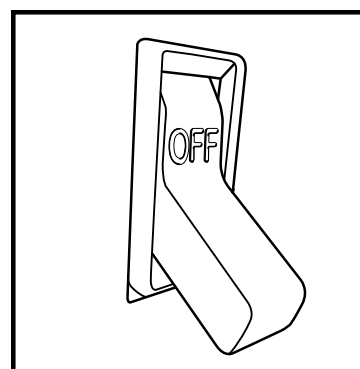

2

Remove fluorescent lamps. Dispose of fluorescent lamps per local requirements and codes for mercury disposal. Gain access to ballast by removing cover.

