

Installation Instructions

TYPE A(Slip-fitter)

Step 1: Loosen the 4 screws on the lamp holder, connect the wires correctly and put the wires into the lamp pole, then lock the screws well to fix the lamp on the lamp pole.

Step 2: Loosen the locking bolt with tools, rotate the lamp and lock the screw after determining required angle.

Notice: Locking bolt can be only compatible with a lamp pole that the outer diameter is $\phi 60$, lamp adjustable angle is $0-90^\circ$

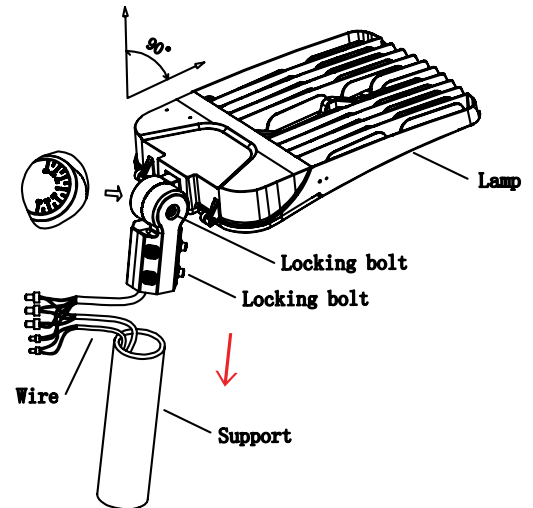

TYPE B(Square/Round pole mount with slip-fitter function)

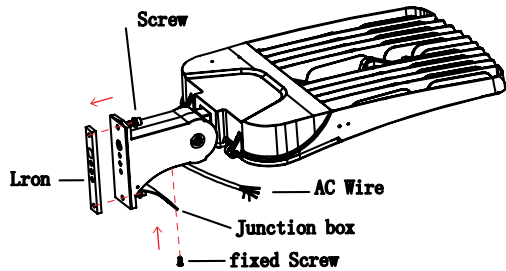

Step 1. Use tools to take screw apart and put installed iron bar away, remove fixed screw and open junction box, then pass the AC wire through it.

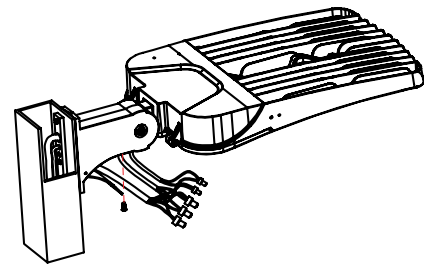

Step 2. Use tools to fix the lamp on square lamp pole, connect the wires correctly and make waterproof measures well, close the junction box and finish installation.

Step 3. Notice: Remove the rubber mat when the lamp is installed on round lamp pole

Notice: Lamp adjustable angle is $0-30^\circ$

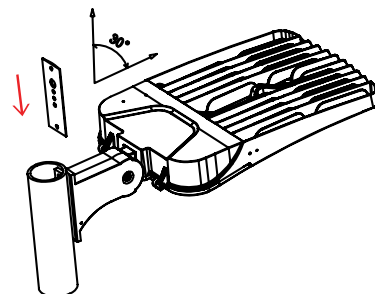

TYPE C(Square/Round pole mount)

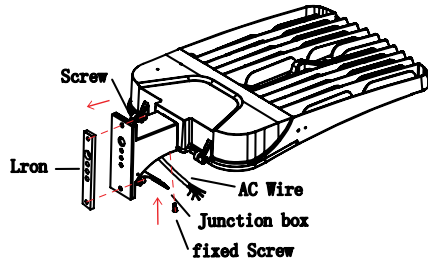

Step 1. Use tools to take screw apart and put installed iron bar away, remove fixed screw and open junction box, then pass the AC wire through it.

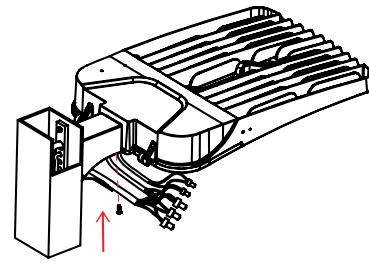

Step 2. Use tools to fix the lamp on square lamp pole, connect the wires correctly and make waterproof measures well, close the junction box and finish installation.

Notice: Remove the rubber mat when the lamp is installed on round lamp pole.

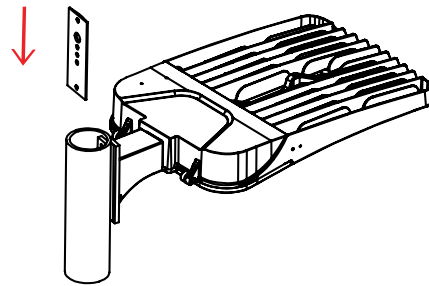

TYPE D(Trunnion)

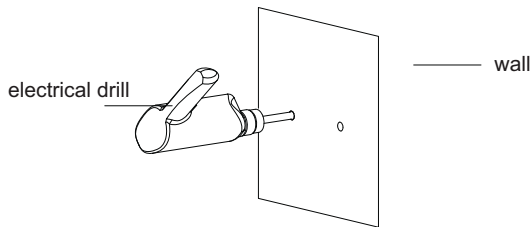

Step 1. Mark the position of the fixing holes with foold lightbracket, then drill the fixing holes.

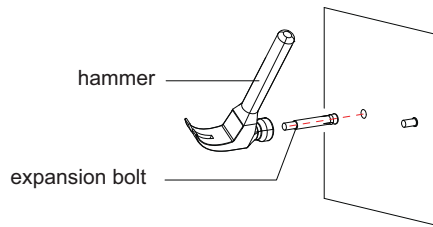

Step 2. Input two expansion bolts.

Step 3: Waterproof measures must be taken after connecting the wire correctly, install the lamp well after putting the wires back into the trunking.
Attention: Lamp adjustable angle is 0-90°

