

# Installation Instructions



## Cautions:

1. Can not use the electric generator to test the LED lamp.
2. Please abide by related country, regional and local law and regulations when install this fixture.
3. To avoid electrical shock and damage, please do not install the lights in raining days.

## Notices:

1. To prevent from electric shock or fire risk, the installation must be conducted by operator who have professional electrical knowledge.
2. Please wear gloves to avoid injury before installing lamps.
3. During or after installation, if there are situations such as smoke, fire in the wires or lamps, please turn off the power immediately and notify relevant personnel of an overhaul.
4. This light can be used for outdoor installation.

## Instructions:

- 1 This product has dimming and non-dimming function, which differs in installation ways.
- 3 kind of dimming functions are available in this high bay light:
  - Constant current can be achieved by 1-10VDC dimming.
  - PWM signal dimming.
  - Variation of resistance unit dimming(Please choose the appropriate dimming way according to your needs. You can also choose not to use this function)
- 3 Choose the wire connection ways, dimming ways and installation ways according to your needs and the led fixture purchased.

The Installation must be carried out by a qualified electrician.

## Wiring Diagram:

100-277V

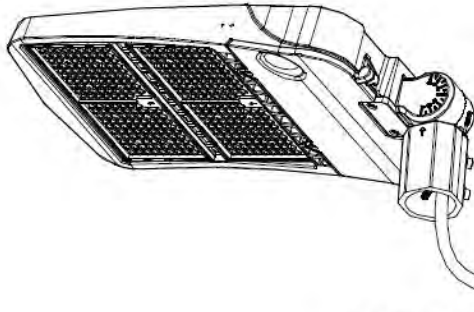

As for the wire color of  
DIM + and DIM - , pls check  
the lamp label !

Black/Brown:ACL  
Green/Yellow  
White/Blue:ACN  
GRAY: DIM+  
PURPLE: DIM-

277-480V

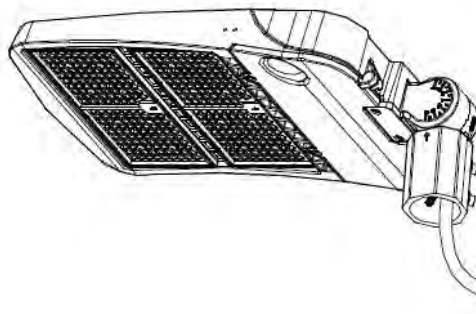

Black/Brown:ACL  
Green/Yellow  
White/Blue:ACN

# Optional Brackets and Installation Instructions

1. There are 5 optional brackets for this fixture. The following is shoebox fixtures with different brackets.

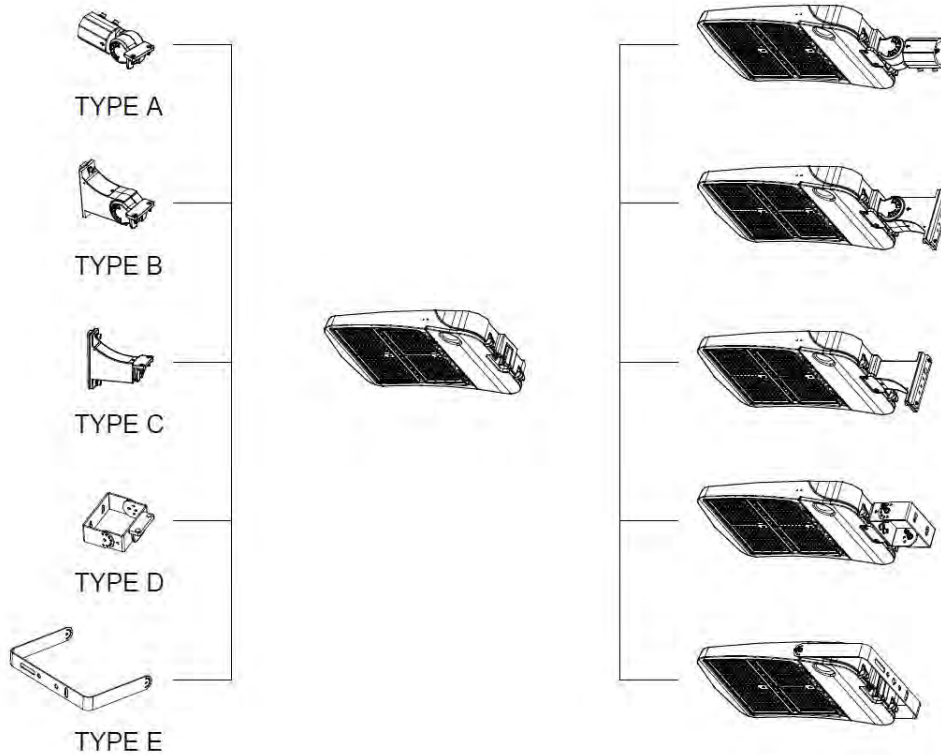

## 2. Installation Instructions with different brackets.

### 2-1 Slip-fitter(TYPE A)

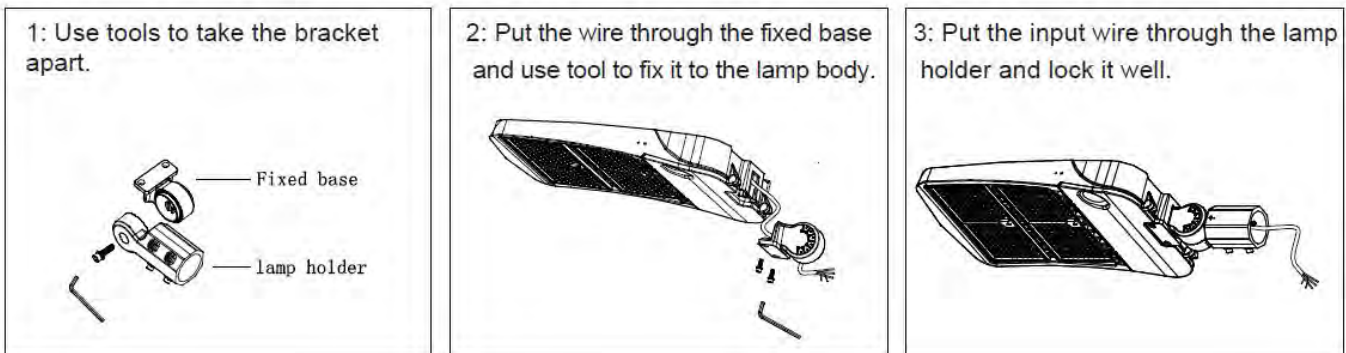

### 2-2 Square/Round pole mount with slip-fitter function (TYPE B)

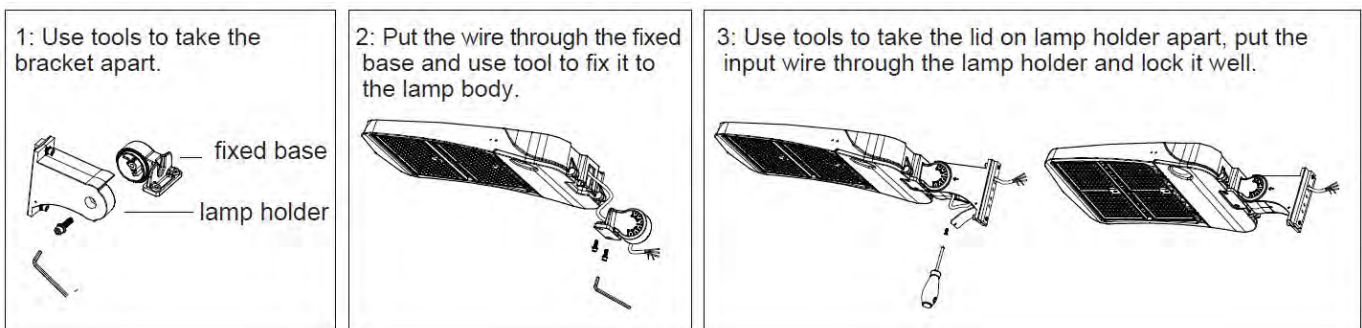

### 2-3 Square/Round pole mount (TYPE C)

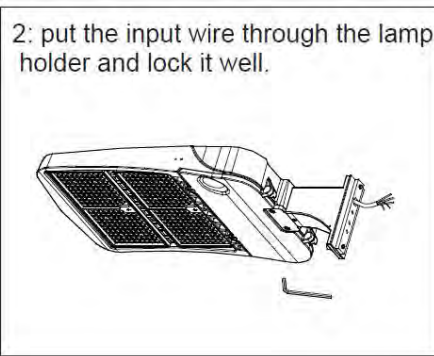
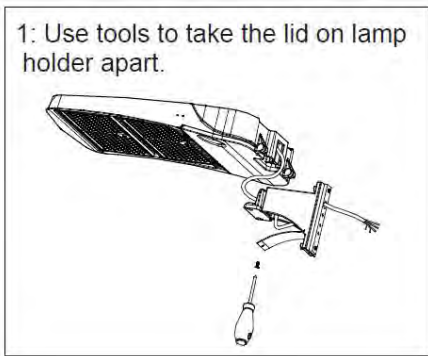

### 2-4 Trunnion(TYPE D)

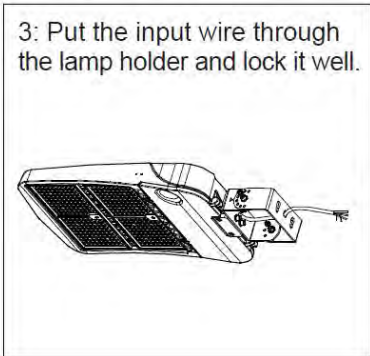
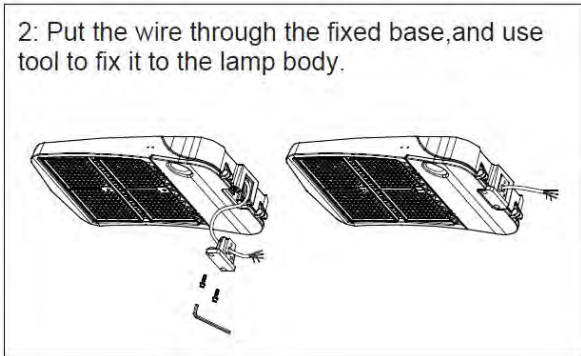
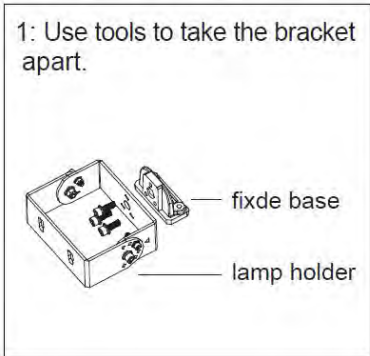

### 2-5 Yoke(TYPE E)

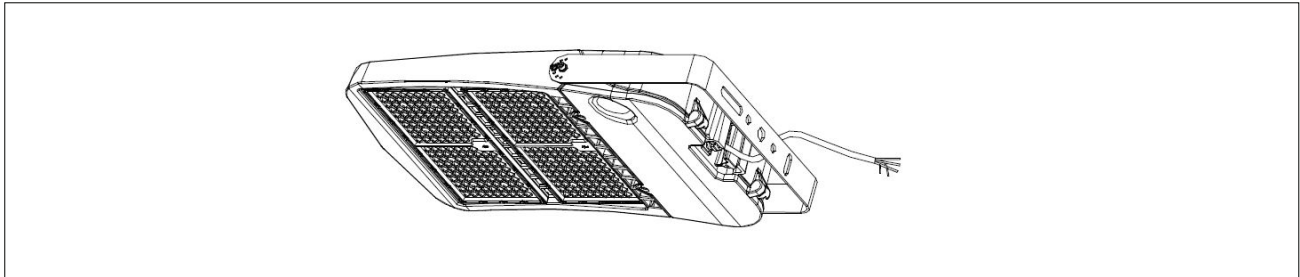

## Installation of LED Lamps:

### Installation I: Slip-fitter(TYPE A)

1: Loosen the 4 screws on the lamp holder, connect the wires correctly and put the wires into the lamp pole, then lock the screws well to fix the lamp on the lamp pole. 2: Loosen the locking bolt with tools, rotate the lamp and lock the screw after determining required angle.

Notice: Locking bolt can be only compatible with a lamp pole that the outer diameter is  $\phi 60$ , lamp adjustable angle is 0-90°

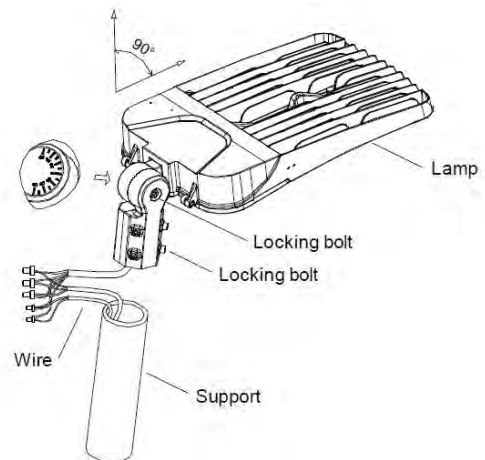



Installation II: Square/Round pole mount(TYPE B)

1. Use tools to take screw apart and put installed iron bar away, remove fixed screw and open junction box, then pass the AC wire through it.

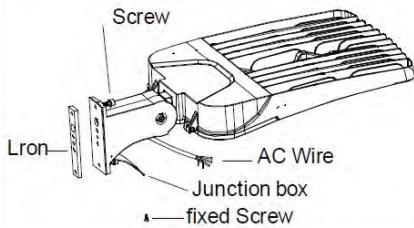

2. Use tools to fix the lamp on square lamp pole, connect the wires correctly and make waterproof measures well, close the junction box and finish installation.

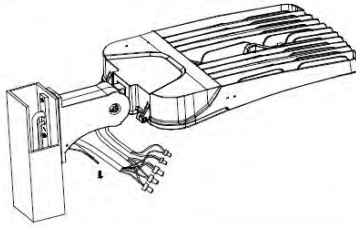

3. Notice: Remove the rubber mat when the lamp is installed on round lamp pole. Lamp adjustable angle is 0-30°

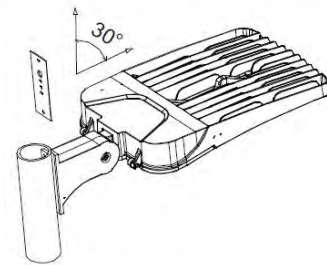

Installation III: Square/Round pole mount with slip-fitter function(TYPE C)

1. Use tools to take screw apart and put installed iron bar away, remove fixed screw and open junction box, then pass the AC wire through it.

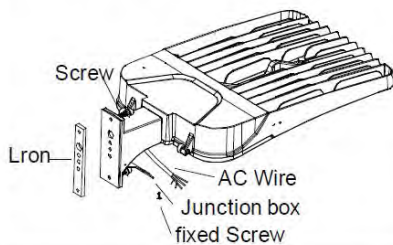

2. Use tools to fix the lamp on square lamp pole, connect the wires correctly and make waterproof measures well, close the junction box and finish installation.

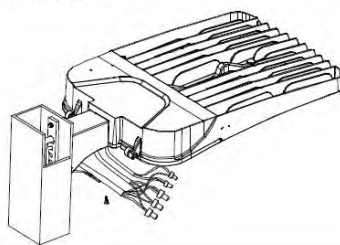

3. Notice: Remove the rubber mat when the lamp is installed on round lamp pole.

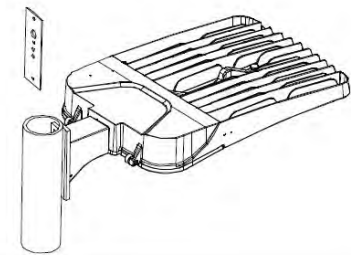

Installation IV: Trunnion(TYPE D)

1: As is shown, drill two  $\phi 10$  holes on the wall.

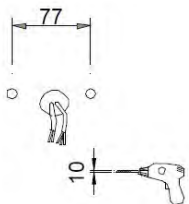

2: Input two expansion bolts.

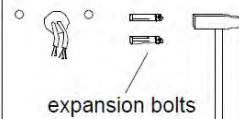

3: Waterproof measures must be taken after connecting the wire correctly, install the lamp well after putting the wires back into the trunking. Attention: Lamp adjustable angle is 0-90°

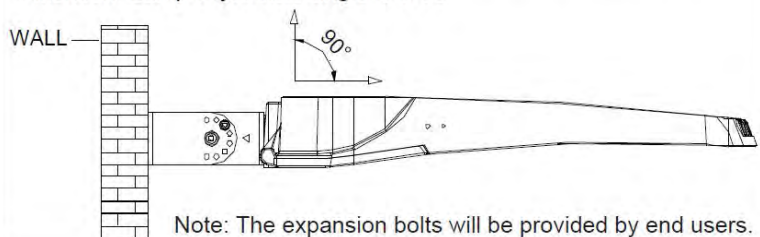

Note: The expansion bolts will be provided by end users.

Installation V: Yoke(TYPE E)

1: As is shown, drill two  $\phi 10$  holes on the wall.

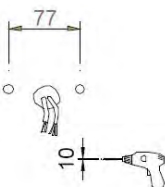

2: Input two expansion bolts.

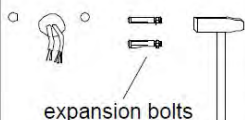

3: Waterproof measures must be taken after connecting the wire correctly, install the lamp well after putting the wires back into the trunking. Attention: Lamp adjustable angle is 0-90°

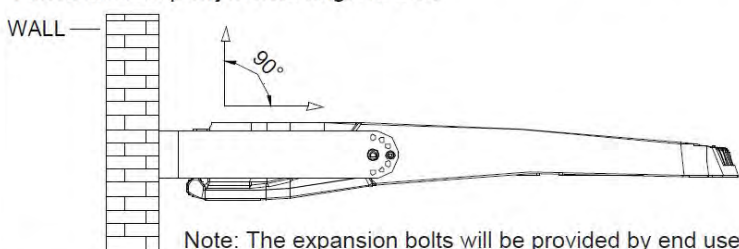

Note: The expansion bolts will be provided by end users.

## Attention:

1 Dust cover should be installed well before installation when selecting the PIR sensor or Microwave sensor. The induction time can be adjusted as user requirement specification.

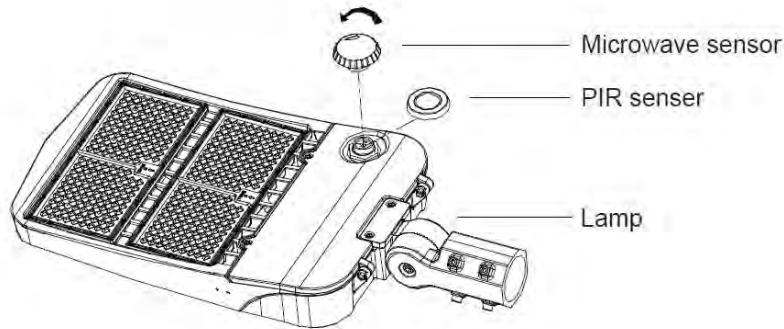

## PARAMETER SETTING BY DIP SWITCH

Consider the picture: 1, 2 set sensitivity; 3, 4 set hold time; 5, 6 set the lux; 7,8 stand-by light level; 9, 10 set-by time;

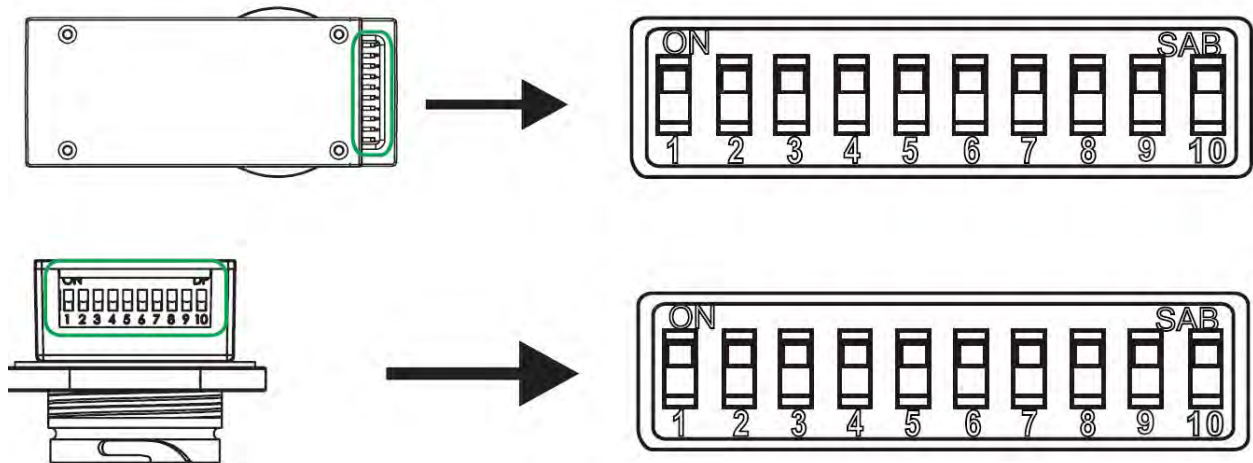

## Detection Range Setting (sensitivity)

Detection range is the term used to describe the radii of the more or less circular detection zone produced on the ground after mounting the sensor light at a height of 40ft, pull switch to the ON position as "↑", pull switch to the OFF position as "↓", switch location and detection range of the corresponding table is as follows:



## Hold Time Setting

The light can be set to stay ON for any period of time between approx. 10sec and a maximum of 60min. Any movement detected before this time elapse will re-start the timer. It is recommended to select the shortest time for adjusting the detection zone and for performing the walk test.

Pull switch to the ON position as "↑", pull switch to the OFF position as "↓", switch location and detection range of the corresponding table is as follows:



## Light-control Setting

The chosen light response threshold can be infinitely from approx. 10-50lux, pull switch to the ON position as "↑", pull switch to the OFF position as "↓", switch location and light-control of the corresponding table as follows:



## Stand-by Light Level Setting

Switch to the ON is "↑", switch to the OFF is "↓"; the corresponding file of switch location and detection distance as follows:



## Stand-by Time Setting

File of switch location and detection distance as follow: file of switch location and detection distance as follow:



# PARAMETER SETTING BY REMOTE CONTROL IN MANUAL OF RC-100

## Wiring Diagrams

BRI823-B-D wiring with dimming ballast or LED driver.  
Dimming Driver

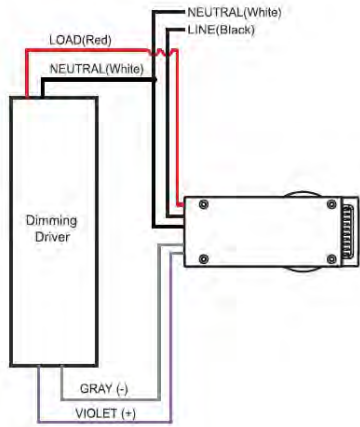

BRI823-B-D wiring with non-dimming ballast or LED driver.  
Non-Dimming Driver

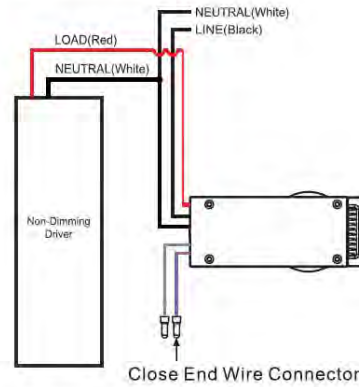

2 When the dimmable function is required, photocell should be installed on the back of lamp; When it's not required, shorting cap should be installed on the back of lamp.

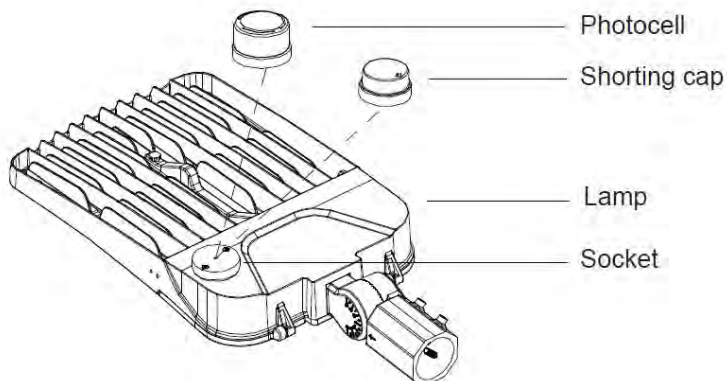

**Standard wire:**  
**L/live wire:Black\Brown; N/null wire:White\Blue; Ground wire:Green\Yellow-green.**  
**Warning/Avertissement:**