

Features & Specifications



INTENDED USE – The PLT LED wall pack combines traditional wall pack design with high-output LEDs to provide an energy-efficient, low maintenance LED wall pack suitable for replacing 400W Metal Halide fixtures. The traditional shape helps maintain building aesthetics when replacing only a portion of your building’s wall packs at a time while also eliminating unwanted markings from the removal of older fixtures. These fixtures are designed for outdoor applications such as pedestrian lighting, security lighting, and parking areas.

CONSTRUCTION – Rugged cast-aluminum housing with bronze polyester powder paint for lasting durability. Tempered glass lens protects the LEDs and provides even light distribution. Housing is sealed against moisture and environmental contaminants (IP65 rated). Designed to protect each fixture from vandalism and bad weather.

OPTICS – High-performance LEDs maintain a 9,200 Lumen output at 5000K for 54,000 hours of use. ≥80 CRI

Standard HID wall packs are reflector based luminaires. This type of fixture loses about 30% of the lamp’s Lumens within the reflector and lamp through "Lumen bounce," meaning 30% of the light never escapes the fixture. These types of lamps also lose Lumens quickly over time through a high Lumen depreciation rate. Comparatively, LED wall packs are designed to have a more directional beam angle than metal halide and high pressure sodium wall pack fixtures so no light is lost within the fixture. These fixtures also do not lose Lumens in the same way, meaning the brightness stays consistent longer, needs to be replaced far less frequently, and can replace a MH fixture that on paper has a much higher Lumen rating.

ELECTRICAL – Integral Sosen driver, Input voltage of 100-277 VAC, 50/60Hz.

INSTALLATION – Designed for wall mounting. Housing is configured for mounting directly over a standard junction box. See Installation Instruction PDF for more information.

LISTINGS – ETL Certified to safety standards for wet location. Rated for 40°C to 45°C ambient temperature. DesignLights Consortium® (DLC) qualified product. IP-65 Rated. DLC® Part Number: PLTB63211

WARRANTY – 5-year warranty. PLT products that are damaged or defective will be repaired or replaced at PLT’s choosing for a period of 5 years. Contact 1-800-624-4488 for more information.

ADD-ONS – Pair with timers, photocells, and motion sensors for hassle free bright night time lighting and energy savings during the day without needing to worry about manually turning the fixture on and off. If pairing with a photocell, it must be LED compatible in order to operate properly. If using a conventional photocell, be sure to replace it with one rated for use with LEDs. While conventional light sensors will still work with LED fixtures at first, they will burn out prematurely. The same is true for motion sensors.

If you live in the northern hemisphere, your photocells should face north whenever possible. North-facing light sensors allow for the most balanced on/off schedule based on the arc of the sun. If pointed west, it will turn on and off late and vice versa for east-facing light sensors. Photocells facing the south will be exposed to the most direct sunlight which can burn out the components and cause premature failure. If you want your lights to come on early or late, we recommend pointing the light sensor northeast or northwest, respectfully. The opposite is true south of the equator.

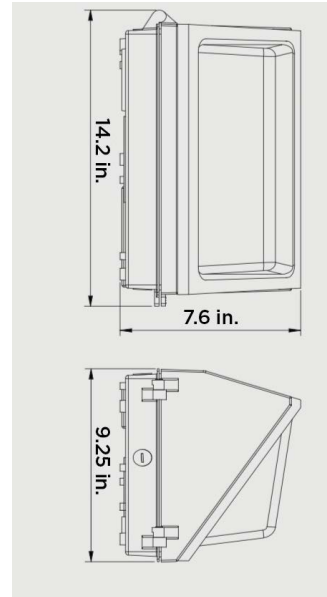

Dimensions
 Height: 7.63 in.
 Width: 14.2 in.
 Depth: 9.25 in.
 Weight: 8.04 lbs

PHOTOMETRICS

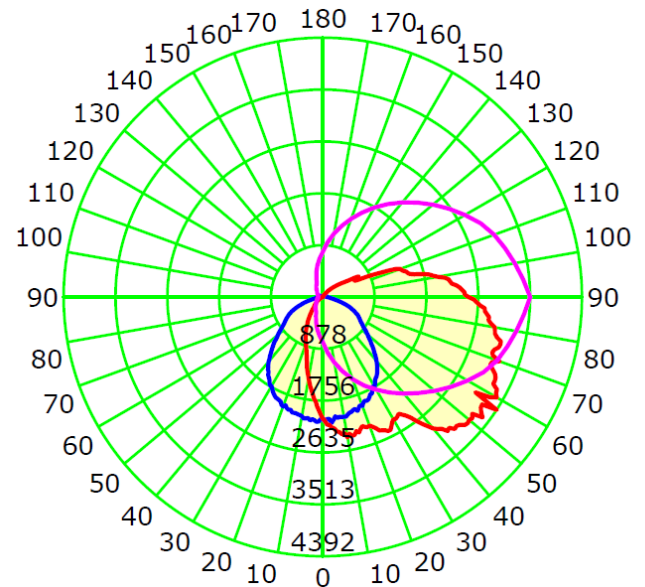

SKU #	Kelvin	Lumens	CRI	Wattage	Voltage	DLC?	Mounting	Life Hours	Warranty
PLT-11192	5000	9,200	80	75	100-277	Yes	Wall	54,000	5 Years