



SORAA BRILLIANT HL™

The Soraa Brilliant HL single-source COB lamp combines Soraa's world-class optics design and driver technology with a photopically efficacious LED

SORAA POINT SOURCE OPTICS™

With a point source and sophisticated folded optics, Soraa creates very controlled beam angles from 25 to 60 degrees, even in challenging form factors resulting in smooth uniform beams and crisp shadows

FLICKER

Soraa lamps demonstrate low levels of flicker in both dimmed and undimmed states

ENERGY EFFICIENCY AND LONG LIFE

85% more energy efficient than standard halogen lamps
 Typical payback of one year or less
 Rated lifetime to L70: 35,000hrs
 Warranty: 3yrs or 25,000hrs whichever comes first

CERTIFICATIONS

Title 20 certification pending, RoHS, CE, UL/CUL, FCC Title 47 Part 15B



RoHS



GENERAL SPECIFICATIONS

Form Factor

Width: 64mm (2.52")
 Height: 77mm (3.04")
 Weight: 160g

Operating Temperature

Minimum: -40°C (ambient)
 Typical: 70°C - 80°C (base)
 Maximum: 90°C (base)

Electrical

Wattage: 10.8W
 Power factor: 0.92
 Voltage: 120V +/- 12V
 Frequency: 50/60Hz

Dimming

Dimmable to <20%

Output Range	930 - 960 lumen
Beam Angle Range	25°, 36°, 60°
Color Metrics	CCT: 2700K, 3000K Color Rendering CIE Metrics: CRI 92, R9 50
Application	Halogen replacement for indoor and outdoor applications



HIGHLY COMPATIBLE

Thermally and geometrically compatible with standard fixtures and suitable for damp locations
 Works with trailing edge and leading edge phase cut dimmers

INTENDED USE AND APPLICATIONS

Intended for use in PAR20 compatible recessed downlights, track lighting and other indoor and outdoor applications
 Soraa lamps are designed to safely turn down in any thermal environment not conducive to minimum airflow or proper ventilation

DIMENSIONS

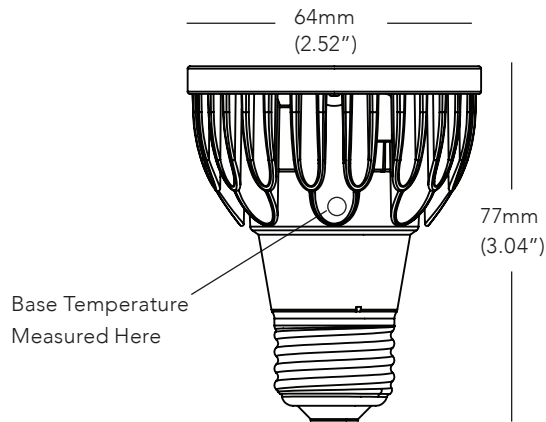

25 DEGREE BEAM

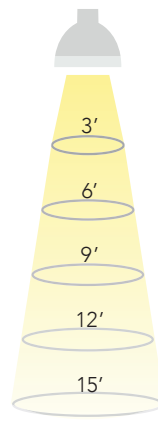

Beam Dia at 50% CBCP (ft)	Field Dia at 10% CBCP (ft)	Foot-candles (% of CBCP)
1.3	2.2	11.1%
2.7	4.4	2.8%
4.0	6.6	1.2%
5.3	8.7	0.7%
6.7	10.9	0.4%

36 DEGREE BEAM

Beam Dia at 50% CBCP (ft)	Field Dia at 10% CBCP (ft)	Foot-candles (% of CBCP)
1.9	3.5	11.1%
3.9	6.9	2.8%
5.8	10.4	1.2%
7.8	13.9	0.7%
9.7	17.3	0.4%

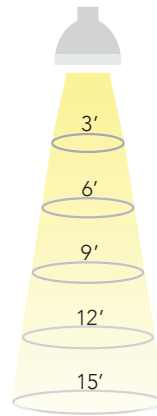

60 DEGREE BEAM

Beam Dia at 50% CBCP (ft)	Field Dia at 10% CBCP (ft)	Foot-candles (% of CBCP)
3.5	6.0	11.1%
6.9	12.0	2.8%
10.4	18.0	1.2%
13.9	24.0	0.7%
17.3	30.0	0.4%

Note: Footcandles may be calculated by multiplying the CBCP of the desired model number by the percentage in the tables above

SPECIFICATIONS BY MODEL NUMBER* SORAA LED PAR20 10.8W

Model #	Product Code	CCT (K)	Beam Angle	Field Angle	CBCP (Cd)	Halogen Equiv	Total Flux (Lm)	Efficacy (Lm/W)	CRI	McA	Title 20
BRILLIANT HL SERIES											
SP20-11-25D-827-H1	08795	2700	25	40	4185	90	930	87	92	3	pending
SP20-11-36D-827-H1	08797	2700	36	60	2325	90	930	87	92	3	pending
SP20-11-60D-827-H1	08799	2700	60	90	930	90	930	87	92	3	pending
SP20-11-25D-830-H1	08803	3000	25	40	4320	90	960	90	92	3	pending
SP20-11-36D-830-H1	08805	3000	36	60	2400	90	960	90	92	3	pending
SP20-11-60D-830-H1	08807	3000	60	90	960	90	960	90	92	3	pending

CCT: Correlated Color Temperature **McA:** White Point Accuracy in McA step **SNAP:** SORAA SNAP System Compatible

*Specifications are at stable warm operating conditions (25°C ambient)

SERIES/CCT

COLOR ACCURACY

SPECTRAL POWER DISTRIBUTION

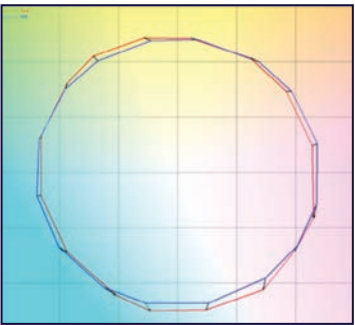
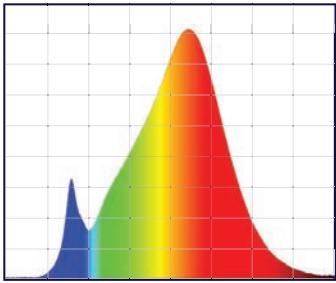
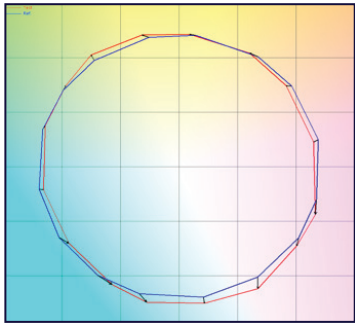
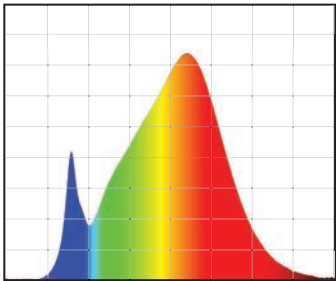
<p>BRILLIANT HL 2700K</p>	 <p>Rf: 90, Rg: 98, Rfh1: 85</p>	 <p>380 Wavelength (nm) 780</p> <p>CRI: 92, R9: 50</p>
<p>BRILLIANT HL 3000K</p>	 <p>Rf: 90, Rg: 98, Rfh1: 85</p>	 <p>380 Wavelength (nm) 780</p> <p>CRI: 92, R9: 50</p>

Rf: TM-30 metric measuring color fidelity (whether colors are similar to those under natural light). Rf is a more accurate version of the CRI Ra. Rf is 100 for natural light.
 Rg: TM-30 metric measuring color gamut (whether colors are more saturated than under natural light). Rg is 100 for natural light.
 Rfh1: TM-30 metric measuring color fidelity for red tones. Rfh1 is a more accurate version of the CRI R9. Rfh1 is 100 for natural light.