



LED ET8-1150H-20

Part #: ELT8/D/20W/2400/120D/50K/G13/HD/A+B Lamp Class: T8 (4 ft.)



Product Description

LED ET8-1150H-20 delivers superior brightness, valuable energy savings and long lasting performance. **EURI™** 4 ft. Hybrid T8 LED lamp is ideal for offices, conference rooms, hotels, academic complexes, research buildings, medical facilities and commercial stores. Hybrid technology reduces maintenance expenses and allows adaptable installation methods whether a ballast is present or not. (Single ended installation is highly recommended. Certified electrician support is required for bypass ballast installation.) Available in 4000K *Bright White* and 5000K *Cool White*. Enjoy features such as: instant on, shatter resistance and mercury free.



Estimated Energy Cost: \$2.41 per year

*Note: Design, features and specifications subject to change without notice. Some features may not be available on all models. Please visit www.eurilighting.com or call 1-888-743-5766 for more information.

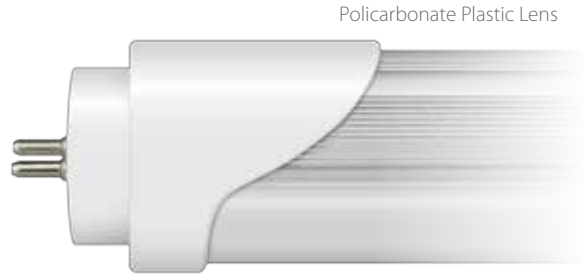

LED Hybrid Tube

Hybrid technology reduces maintenance expenses and allows adaptable installation methods whether a ballast is present or not

Specifications

Input Power	Input Voltage	Lumen Output	Beam Angle	Center Beam	CCT
20 W	AC100-277 V	2400 lm	120°	618 cd	5000 K
CRI	Luminous Efficacy	Power Factor	Input Current	Base/Cap	Lamp Lifespan
83	120 lm/W	0.9	0.08 A	G13	50,000 Hrs.

Product Features

- Non-Dimmable
- Instant-On/Off
- Mercury Free
- Energy Efficient

Product Dimensions

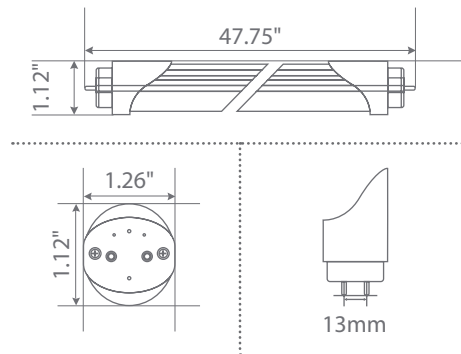

Product Photometric Data

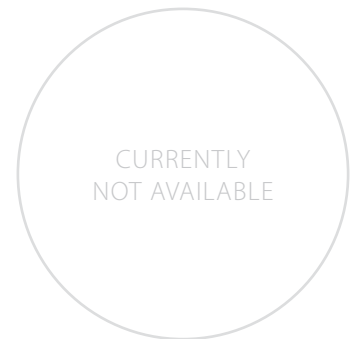

Euri Lighting | A Division of **IRTRONIX** Inc.

20900 Normandie Avenue Suite B Torrance, CA 90502 | Tel: 888.743.5766 | Fax: 310.787.1166 | www.eurilighting.com
 ©2017 Euri Lighting. All Rights Reserved