



I-232

SERIES D
PARALLEL OPERATION
EMERGENCY LIGHTING
EQUIPMENT

INSTRUCTION MANUAL

IMPORTANT SAFEGUARDS

When using electrical equipment, basic safety precautions should always be followed, including the following:

READ AND FOLLOW ALL SAFETY INSTRUCTIONS

1. **CAUTION** – To prevent electrical shock, do not mate unit connector until installation is complete and A.C. power is supplied to the unit.
2. **CAUTION** – This fixture provides more than one power supply output source. To reduce the risk of electrical shock, disconnect both normal and emergency sources by turning off the A.C. branch circuit and by disconnecting the unit connector.
3. **CAUTION** – This is a sealed unit. The integral, high temperature Ni-Cad battery is not replaceable. Replace the entire unit when necessary and recycle or dispose of the nickel-cadmium battery properly.
4. **DO NOT USE OUTDOORS.** The I-232 is for use with grounded, UL Listed, damp location rated, indoor fixtures. Not for use in heated air outlets or hazardous locations.
5. The I-232 requires an unswitched A.C. power source of either 120 or 277 volts. Properly cap the unused A.C. lead.
6. The I-232 and A.C. ballast *must* be on the same branch circuit.
7. Do not mount near gas or electric heaters.
8. The I-232 should be mounted in locations and at heights where it will not readily be subjected to tampering by unauthorized personnel.
9. The I-232 is suitable for mounting in the ballast compartment or on top of the fixture. For top mount, order optional mounting kit TMK-80. The I-232 requires two (2) TMK-80s; one for each end of the unit. When used in conjunction with enclosed and gasketed fixtures, the I-232 is suitable for mounting in the ballast compartment only.
10. The I-232 will cold strike and operate *two* 4' instant start, rapid start, U shape or circline, T8 through T12 fluorescent lamps.
11. The I-232 operates lamps at reduced output as follows: two 4' lamps for 90 minutes. The I-232 is compatible with all A.C. ballasts (including multiple lamps).
12. Suitable for use in damp locations and in enclosed and gasketed fixtures.
13. For use in 0° C minimum, 50° C maximum ambient temperatures.
14. The use of accessory equipment not recommended by the manufacturer may cause an unsafe condition, void warranty, and result in non-compliance with UL specifications.
15. Do not use this equipment for other than intended use.
16. Install in accordance with the National Electrical Code and local regulations.
17. Installation and servicing should be performed by qualified personnel.
18. Lighting fixture manufacturers, electricians and end users need to ensure product system compatibility before final installation.

SAVE THESE INSTRUCTIONS



THIS UNIT CONTAINS A
RECHARGEABLE NICKEL-CADMIUM BATTERY.
PLEASE RECYCLE OR DISPOSE OF PROPERLY.

INSTALLATION INSTRUCTIONS

CAUTION: Before installing, make certain the A.C. power is off and the I-232 unit connector is disconnected.

1. MOUNTING THE I-232

Remove the ballast channel cover. For heat consideration, mount the **I-232** in the ballast channel as far away from the A.C. ballast(s) as possible. The **I-232** may also be mounted on top of the fixture. The optional top mounting kit (catalog no. TMK-80) may be ordered separately from Customer Service.

When battery packs are remote mounted, consult Customer Service for the maximum allowable distance between the battery pack and lamps.

2. WIRING

Refer to the wiring diagrams on the back page for the appropriate wiring of lamps and ballast. Install in accordance with the National Electrical Code and local regulations. For additional wiring diagrams consult Customer Service.

3. INSTALLING THE CHARGE INDICATOR

Recessed Troffer Fixture – Select a convenient location with proper clearance in the ballast cover and drill or punch a $\frac{7}{8}$ " hole ($\frac{1}{2}$ " knockout). Insert the $\frac{7}{8}$ " bushing into the hole. Push the plastic tube through the bushing. Disconnect the leads from the **LED** housing and route the leads down the plastic tube. Reconnect the leads to the housing, observing the proper polarity (Red/Black or Red lead w/connector to positive (+) red tab). Push the entire assembly back into the tube until the lens collar rests against the plastic tube. The plastic tube should be adjusted so that the **Charge Indicator** is within $\frac{1}{4}$ " of the fixture lens. The **Charge Indicator** must be visible after installation. Refer to *Illustration 1*.

Strip Fixture – Select a convenient location on the side of the fixture so the **Charge Indicator** can be seen after installation. Allow for proper clearance inside the fixture and drill or punch a $\frac{1}{2}$ " hole. Disconnect the leads from the **LED** housing. Push the **LED** housing into the $\frac{1}{2}$ " hole until it is firmly locked in place. Reconnect the leads, observing the proper polarity (Red/Black or Red lead w/connector positive (+) red tab). Refer to *Illustration 2*.

Illustration 1 Recessed Troffer Fixture

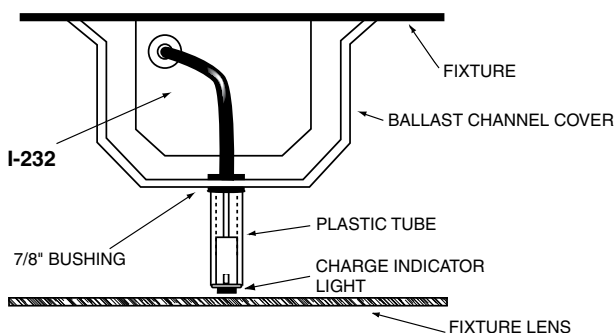
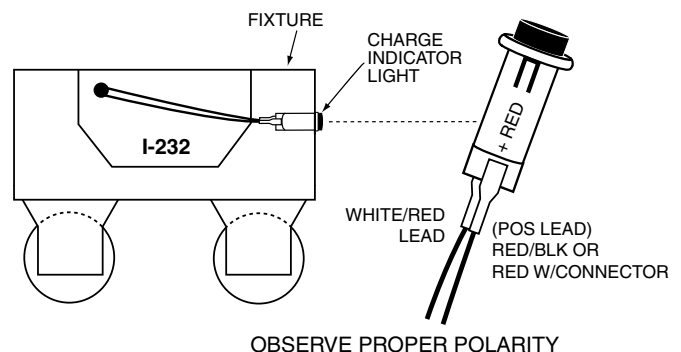

Illustration 2 Strip Fixture



4. INSTALLING THE TEST SWITCH

The **Test Switch** should be mounted on the ballast channel cover of a recessed troffer, or on the side of a strip fixture, preferably adjacent to the **Charge Indicator**. Drill or punch a $\frac{1}{2}$ " mounting hole.

Note: For proper operation, use only the accessory components provided with the unit. See Page 1 of the *Instruction Manual*.

5. WIRING THE A.C. INPUT

- A. The **I-232** and A.C. ballast **must** be on the same branch circuit.
- B. The **I-232** requires an **unswitched** A.C. power source of either 120 or 277 volts. Select the proper voltage lead and cap the unused lead.
- C. When the **I-232** is used with a switched fixture, the A.C. input to the **I-232** must be connected ahead of the fixture switch. Refer to *Illustration 3* for switched and unswitched fixture wiring diagrams.

Illustration 3

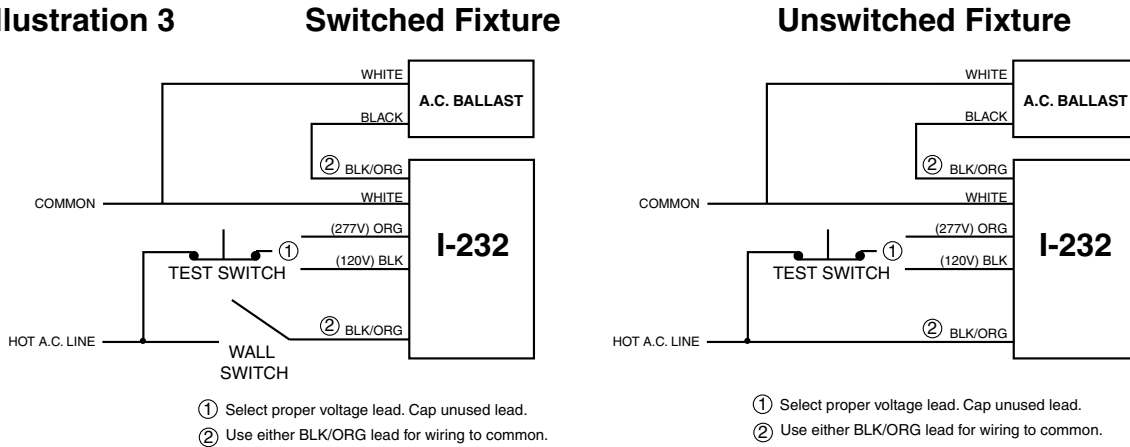

6. LABELS

Attach the appropriate labels adjacent to the **Test Switch** and **Charge Indicator**. Annotate Re-lamping label for lamp type and wattage. The Caution and the Re-lamping labels must be on the fixture in a readily visible location to anyone attempting to service the fixture.

7. COMPLETING INSTALLATION

When the installation is complete, switch the A.C. power on and join the **I-232** unit connector.

OPERATION

Normal Mode – A.C. power is present. The A.C. ballast operates the fluorescent lamp(s) as intended. The **I-232** is in the standby charging mode. The **Charge Indicator** will be lit providing a visual indication that the battery is being charged.

Emergency Mode – The A.C. power fails. The **I-232** senses the A.C. power failure and automatically switches to the *Emergency Mode*. Two lamps are illuminated, at reduced output, for a minimum of 90 minutes. When the A.C. power is restored, the **I-232** switches the system back to the *Normal Mode* and resumes battery charging. See page 1 of the Instruction Manual.

TESTING & MAINTENANCE

Initial Testing – Allow the unit to charge approximately 1 hour, then conduct a short discharge test. Allow a 24 hour charge before conducting a one hour test.

The **I-232** is a maintenance free unit, however, periodic inspection and testing is required. NFPA 101, Life Safety Code, outlines the following schedule:

Monthly – Insure that the **Charge Indicator** light is illuminated. Conduct a 30 second discharge test by depressing the **Test Switch**. Two lamps should operate at reduced output.

Annually – Insure that the **Charge Indicator** light is illuminated. Conduct a full 1½ hour discharge test. The unit should operate as intended for the duration of the test.

“Written records of testing shall be kept by the owner for inspection by the authority having jurisdiction.”

SERVICING SHOULD BE PERFORMED BY QUALIFIED PERSONNEL.

Consult Customer Service for current warranty information.

TYPICAL WIRING DIAGRAMS

For wiring diagrams of ballasts not shown, consult our Customer Service.

Wiring and Troubleshooting Tips are available on-line

1. TWO LAMP

RAPID START BALLAST

* Operates in A.C. and emergency mode.

- ① Select proper voltage lead. Cap unused lead
- ② Do not mate connector until installation is complete and A.C. power is supplied.
- ③ Test accessory leads - refer to installation instructions for proper polarity wiring.
- ④ No polarity on BLK/ORG leads.
- ⑤ Switched or unswitched line - refer to installation manual for hot and test switch placement

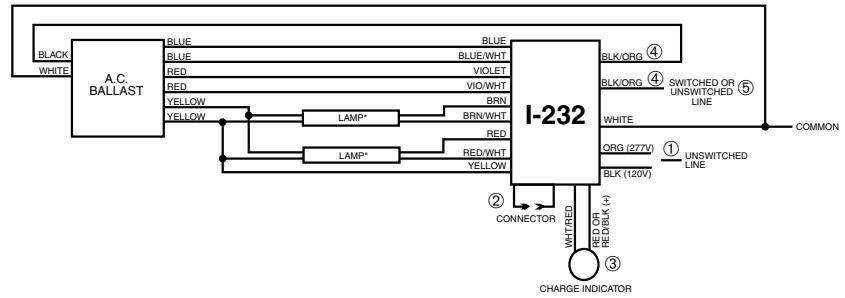

2. THREE LAMP

RAPID START BALLAST

* Operates in A.C. and emergency mode.

- ① Select proper voltage lead. Cap unused lead
- ② Do not mate connector until installation is complete and A.C. power is supplied.
- ③ Test accessory leads - refer to installation instructions for proper polarity wiring.
- ④ No polarity on BLK/ORG leads.
- ⑤ Switched or unswitched line - refer to installation manual for hot and test switch placement

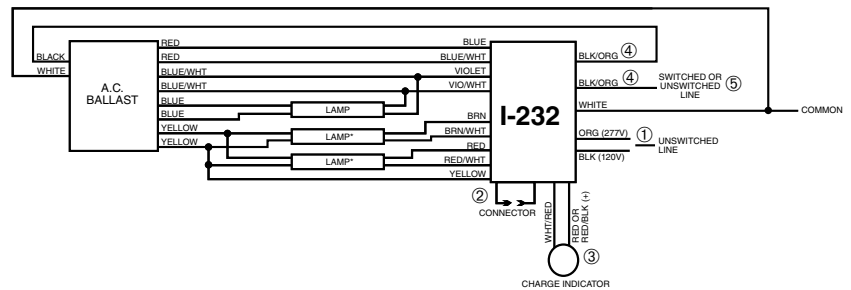

3. TWO LAMP

INSTANT START BALLAST

* Operates in A.C. and emergency mode.

- ① Select proper voltage lead. Cap unused lead
- ② Do not mate connector until installation is complete and A.C. power is supplied.
- ③ Pigtail leads together
- ④ Test accessory leads - refer to installation instructions for proper polarity wiring.
- ⑤ No polarity on BLK/ORG leads.
- ⑥ Switched or unswitched line - refer to installation manual for hot and test switch placement

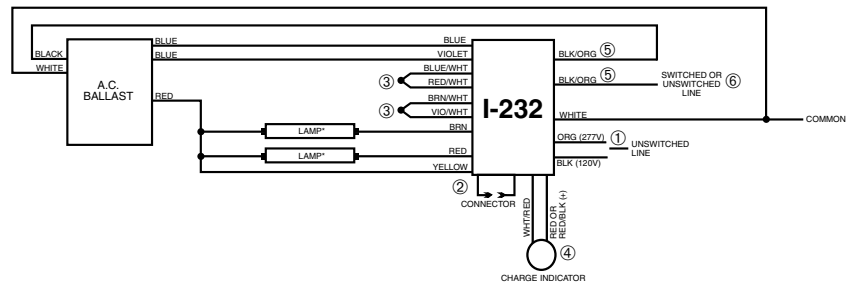

4. THREE LAMP

INSTANT START BALLAST

* Operates in A.C. and emergency mode.

- ① Select proper voltage lead. Cap unused lead
- ② Do not mate connector until installation is complete and A.C. power is supplied.
- ③ Pigtail leads together
- ④ Test accessory leads - refer to installation instructions for proper polarity wiring.
- ⑤ No polarity on BLK/ORG leads.
- ⑥ Switched or unswitched line - refer to installation manual for hot and test switch placement

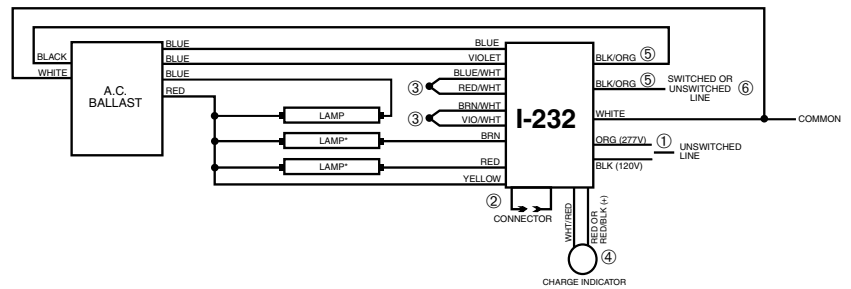

5. FOUR LAMP

INSTANT START BALLAST

* Operates in A.C. and emergency mode.

- ① Select proper voltage lead. Cap unused lead
- ② Do not mate connector until installation is complete and A.C. power is supplied.
- ③ Pigtail leads together
- ④ Test accessory leads - refer to installation instructions for proper polarity wiring.
- ⑤ No polarity on BLK/ORG leads.
- ⑥ Switched or unswitched line - refer to installation manual for hot and test switch placement

