

Features & Specifications

INTENDED USE – LED area lights are all-purpose site lighting fixtures that can be used for parking lots, car dealerships, outdoor stadiums, pathways, and parks. These LED fixtures will yield a significant reduction in energy consumption compared to standard HID systems and virtually eliminate ongoing maintenance expenses with a long-lasting lifespan. Designed for outdoor applications, the LED area light fixtures will provide reduced offsite visibility as well as effective security lighting.

CONSTRUCTION – Heavy-duty die cast aluminum housing with bronze polyester powder paint for corrosion-free durability. Resistant to rough vibrations and external impacts. Acrylic lens protects the LEDs and provides even light distribution. Housing is sealed with a silicone gasket, protecting against moisture and environmental contaminants (IP68 rated). Modular LED bricks wired in parallel for ease of maintenance.

OPTICS – High-performance LEDs maintain a 14,400 Lumen output at 5000K for 50,000 hours of use. ≥70 CRI.

Type V light distribution is designed for large open spaces like intersections, large parking lots, and roadway medians, type V light distributions direct light in a circular or square pattern in all directions around the fixture. This light distribution type is best suited for large open spaces like roadway medians and intersections, large parking lots, and anywhere an evenly spread pattern of light is required.

LED area lights are designed to have a more directional beam angle than metal halide and high pressure sodium fixtures so no light is lost within or above the fixture. These LED fixtures also do not lose Lumens in the same way as a HID fixture, meaning the brightness stays consistent longer and needs to be replaced far less frequently.

ELECTRICAL – Input voltage of 120-277 VAC, 50/60Hz. Consider adding a surge protector to protect your fixtures from power surges in your electrical system as an added insurance policy to your investment.

INSTALLATION – A straight-arm mounting bracket makes retrofit installation simple, resulting in reduced installation time and additional labor savings. Adjustable slipfitter is included for round pole mounting applications. Slipfitter mounts provide more flexibility and control over installation and light distribution by offering a broader range of angles than a stationary arm.

LISTINGS – UL Certified to safety standards for wet location. Rated for -40°C to 45°C ambient temperature. IP-68 Rated.

WARRANTY – 5-year warranty. PLT products that are damaged or defective will be repaired or replaced at PLT's choosing for a period of 5 years. Contact 1-800-624-4488 for more information.

ADD-ONS – Pair with timers, photocells, and motion sensors for hassle free bright night time lighting and energy savings during the day. If pairing with a photocell, it must be LED compatible in order to operate properly. If using a conventional photocell, be sure to replace it with one rated for use with LEDs. While conventional light sensors will still work with LED fixtures at first, they will burn out prematurely. The same is true for motion sensors.

If you live in the northern hemisphere, your photocells should face north whenever possible. North-facing light sensors allow for the most balanced on/off schedule based on the arc of the sun. If pointed west, it will turn on and off late and vice versa for east-facing light sensors. Photocells facing the south will be exposed to the most direct sunlight which can burn out the components and cause premature failure. If you want your lights to come on early or late, we recommend pointing the light sensor northeast or northwest, respectfully. The opposite is true south of the equator.



Dimensions

Height: 13.06 in.

Width: 12.31 in.

Depth: 2.5 in.

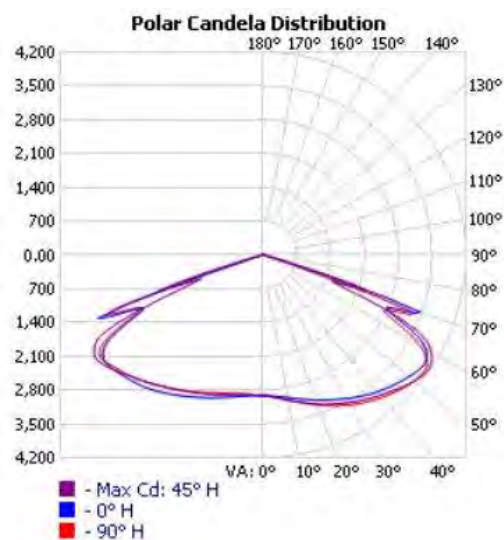

SKU #	Kelvin	Lumens	Wattage	Voltage	CRI	DLC?	Mounting	Life Hours	Warranty
KIT-10057	5000	14,400	120	120-277	70	YES	ARM & SLIPFITTER	50,000	5 YEAR

PHOTOMETRICS

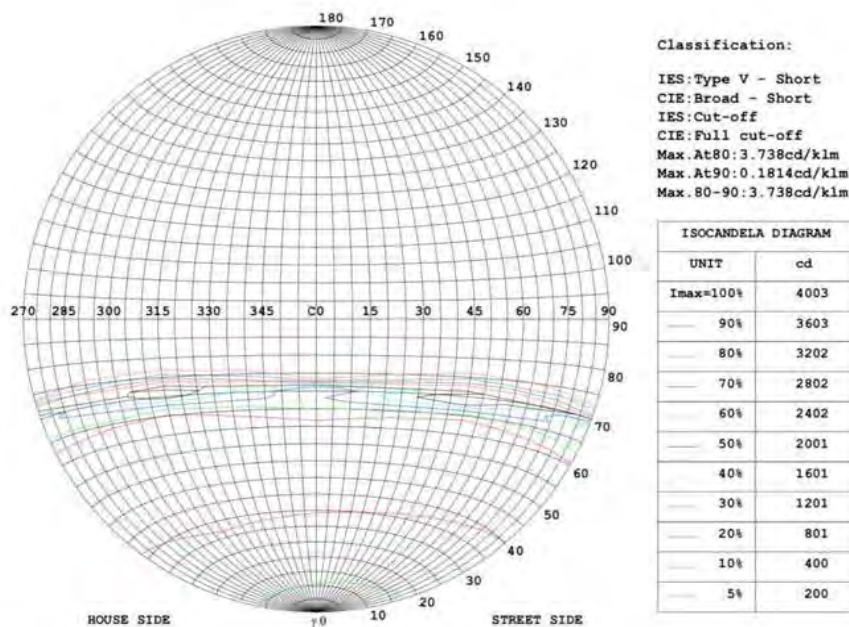
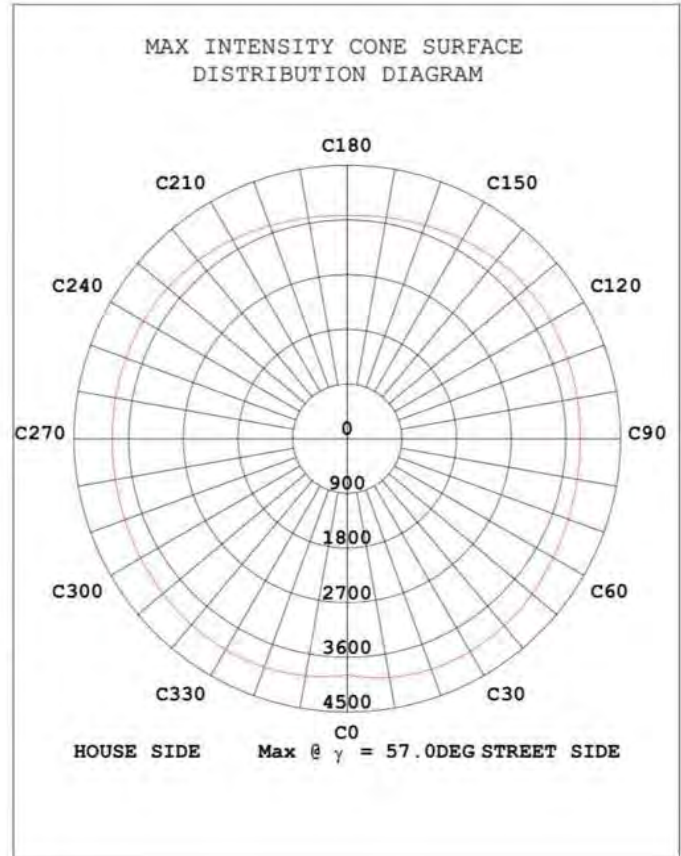
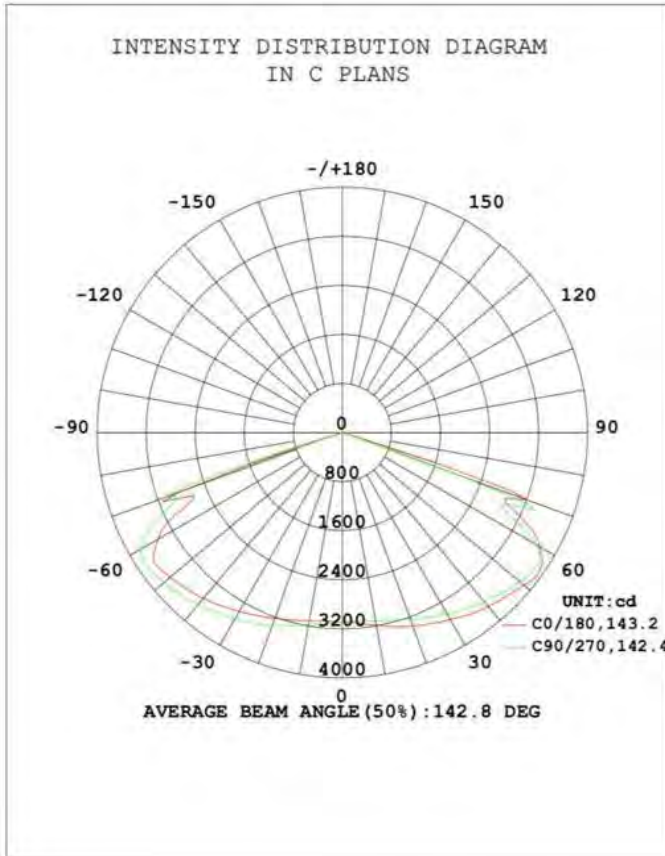

LED AREA LIGHTS

&

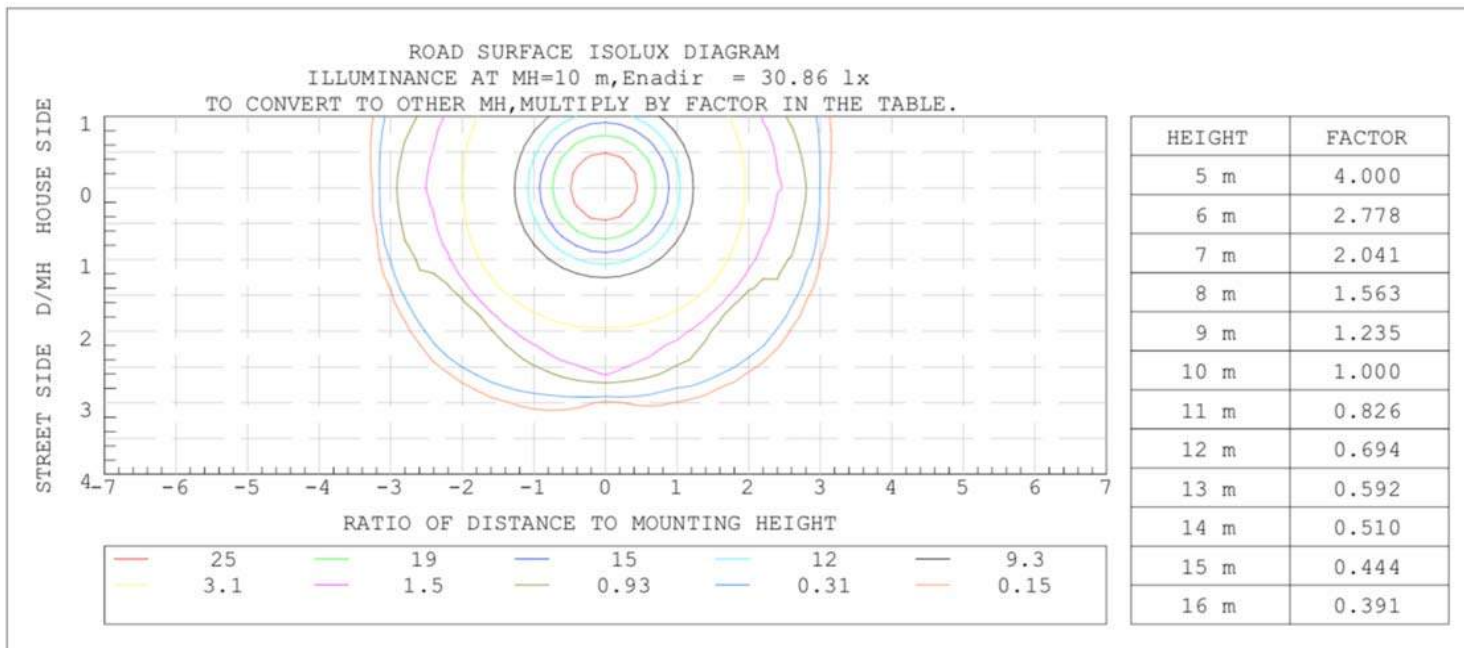
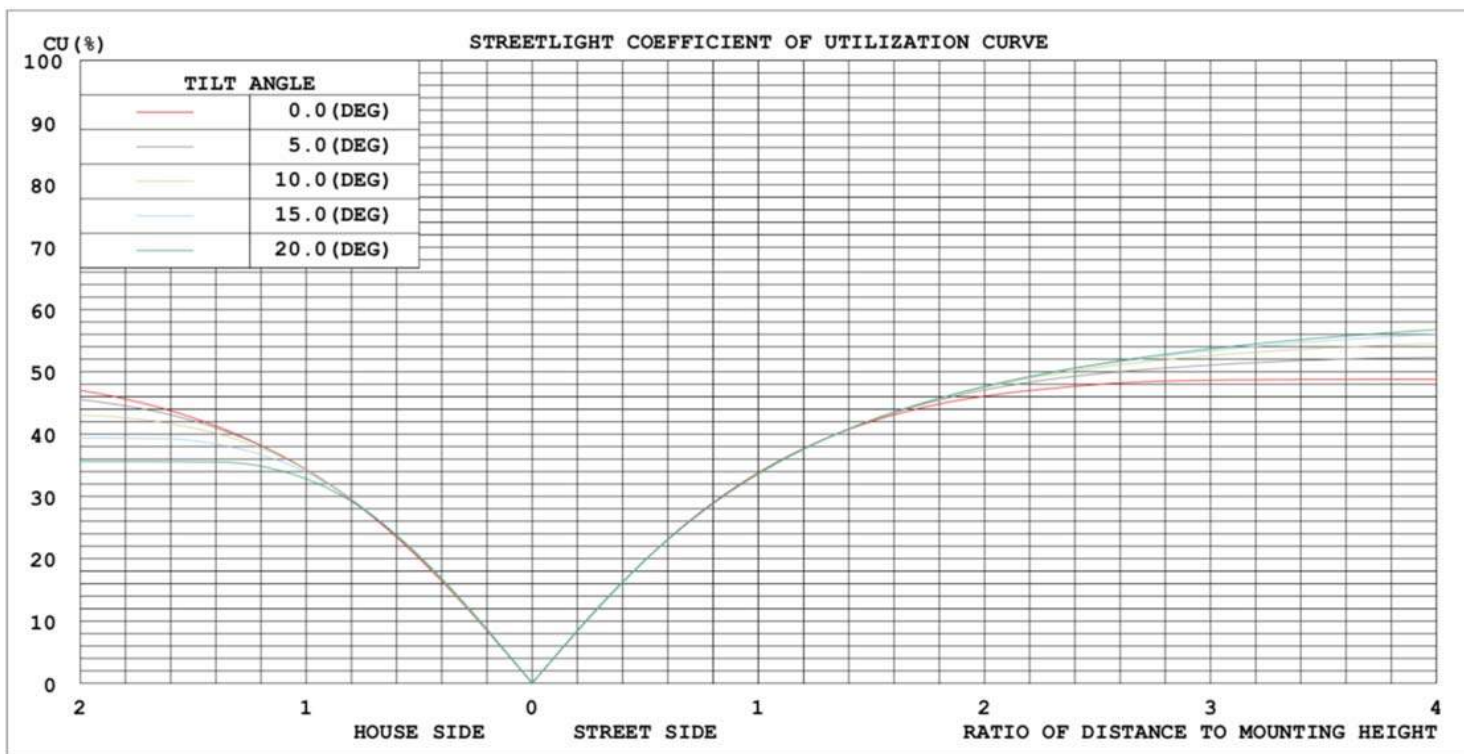

LED AREA LIGHTS

&

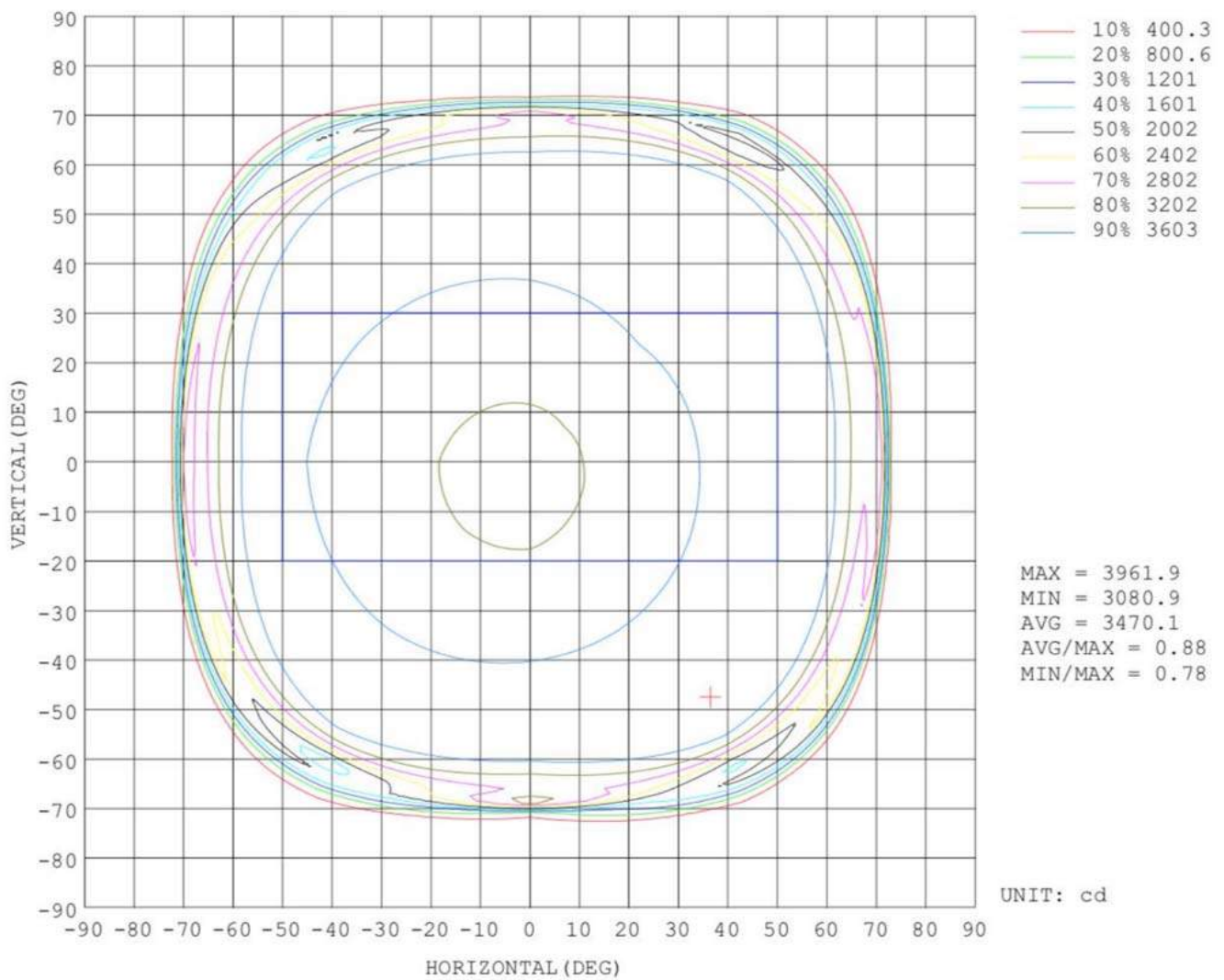

LED AREA LIGHTS

&

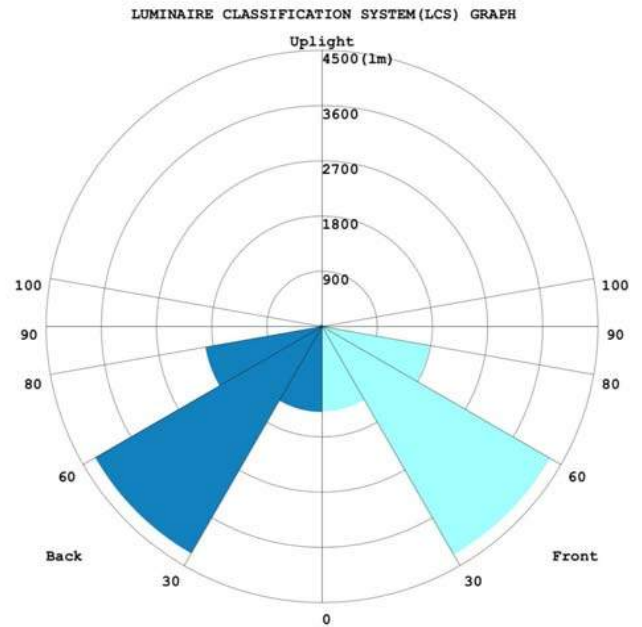
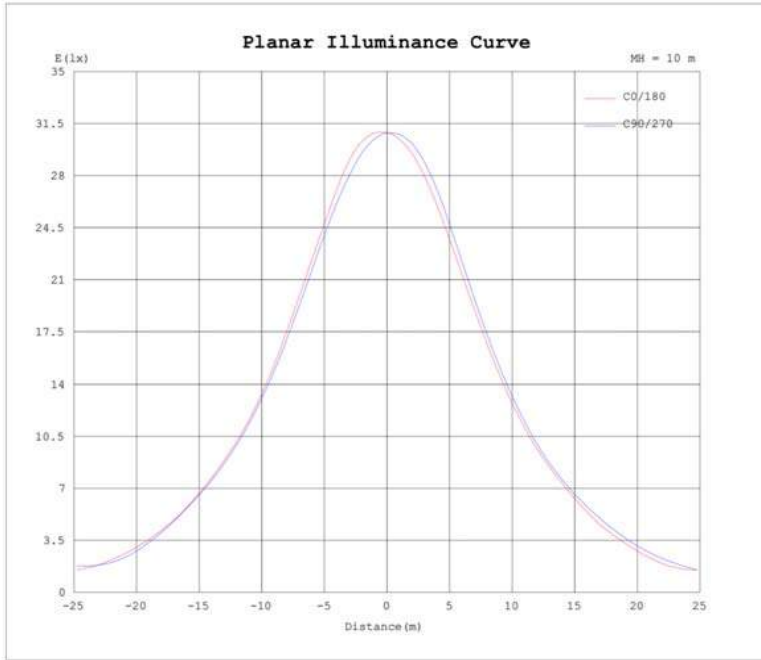

Improved LED Modules design

- ** No soldering on production line, assembly speed fastened
- ** Plug-in pin for LED modules, easy assembly & replace in future
- ** Temp of LED Board: 60° C (Ambient Temp=25° C)

LED Lens

- ** Type III, Type V, 90x120°
- ** With small pins on the back side for locating the connection hole on the LED board, to avoid wrong direction assembly.

Waterproof apron for LED modules.

Extruded aluminum heat sink, coefficient of heat transfer up to 221

- ** Heat dissipation trippled than before
- ** Lighter weight
- ** LED Modules can directly connected to heat sink, the temp difference between is only 2-3° C
- ** Temp for heat sink= 60° C (Ambient Temp=25° C)

Die-casting aluminum power pack

- ** Reliable structure
- ** Better for IP rating
- ** Isolates the heat generated from the LED Modules to power supply
- ** Simple but reliable way to fix driver, easy to replace in future.

Patent, Unique slide-in Mount installation

- ** Ideal for inventory
- ** Ideal for SKD
- ** Easy installation
- ** Save labor cost
- ** Will not affect light, power & IP rating when changing the mount.

Clamshell power supply cover
Much more convenient for installation, save labor cost.

STRAIGHT ARM



Square Pole

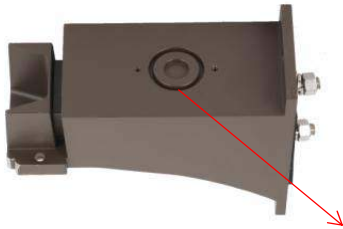

- ◆ Slide-in straight mount option for square pole installation **or directly for wall installation**
- ◆ Min Pole Size: 3"x3"
- ◆ Max Load Weight: 110lbs
- ◆ Reserved for photosensor option



STANDARD MOUNT-SLIP FITTER



- ◆ Installation angle: 0-90°
- ◆ Max Pole size: 2-3/8"
- ◆ Each rotation is 4°
- ◆ Max Load Weight: 110lbs
- ◆ Installation: for round pole

