

LED Flat Panel Surface Mount Kits

Applications

TCP's FPSK1, FPSK2 and FPSK4 surface mount kits are an accessory designed especially for TCP LED Flat Panels. These kits provide an aesthetically pleasing style and an ultra low-profile silhouette. Ideal for field installation on insulated or non-insulated sheet rock ceilings.

Construction

- Durable 18 gauge aluminum frame; 0.067" thick (1.7mm)
- Post-painted in white powder coat paint
- Easy-to-assemble for quick field installation
- Ultra low-profile design
- Can accommodate TCP LED Flat Panels with or without emergency back-up option
- Surface mount kits made in the USA

Compliance

- cULus Recognized Luminaire Fitting
- Kits were UL tested with TCP LED Flat Panels to ensure compatibility

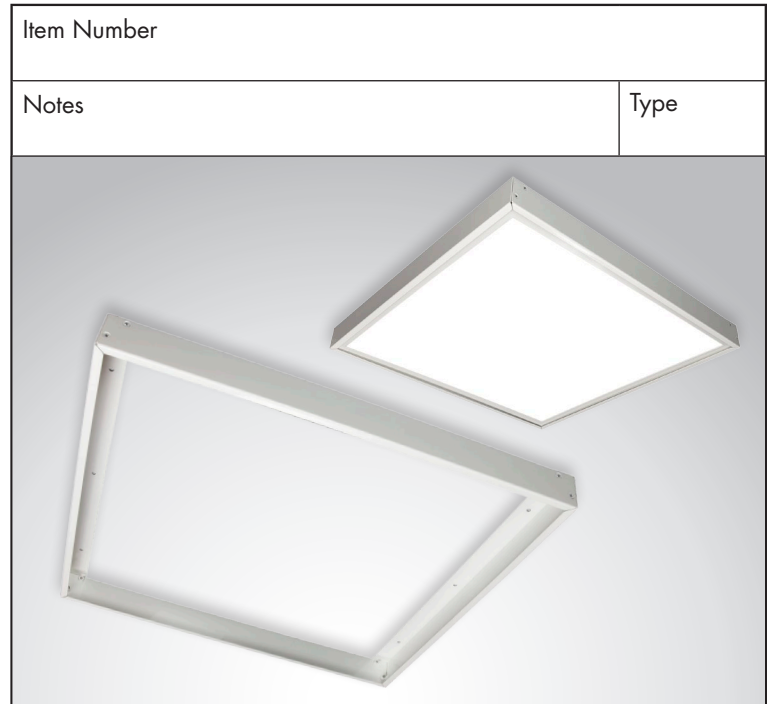

<p>Listings cULus – damp location listed RoHS Compliant Made in the USA</p> <p>Warranty Five year limited warranty against defects in manufacturing</p>

Catalog Ordering Matrix (kits ordered as accessory sold separately)

TCP Item #	SIZE	DIMENSIONS (L x W x D)	WEIGHT (does not include fixture weight)	FINISH	TCP LED FLAT PANEL COMPATIBILITY (TCP Model #s)
FPSK1	1x4	48" 12" x 2.13" (1219mm x 300mm x 54mm)	2.6 lbs. (1.18 kg)	White	TCPP1 TCPP1EB
FPSK2	2x2	24" x 24" x 2.13" (609mm x 609mm x 54mm)	1.9 lbs. (0.86 kg)	White	TCPP2 TCPP2EB
FPSK4	2x4	48" x 24" x 2.13" (1219mm x 609mm x 54mm)	3.0 lbs. (1.36 kg)	White	TCPP4 TCPP4EB

Dimensions and Weight

FPSK1 – 1x4 Kit

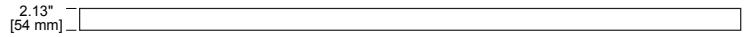
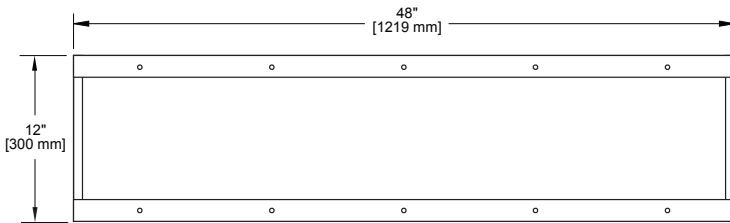

Length: 48" (1219mm)
Width: 12" (300mm)
Depth: 2.13" (54mm)
Weight: 2.6 lbs. (1.18kg)

FPSK2 – 2x2 Kit

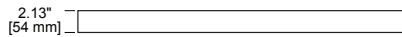
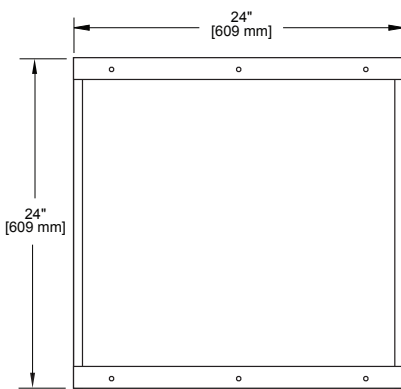

Length: 24" (609mm)
Width: 24" (609mm)
Depth: 2.13" (54mm)
Weight: 1.9 lbs. (0.86kg)

FPSK4 – 2x4 Kit

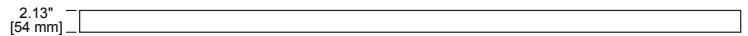
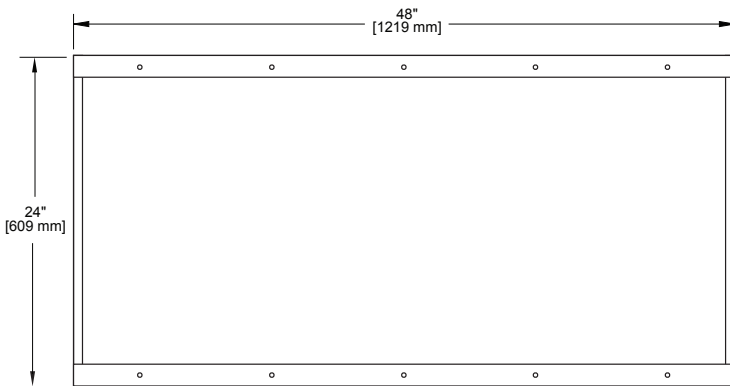

Length: 48" (1219mm)
Width: 24" (609mm)
Depth: 2.13" (54mm)
Weight: 3.0 lbs. (1.36kg)