

MD-SERIES

MAGNETIC DIMMABLE LED DRIVER



P/N: MD-200-24



KLUS - MD-200-24 is the most compact LED driver on the market with a magnetic transformer core. It is equipped with two push-to-reset circuit breakers on the input and output, which protect both the load and driver. The driver is encased in a coated metal box that includes 2 knock-outs on the bottom to enable easy installation that complies with electrical code requirements.

QUICK SPECS

Input Voltage	Max Output Power	Output Voltage	Output Current	Efficiency @ Max Load	Power Factor @ Max. Load	Envir. Protection Rating	Weight
120VAC	200W	24VDC	10.9 A	> 87%	> 0.93	NEMA 3R	87oz

WIRING DIAGRAM

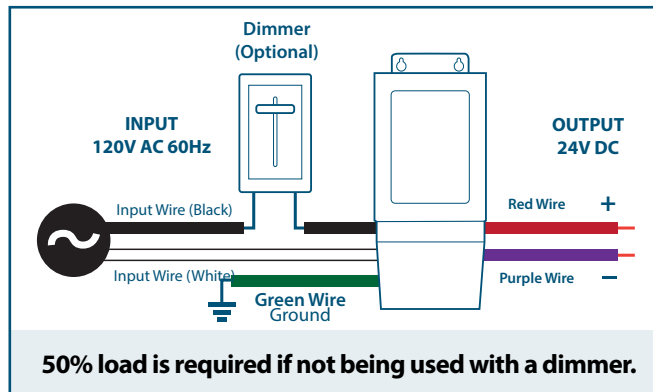

FEATURES

- Dimmable with any standard MLV/Incandescent TRIAC- (Leading edge) dimmer switch
- Dual protection - two manual push-to-reset circuit breakers on the primary and secondary sides
- Low operating temperature
- Nema 3R - Outdoor Use
- Two bottom knock-outs
- Optional 10% voltage boost to compensate for voltage drop
- ETL Listed
- Certified to CSA Standard

ENCLOSURE DETAILS In. (mm)

Length	10.06 (255.5)
Width	3.09 (78.5)
Height	2.84 (72.1)

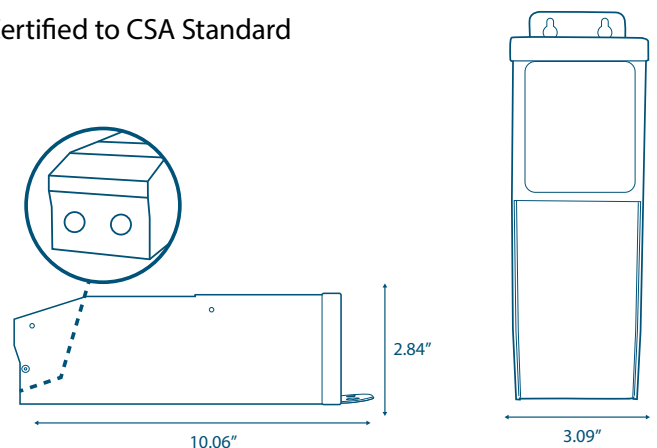

MD-SERIES MAGNETIC DIMMABLE LED DRIVER

SPECIFICATIONS

Input	
Input Voltage	120VAC
Input Current @ Max Load	2.51 A
Power Factor	0.93
Efficiency	> 87%
Output	
Max Load	200W
Output Voltage	23.3 VDC
Output Current @ Max Load	10.9 A
Open Circuit Output Voltage	26.2 VDC
Coil Former	Double Section Bobbin
Environmental	
Operating Temperature	-30°C - 45°C (-22°F - 113°F)
Min Installation space between drivers	5" Inch
Thermal Class	B130°C
Protections	
Circuit Breaker	Primary and secondary push to reset
Mechanical & Housing	
Leads Primary	PVC 600V #18
Leads Secondary	PVC 300V #12
Length	10.06" (255.5mm)
Width	3.09" (78.5mm)
Height	2.84" (72.1mm)
Weight	87oz
Housing Material	Coated metal
Housing Color	Black
Junction Box	Yes
Mounting	Two Hole flange mounting
Approval Markings	
Certificates / Approval Signs	UL 8750

MD-SERIES MAGNETIC DIMMABLE LED DRIVER

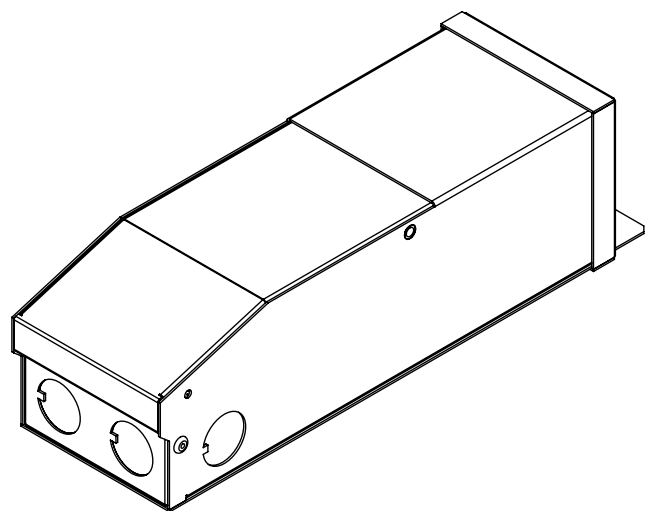
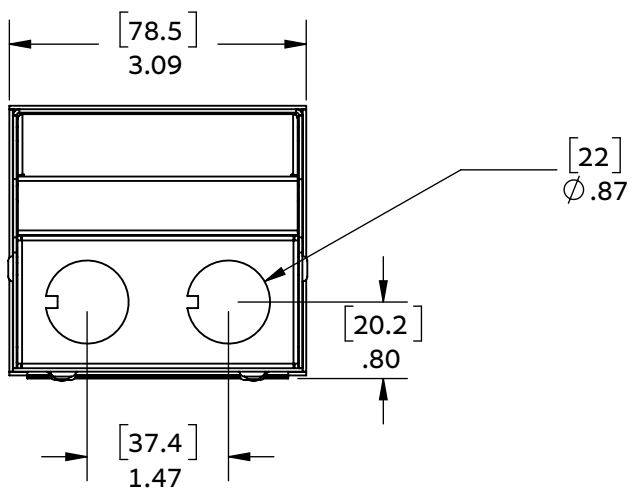
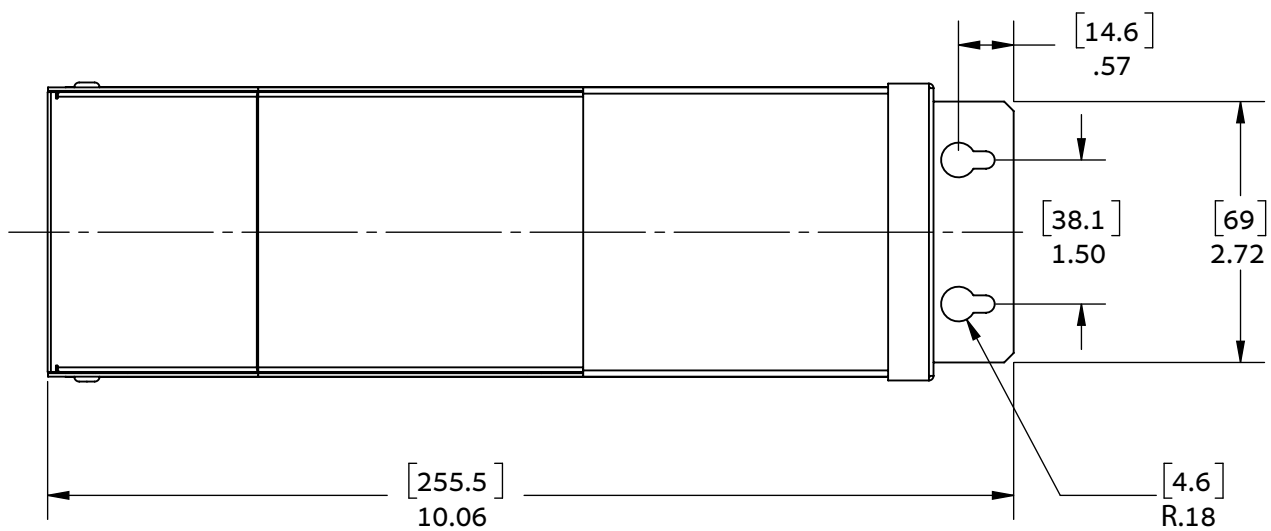

MD-SERIES MAGNETIC DIMMABLE LED DRIVER

